



2022 Nevada School Bus Driver Training Manual

NEVADA STATE BOARD OF EDUCATION

2022-2023 Members

Felicia Ortiz, President

Mark Newburn, Vice President

Joe Arrascada

Katie Coombs

Dr. Katherine Dockweiler

Tim Hughes

Tamara Hudson

Malia Poblete

Mike Walker

Dr. Summer Stephens

Dr. Rene Cantu

Vision Statement

All Nevadans ready for success in the 21st Century

Mission

To improve student achievement and educator effectiveness by ensuring opportunities, facilitating learning, and promoting excellence.

Purpose

[NRS 385.075](#) requires the State Board establish policies to govern the administration of all functions of the State relating to supervision, management and control of public schools not conferred by law on some other agency. [NRS 386.825](#) requires the State Board adopt regulations for school bus driver qualifications and training. The Nevada School Bus Driver Training Manual is the State Board of Education approved training document for all school bus drivers in Nevada. The manual was approved during the Nevada State Board of Education meeting.

Nevada Department of Education

Jhone M. Ebert

Superintendent of Public Instruction

Craig Statucki

Interim Deputy Superintendent for Educator Effectiveness and Family Engagement

Dr. Jonathan P. Moore, Ed.D

Deputy Superintendent for Student Achievement

Heidi Haartz

Deputy Superintendent for Student Investment

Christy McGill

Director, Office for a Safe and Respectful Learning Environment

Jeremy Silva

Program Officer, Pupil Transportation

Acknowledgements

The Nevada Department of Education acknowledges and thanks the following Nevada school districts and private school transportation personnel for their hard work and dedication in the development of the Nevada School Bus Driver Training Manual.

Carson City School District

Churchill County School District

Clark County School District

Douglas County School District

Elko County School District

Esmeralda County School District

Eureka County School District

Humboldt County School District

Lander County School District

Lincoln County School District

Lyon County School District

Mineral County School District
Nye County School District
Pershing County School District
Pyramid Lake
Storey County School District
Washoe County School District
White Pine County School District
The Meadows School
Yeshiva Day School

Contents

Class B / Endorsement (S) and (P) Theory Instruction Curriculum	6
ELDT Requirements.....	6
Section 1.1 Basic Operation	7
Unit 1.1.1 Orientation.....	7
Unit 1.1.2 Control Systems/Dashboard.....	36
Unit 1.1.3 Pre-and Post-Trip Inspections	40
Unit 1.1.4 Basic Control.....	53
Unit 1.1.5 Shifting/Operating Transmissions.....	61
Unit 1.1.6 Backing and Docking	63
Section 1.2 Safe Operating Procedures	68
Unit 1.2.1 Visual Search.....	68
Unit 1.2.2 Communication	71
Unit 1.2.3 Distracted Driving	74
Unit 1.2.4 Speed Management	78
Unit 1.2.5 Space Management.....	82
Unit 1.2.6 Night Operation.....	85
Unit 1.2.7 Extreme Driving Conditions	87
Section 1.3 Advanced Operating Practices	95
Unit 1.3.1 Hazard Perception	95
Unit 1.3.2 Skid Control/Recovery, Jackknifing, and Other Emergencies	98
Unit 1.3.3 Railroad-Highway Grade Crossing	104
Section 1.4 Vehicle Systems and Reporting Malfunctions	111
Unit 1.4.1 Identification and Diagnosis of Malfunctions.....	111
Unit 1.4.2. Roadside Inspections.....	119
Unit 1.4.3 Maintenance	122
Section 1.5 Non-Driving Activities.....	124
Unit 1.5.1 Handling and Documenting Cargo.....	124
Unit 1.5.2 Environmental Compliance Issues.....	128

Unit 1.5.3 Hours of Service Requirements.....	131
Unit 1.5.4 Fatigue and Wellness Awareness.....	134
Unit 1.5.5 Post-Crash Procedures.....	136
Unit 1.5.6 External Communications.....	139
Unit 1.5.7 Whistleblower/Coercion.....	141
Unit 1.5.8 Trip Planning.....	143
Unit 1.5.9 Drugs/Alcohol.....	145
Unit 1.5.10 Medical Requirements.....	147
Section 2.1 Class B Behind the Wheel Training.....	151
Section 3.1.1 Behind the Wheel – Public Road.....	153
Passenger (P) Endorsement Theory.....	156
Unit C1.1 Post-Crash Procedures.....	156
Unit C1.2 Other Emergency Procedures.....	157
Unit C1.3 Vehicle Orientation.....	161
Unit C1.4 Pre-Trip, En route, and Post-Trip Inspection.....	162
Unit C1.5 Fueling.....	166
Unit C1.6 Idling.....	167
Unit C1.7 Baggage and/or Cargo Management.....	168
Unit C1.8 Passenger Safety Awareness Briefing.....	171
Unit C1.9 Passenger Management.....	172
Unit C1.10 Americans with Disabilities Act (ADA) Compliance.....	173
Unit C1.11 Hours of Service (HOS) Requirements.....	180
Unit C1.12 Safety Belt Safety.....	181
Unit C1.13 Distracted Driving.....	182
Unit C1.14 Railroad (RR) – Highway Grade Crossings and Drawbridges.....	183
Unit C1.15 Weigh Stations.....	185
Unit C1.16 Security and Crime.....	186
Unit C1.17 Roadside Inspections.....	188
Unit C1.18 Penalties and Fines.....	189

Unit C2.1.1 Behind the Wheel – Range and Public Road.....190

Unit D1.1 School Bus Endorsement Training Curriculum Theory Instruction ...192

Unit D1.1 Danger Zones and Use of Mirrors202

Unit D1.2 Loading and Unloading208

Unit D1.3 Vehicle Orientation223

Unit D1.4 Post-Crash Procedures.....226

Unit D1.5 Emergency Exit and Evacuation231

Unit D1.6 Railroad-Highway Grade Crossings.....239

Unit D1.7 Student Management242

Unit D1.8 Special Safety Considerations271

Unit D1.9 Pre- and Post-Trip Inspections D1.9275

Unit D1.10 School Bus Security276

Unit D1.11 Route and Stop Reviews.....282

Section Behind the Wheel – Range and Public Road283

ACRONYMS.....284

This manual was made to meet the curriculum standards for Entry-Level Driver Training (ELDT) for Class B license and for Passenger and School bus endorsements outlined in the [Code of Federal Regulations 49 CFR 380, appendix B/C/D](#). After completing the required trainings, applicants will still need to ensure they meet all their licensing requirements with the Nevada Department of Transportation.

Class B / Endorsement (S) and (P) Theory Instruction Curriculum

There are no required minimum instruction hours for theory training, but the instructor must cover all the topics in curriculum. Training providers must use assessments (in written or electronic format) to determine if trainees are proficient in all units of the theory curriculum. Students must earn a minimum overall score of 80 percent on the theory assessment(s).

ELDT Requirements

Entry-level drivers must receive training and demonstrate proficiency in the following areas:

1. Theory Training
 - a. Lectures, demonstrations, computer based, online learning, etc.
 - b. May use a simulator
 - c. No minimum number of hours; trainees must score at least 80% on assessment
 - d. Training topics include:
 - i. Basic Operation
 - ii. Safe Operating Procedures
 - iii. Advanced Operation Procedures
 - iv. Vehicle Systems and Reporting Malfunctions
 - v. Non-Driving Activities (e.g., Hours of Service)
2. Behind the Wheel Training
 - a. Actual operation of a CMV
 - b. Takes place on a range or public road
 - c. May not use a simulator to meet requirements
 - d. No minimum number of hours, training provider will determine driver's proficiency
 - e. Basic vehicle control skills and mastery of basic maneuvers

Section 1.1 Basic Operation

This section must cover the interaction between driver-trainees and the CMV. Driver-trainees will receive instruction in the Federal Motor Carrier Safety Regulations (FMCSRs) and will be introduced to the basic CMV instruments and controls. This section must also teach driver-trainees how to perform vehicle inspections, control the CMVs under various road and traffic conditions, employ shifting and backing techniques, and couple and uncouple, as applicable. Driver-trainees must familiarize themselves with the basic operating characteristics of a CMV.

Unit 1.1.1 Orientation

This unit must introduce driver-trainees to the commercial motor vehicle driver training curriculum and the components of a commercial motor vehicle. The training providers must teach driver-trainees the safety fundamentals, essential regulatory requirements (i.e., overview of FMCSRs/hazardous materials (HM) regulations), and driver-trainees' responsibilities not directly related to driving. This unit must also cover the ramifications and driver disqualification provisions and fines for non-compliance with parts 380, 382, 383, and 390 through 399 of the FMCSRs. This unit must also include an overview of the applicability of State and local laws relating to the safe operation of the CMV, stopping at weigh stations/scales, hazard awareness of vehicle size and weight limitations, low clearance areas (e.g., CMV height restrictions), and bridge formulas.

Safety Fundamentals

Signs regulate, warn, and inform. The shapes and colors of highway signs have special meanings. This helps you understand the message quickly.

Standard Colors

RED – stop

GREEN – go, direction or guidance

YELLOW or **YELLOW GREEN** – general warning – regulatory, law or rule

ORANGE – road construction or repair warning

BLUE – driver services, such as food and lodging

BROWN – recreation and scenic area information

Standard Shapes

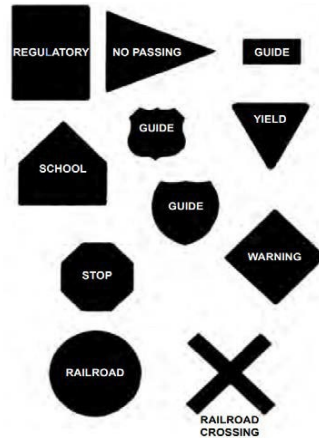

Standard Signs

1. **Stop signs.** You must come to a full stop behind the stop sign at the crosswalk or stop line. If your view of the cross street is blocked, slowly move forward to determine when it is safe to proceed.
 - a. If no stop signs or markings exist, you must slow down and stop, if necessary, at the point nearest the intersection where you have a view of approaching traffic on the through highway.
 - b. You must give right-of-way to pedestrians, bicyclists, and any cross traffic before moving.



2. **Yield signs.** Mean the same as stop signs except you may proceed without coming to a full stop if it is safe to do so. You must:
 - a. Slow down as you come to the intersection
 - b. Give the right of way to pedestrians and through.



3. **Regulatory signs.** Are rectangular and have a white background. They inform you of traffic laws and regulations. You must obey these signs.



4. **Warning signs.** Are yellow, diamond-shaped sign with black letters and symbols. They tell you there are special conditions or hazards ahead.



5. **Railroad crossing signs.** Warns you that you need to slow down and have to stop for a train. The cross buck (X) marks the actual location of the train tracks. School buses have specific requirements for railroad crossings.



6. **Route signs and markers.** Are usually shaped like a shield, but there are different shapes and colors. These signs show U.S., Interstate and State Route Numbers.



Construction and Maintenance Signs

Construction and maintenance signs are used to notify drivers of possible danger in or near work areas. Most signs used in highway and street work areas are diamond-shaped.

Cones, drums, and barricades are used to alert you and to guide you safely through work areas. For night work, they may be equipped with warning lights. When used, you must slow down and follow the direction of the posted signs and any construction flaggers that may be present ([Nevada Driver Handbook](#), pg. 30).



Violations in construction, work, and school zones result in higher fines.

Signals

Signals control traffic at intersections. Combinations of traffic and pedestrian signals, signs, pavement markings and other traffic control devices may be used in some situations.

1. **Red light** means **STOP**. You must come to a complete stop before you reach the intersection. Stop your bus behind the stop line or crosswalk. If there is not a stop line or crosswalk, stop before entering the intersection. Remain stopped until the light turns green. Where not prohibited by signs, a right turn may be made on a red light after coming to a complete stop, when motor and pedestrian traffic is clear, and it is safe to proceed.
2. **Yellow light** means **CAUTION**. A steady yellow light is a warning that the light will be turning red. If you have not entered the intersection, you must stop. If you are already in the intersection, you should continue moving and clear it safely. **DO NOT** speed up to beat the light.
3. **Green light** means **GO**. You may proceed through an intersection in the direction indicated by the signal if the road is clear. Make sure you look right and left for oncoming traffic.
4. **Flashing red light** means that you must come to a **FULL STOP**. You may only go when you have the right-of-way.
5. **Flashing yellow light** means **PROCEED WITH CAUTION**.
6. **Red arrow** means you cannot make the movement shown by the arrow.

7. **Yellow arrow** means the signal is going to change to red and warns you to clear the intersection.
8. **Flashing yellow arrow** means YIELD TO ONCOMING TRAFFIC and PEDESTRIANS.
9. **Green arrow** means you may **GO IN THE DIRECTION SHOWN BY THE ARROW**, but you must yield to pedestrians, bicycles, and traffic already in the intersection ([Nevada Driver's Handbook](#), pg. 30).

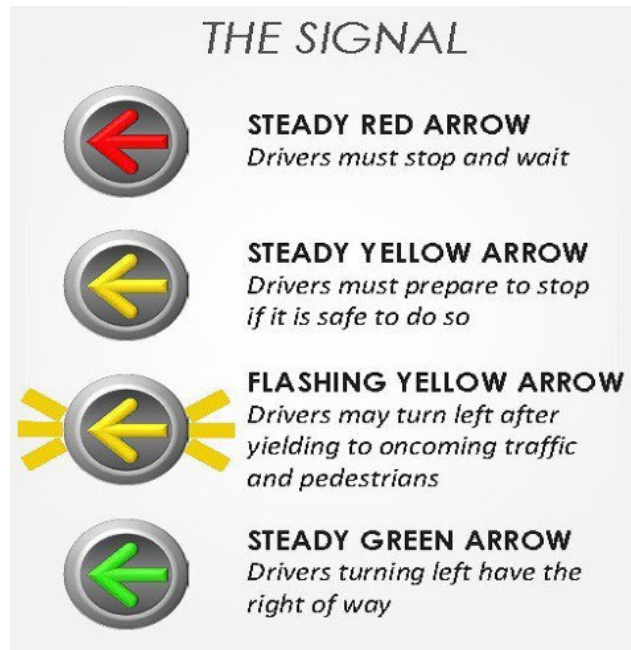

When a traffic control light is not working, you must come to a full stop, yielding to pedestrians, bicyclists and other vehicles that have stopped at the intersection, before proceeding through the intersection.

Highway Markings

Highway markings like signs warn, regulate, and inform. Markings are white and yellow, and each type of line has a special meaning.

1. White Lines

- Dashed white lines are used to mark traffic lanes on roads which have more than one lane moving in the same direction. You should drive within these lanes and not straddle the lines. Passing is permitted when it is safe to do so (See (A) below).
- Solid white lines separate lanes of traffic moving in the same direction and mean that you do not change lanes or pass.

2. Yellow Lines

- Solid or dashed yellow lines mean you may pass when it is safe to do so (See (B) below).

- Solid or double yellow lines means you cannot pass or cross over the line (See (C) below).

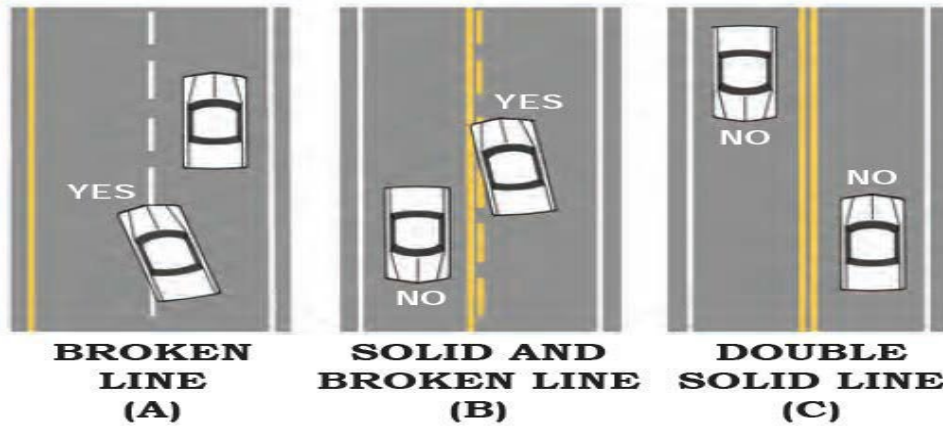

3. **Crosswalk Lines** are marked by solid white lines or various patterns. Always stop your vehicle before the crosswalk. At some intersections, especially in small towns or in residential areas, crosswalks may not be marked. You still must yield to pedestrians in the intersection.
4. **Stop Lines** are the wide white lines painted across a traffic lane where you must stop before you enter the intersection.
5. **Dotted White Lines** may either indicate an extension of a lane line through an intersection or may indicate exit-only lanes on a freeway.
6. **Center Lanes** are marked on each side by solid yellow and broken yellow lines. You may cross these lines only to make a left turn onto or from the highway ([Nevada Driver Handbook](#), pg. 32).
7. Center lanes are not travel lanes and cannot be used for passing. You may not travel more than 200 feet in a center turn lane before making a left-hand turn and you may not travel more than 50 feet in a center lane after making a left-hand turn onto the highway before merging with traffic ([Nevada Revised Statute 484B.223](#)).

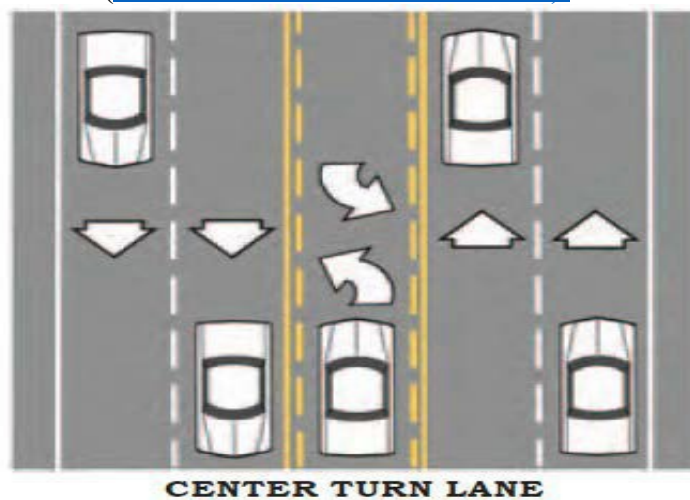

Signaling, Turning, Lane Changes and Passing

Signaling

Using signals to tell others that you are going to change lanes, turn, slow down, stop or park is required by state law. You are required to signal your intentions by continuously signaling not less than: 100 feet in a business or residential area; or 300 feet in any other area ([Nevada Revised Statute 484B.413](#)).

Turning

To make safe and legal turns, you must:

1. Get into the correct lane well in advance;
2. Look ahead, behind and to each side of your vehicle;
3. Be aware of other drivers, pedestrians, and bicyclists;
4. Signal your turn at least 100 feet ahead (about 10 car lengths) on city streets and 300 feet (30 car lengths) on open highways;
5. Watch for and obey traffic signals, signs and pavement markings that direct your movement;
6. Allow time and space to make your turn safely – slow down;
7. Yield the right-of-way to pedestrians, bicyclists another traffic;
8. Steer through the turn and accelerate to the speed of traffic; and
9. Be sure your turn signal is off after you enter the flow of traffic.

When turning right you must:

1. Be in the extreme right-hand travel lane or a lane designated for right turns;
2. If a single lane is provided for turning, you may only enter the lane if you are making a right turn, and may not travel through an intersection while driving in the right-turn lane;
3. Turn into the right-hand lane of the roadway you are entering, or the lane designated for the turn; and
4. If you need to change lanes, signal, and proceed carefully to the next lane when you are well away from the intersection.

When turning left you must:

1. Keep your wheels pointed straight ahead until you begin to actually complete the turn;
2. On a two-way road, use the lane just to the right of the center line, and complete the turn into the traffic lane closest to you going in your intended direction; and
3. Do not attempt to change lanes until you can do so safely.

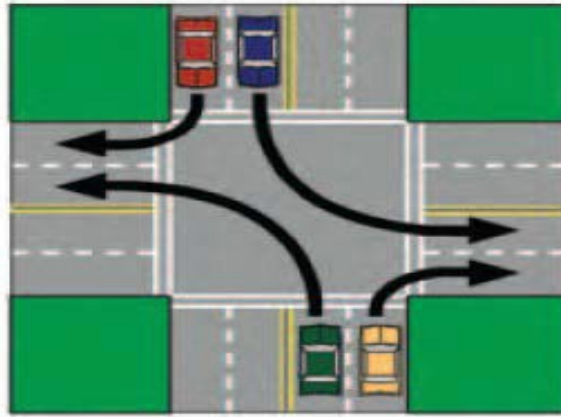

Lane changes

When you want to change lanes, you must:

1. Use your mirrors, doing a 5-count mirrors to check for traffic;
2. Signal 100 feet (10 car lengths) on city streets, 300 feet (30 car lengths) on highways or freeways before changing lanes;
3. Check blind spots by looking over your shoulder and change lanes when traffic is clear; and
4. Do not change lanes in an intersection ([Nevada Driver Handbook](#), pg. 46).

Changing lanes while traveling through an intersection is prohibited!

Passing

Safe passing rules depend on the type of street or highway you are using. School buses are big and heavy and passing should only occur when **ABSOLUTELY** necessary.

1. You should never exceed the speed limit to pass another vehicle and you can never use the shoulder of the road to pass.
2. On two-lane roads where traffic moves in opposite directions, you may pass on the left only when:
 - a. You can see clearly ahead and there is no immediate oncoming traffic;
 - b. There is a broken yellow line on the highway or when the broken yellow line is in your lane; and
 - c. It is safe to do so.

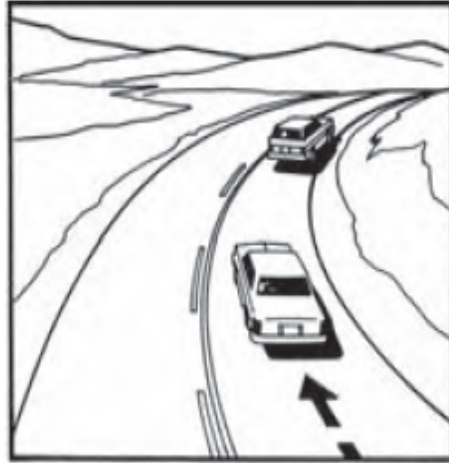

3. When passing on a two-lane road, turn your left signal light on 100 feet ahead in business or residential areas or 300 feet ahead in other areas. After you have passed, pull back into your lane when you can see the vehicle you passed in your rear-view mirror.
4. You must **NOT PASS** on a two-lane road:
 - a. When coming to a curve or the top of a hill where you cannot see far enough ahead to be sure it is safe;
 - b. Within 100 feet of a street crossing;
 - c. Within 100 feet of a railroad crossing;
 - d. Where there is a double solid yellow line on the highway; and
 - e. Where signs prohibit passing.

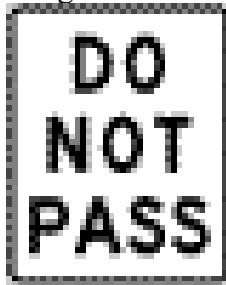

5. When **another vehicle** comes up behind yours and signals to pass, move to the right without leaving your travel lane and let it pass. Never speed up when another vehicle is passing you.
6. On **multi-lane streets** and **highways**, you may pass vehicles traveling in the same direction on the left if there are no signs or highway markings that indicated passing is not allowed and it can be done safely. Remember to signal, do a 5-count mirror check for traffic and look over your shoulder before moving out of your lane. Never pass to the left of a driver who is making or signaling a left turn.
7. You may **pass on the right** if the street or highway is clearly marked for two or more lanes of traffic moving in the same direction you are, but only when passing is safe. Passing on the right is very dangerous if the other driver does not see you and decides to

change lanes. Remember to signal, do a 5-count mirror check and check your blind spots before you change lanes.

8. **Passing bicyclists.** When passing a cyclist, a motorist must:
- Move into the lane to the left if more than one lane for traffic in the same direction exists and doing so is reasonably safe;
 - If an adjacent lane does not exist, pass to the left of the bicycle at a safe distance, which must be at least three feet, and you may not move back to the right until the vehicle is safely clear of the bicycle;



- Passing or traveling in a marked bicycle lane is prohibited ([Nevada Revised Statute 4848B.270](#)); and
- School bus drivers may cross a bike lane to enter the emergency/turn lane for the purposes of loading and unloading students ([Nevada Driver Handbook](#), pg. 48).



School Areas and School Zones



Speed Limit in School Zones

- In school zones the speed limit is either 15 or 25 mph. These speed limits are in effect on school days from half an hour before school begins to half an hour after school ends,

unless otherwise posted.

- Some areas may use flashing yellow lights to tell you when the speed limit is in effect. Signs and signals clearly show these speed limits and designate the hours when the speed limit is in effect or that the speed limit is in effect when children are present ([Nevada Driver Handbook](#), (pg. 33) and [Nevada Revised Statute 484B.636](#)).



Safety Zones

- Safety zones are designated areas which are used exclusively for pedestrians. You are prohibited from driving through or within a safety zone ([Nevada Revised Statute 484B.110](#)).
- School zones are considered safety zones. There are additional penalties for tickets received in designated safety zones ([Nevada Revised Statute 484B.135](#)).

Passing and U-Turns in School Zones

1. Nevada state law prohibits vehicles from overtaking and passing another vehicle that has stopped in a designated school zone. This includes school buses passing other school buses that have stopped to load or unload students.
2. You are also not allowed to make a U-turn in a designated school zone or school crossing zone ([Nevada Revised Statute 484B.363](#)).
3. It is illegal for school bus drivers to pass other school buses that have stopped, with red lights flashing and stop arms activated.



Commercial Driver Licensing (CDL) Requirements

When a CDL is Required

You must have a CDL to operate:

- Any vehicle with a gross vehicle weight rating (GVWR) of 26,001 pounds or more (Class A, B or C).
- Any vehicle designed to transport 16 or more passengers, including the driver (Class C) ([Nevada Commercial Driver License Manual](#), pg. 1-1).

When a CDL Is Not Required

A CDL is not required for a Type A school bus that is designed to transport 16 passengers or less, including the driver ([Federal Motor Carrier Safety Regulation, Classes of License and Commercial Learner's Permits](#)).

CDL Endorsements

The following are types of CDL Endorsements. As a school bus driver, you will be required to have Passenger (P) and School Bus (S) endorsements on your CDL.

1. **T-** Doubles/Triple trailers
2. **P-** Passenger: to receive a Passenger endorsement, you must satisfy the following additional knowledge and skills test requirements outlined in [Federal Motor Carrier Safety Regulation 383.117, Requirements for Passenger Endorsement](#).
 - a. Knowledge Test for a Passenger (P) Endorsement:
 - i. Proper procedures for loading and unloading passengers;
 - ii. Proper use of emergency exits, including push-out windows;
 - iii. Proper responses to such emergency situations as fires and unruly passengers;
 - iv. Proper procedures at railroad-highway grade crossings and drawbridges; and
 - v. Proper braking procedures.
 - vi. Operating practices and procedures not otherwise specified.
 - b. Skills test. To obtain a passenger endorsement applicable to a specific vehicle class, an applicant must take his/her skills test in a passenger vehicle satisfying the requirements of that vehicle group as defined in [49 CFR 383.91 \(a\) Commercial vehicle motor groups](#).
3. **N-** Tank Vehicle
4. **H-** Hazardous Material
5. **X-** Hazardous Materials and Tankers
6. **S-** School Bus: to receive a School Bus endorsement, you must satisfy the following additional knowledge and skills test requirements outlined in [Federal Motor Carrier Safety Regulation 383.123, Requirements for School Bus Endorsement](#).
 - a. *Qualify for passenger vehicle endorsement.* Pass the knowledge and skills test for obtaining a passenger vehicle endorsement.

- b. Knowledge test. Must have knowledge covering the following topics:
 - i. Loading and unloading children, including the safe operation of stop signal devices, external mirror systems, flashing lights and other warning and passenger safety devices required for school buses by State or Federal law or regulation;
 - ii. Emergency exits and procedures for safely evacuating passengers in an emergency;
 - iii. State and Federal laws and regulations related to safely traversing railroad-highway grade crossings; and
 - iv. Operating practices and procedures not otherwise specified.
- c. Skills test Must take a driving skills test in a school bus of the same vehicle group ([49 CFR§ 383.91](#)) as the school bus applicant will drive.

CDL Restrictions

Commercial Driver's Licenses, just like standard licenses, can be issued with restrictions. The most common restrictions on a CDL are:

1. **B- Corrective Lenses:** This restriction is placed on the driver's license of a person who meets the minimum levels of acceptable vision set forth in [NAC 483.341](#) only with the aid of corrective lenses.
2. **E- No Manual Transmission:** This restriction is placed on a commercial vehicle if the applicant performs the skills test in a vehicle equipped with an automatic transmission. This restriction can also be placed on a noncommercial class A or B license.
3. **JX- No Air Brakes:** This restriction is placed on the driver's license of a person who does not pass a knowledge test or a driving skills test in a non-commercial motor vehicle which is equipped with air brakes.
4. **K- CMV Intrastate Only:** May operate a CMV on an intrastate basis only. This restriction is placed on the commercial driver's license of a person who does not meet the requirements set forth in [49 CFR §§ 391.41 to 391.49](#), inclusive, who is under 21 years of age, or who has self-certified as driving intrastate excepted or intrastate non-excepted.

CDL Required Testing and Endorsements

[Nevada Commercial Driver License Manual](#), (pg. 1-5) You will be required to complete the following tests:

1. Vision Testing
2. CDL Knowledge Tests:

- a. General knowledge test;
 - b. Passenger Transport test (P);
 - c. School bus test (S); and
 - d. Air-brake test (if vehicle has airbrakes).
3. CDL Skills Exam:
- a. Vehicle inspection;
 - b. Basic vehicle control; and
 - c. On-road driving test.

Entry-Level Driving Training Requirements (ELDT)

1. ELDT requirements as outlined in [Federal Motor Carrier Safety Regulation 380.609, General entry-level driver training requirements](#) apply to:
 - a. Obtain a Class A or Class B CDL for the first time;
 - b. Upgrade an existing Class B CDL to a Class A CDL; or
 - c. Obtain a school bus (S), passenger (P), or hazardous materials (H) endorsement for the first time.
2. In order to provide training to an entry-level driver, your district or school will need to meet all requirements as a training provider and be listed on the [Federal Motor Carrier Safety Administration's Entry-Level Driver Training \(ELDT\) Registry](#).
 - a. You must follow a curriculum that meets the applicable criteria of [§380.101-§380.513](#).
 - b. Utilize facilities that meet the criteria set forth in [§380.709](#).
 - c. Utilize vehicles that meet the criteria set forth in [§380.711](#).
 - d. Utilize driver training instructors that meet the criteria set forth in [§380.713](#).
 - e. Be licensed, certified, registered, or authorized to provide training in accordance with the applicable Nevada law and regulations.
 - f. Allow FMCSA or its authorized representative to audit or investigate the training provider's operations to ensure that the provider meets the criteria.
 - g. Electronically transmit an Entry-Level Driver Training Provider Registration Form through the Training Provider Registry (TPR) Web site maintained by FMCSA, which attests that the training provider meets all the applicable requirements.
 - i. If the training provider has more than one campus or training location, the provider must electronically transmit a registration form for each campus or training location.
 - ii. When a provider meets the above requirements, FMCSA will issue the provider a unique TPR number and, as applicable, add the provider's name

and/or contact information to the TPR Web site.

- iii. Registration must be renewed every two years and training providers must report any changes to key information within 30 days of the change.
3. Once a driver-trainee completes training administered by a provider listed on the Training Provider Registry, the provider must, by midnight of the second business day after the driver- trainee completes training, electronically transmit training certification information through the Trainer Provider Registry ([Federal Motor Carrier Safety Administration 380.717, Training Certification](#)).

Definitions

Behind-the-wheel (BTW) instructor means an individual who provides BTW training involving the actual operation of a CMV by an entry-level driver on a range or a public road and meets one of these qualifications:

1. Holds a CDL of the same (or higher) class and with all endorsements necessary to operate the CMV for which training is to be provided and has at least 2 years of experience driving a CMV requiring a CDL of the same or higher class and/or the same endorsement and meets all applicable State qualification requirements for CMV instructors; or
2. Holds a CDL of the same (or higher) class and with all endorsements necessary to operate the CMV for which training is to be provided and has at least 2 years of experience as a BTW CMV instructor and meets all applicable State qualification requirements for CMV instructors.

Noted exception: A BTW instructor who provides training solely on a range which is not a public road is not required to hold a CDL of the same (or higher) class and with all endorsements necessary to operate the CMV for which training is to be provided, as long as the instructor previously held a CDL of the same (or higher) class and with all endorsements necessary to operate the CMV for which training is to be provided, and complies with the other requirements set forth in paragraphs (1) or (2) of this definition.

Behind-the-wheel (BTW) public road training means training provided by a BTW instructor when an entry-level driver has actual control of the power unit during a driving lesson conducted on a public road. BTW public road training does not include the time that an entry-level driver spends observing the operation of a CMV when he or she is not in control of the vehicle.

Behind-the-wheel (BTW) range TRAINING means training provided by a BTW instructor when an entry-level driver has actual control of the power unit during a driving lesson conducted on a range. BTW range training does not include time an entry-level driver spends observing the operation of a CMV when he or she is not in control of the vehicle.

Entry-level driver means an individual who must complete the CDL skills test requirements under [§ 383.71 of this subchapter](#) prior to receiving a CDL for the first time, upgrading to a Class A or Class B CDL, or obtaining a hazardous materials, passenger, or school bus endorsement for the first time. This definition does not include individuals for whom States waive the CDL skills test under [§ 383.77](#) or individuals seeking to remove a restriction in accordance with [§](#)

[383.135\(b\)\(7\) of this subchapter.](#)

Entry-level driver training means training an entry-level driver receives from an entity listed on FMCSA's Training Provider Registry prior to:

1. Taking the CDL skills test required to receive the Class A or Class B CDL for the first time;
2. Taking the CDL skills test required to upgrade to a Class A or Class B CDL; or
3. Taking the CDL skills test required to obtain a passenger and/or school bus endorsement for the first time or the CDL knowledge test required to obtain a hazardous materials endorsement for the first time.

Range means an area that must be free of obstructions, enables the driver to maneuver safely and free from interference from other vehicles and hazards, and has adequate sight lines.

Theory instruction means knowledge instruction on the operation of a CMV and related matters provided by a theory instructor through lectures, demonstrations, audio-visual presentations, computer-based instruction, driving simulation devices, online training, or similar means.

Theory instructor means an individual who provides knowledge instruction on the operation of a CMV and meets one of these qualifications:

1. Holds a CDL of the same (or higher) class and with all endorsements necessary to operate the CMV for which training is to be provided and has at least 2 years of experience driving a CMV requiring a CDL of the same (or higher) class and/or the same endorsement and meets all applicable State qualification requirements for CMV instructors; or
2. Holds a CDL of the same (or higher) class and with all endorsements necessary to operate the CMV for which training is to be provided and has at least 2 years of experience as a BTW CMV instructor and meets all applicable State qualification requirements for CMV instructors.

Noted Exemption: An instructor is not required to hold a CDL of the same (or higher) class and with all endorsements necessary to operate the CMV for which training is to be provided, if the instructor previously held a CDL of the same (or higher) class and complies with the other requirements set forth in paragraphs (1) or (2) of this definition. Training providers offering online content exclusively are not required to meet State qualification requirements for theory instructors.

Training provider means an entity that is listed on the FMCSA Training Provider Registry. Training providers include, but are not limited to, training schools, educational institutions, rural electric cooperatives, motor carriers, State/local governments, school districts, joint labor management programs, owner-operators, and individuals.

Instructor Disqualification If an instructor's CDL has been cancelled, suspended, or revoked due to any of the disqualifying offenses identified in [§ 383.51 of this subchapter](#), the instructor is prohibited from engaging in BTW or theory instruction for 2 years following the date his or her

CDL is reinstated.

Commercial Learners Permit (CLP)

A CLP is issued for a 180-day period for entry-level driver training on public roads or highways. Applicants must be at least 21 years old and pass the vision and all required written examinations ([Nevada Commercial Driver License Manual](#), (pg. ii) [Nevada Administrative Code 386.530](#)).

1. Drivers with a CLP must be accompanied at all times by a driver who:
 - a. Is at least 25 years of age;
 - b. Holds a CDL for the proper class and endorsements; and
 - c. Is seated next to the driver. In school buses, the instructor must be seated in the first seat to the right of the driver.
2. School bus drivers that hold a current Commercial Driver License with required endorsements must:
 - a. Receive training in the operation of a school bus from a state certified school bus driver trainer.
 - b. Training cannot be provided behind the wheel while driving the school bus while it is occupied by pupils.

Renewing Your CDL

It is your responsibility to renew your CDL prior to the expiration date ([Nevada Official Driver Handbook](#), pg. 19).

You are required to notify the DMV of any address or name changes within 30 days.
[Nevada Driver Handbook](#), pg.19

Border State Employees

A border state employee means a person whose legal residence is not in this State, who resides outside of the State of Nevada and commutes on a daily basis into the State of Nevada for the solely for the purposes of employment at a place of employment which is less than 35 air miles from the state border ([Nevada Revised Statute 482.012](#)).

Which license and endorsement?

Determining Class of CDL Required

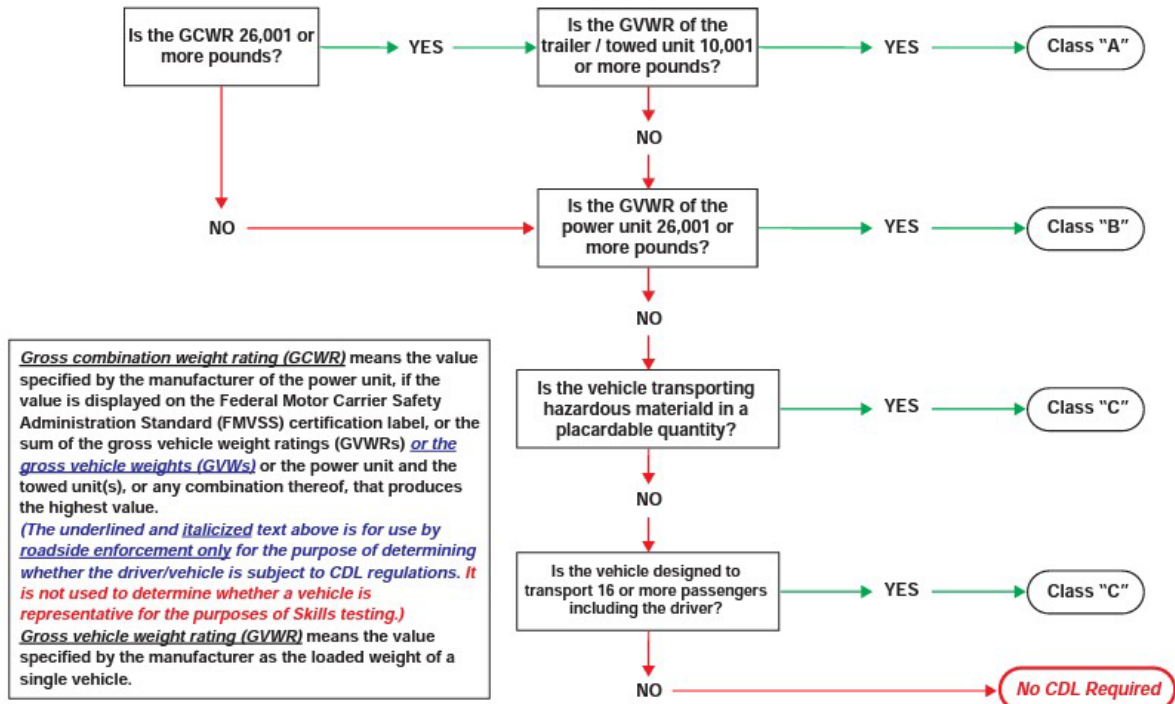

CDL Examiner's Manual - 2005 CDL Test System
Version: August 2017

Revised April 23, 2014

Nevada DMV (2017) "Determining class of CDL required" [flowchart] retrieved from <https://dmv.nv.gov/pdf/forms/cdl-flowchart-class.pdf>

As a school bus driver, you will be required to have **Passenger (P)** and **School Bus (S)** endorsements on your CDL.

S - School Bus to receive a School Bus endorsement, you must satisfy the following additional knowledge and skills test requirements:

1. Loading and unloading children, including the safe operation of stop signal devices, external mirror systems, flashing lights and other warning and passenger safety devices required for school buses.
2. Emergency exits and procedures for safely evacuating passengers in an emergency.
3. Laws regarding railroad-highway grade crossings.
4. To learn more about each unit in the curriculum, see the [Code of Federal Regulations \(49 CFR 380, Appendix D\)](#).

P - Passenger endorsement to receive a passenger endorsement, you must satisfy both of the following additional knowledge and skills test requirements. To learn more about each unit in the curriculum, see the [Code of Federal Regulations \(49 CFR 380, Appendix C\)](#).

Essential Regulatory Requirements

Commercial driver's licensing, and required trainings are regulated by both **interstate** and **intrastate** regulations.

Interstate transportation includes anything that crosses state lines. Interstate commerce is regulated by Federal Motor Carrier Safety Administration (FMCSA) within the United States Department of Transportation (DOT). The primary mission of the Federal Motor Carrier Safety Administration (FMCSA) is to reduce crashes, injuries and fatalities involving large trucks and buses.

The FMCSA was established as a separate administration within the U.S. Department of Transportation (DOT) on January 1, 2000, pursuant to the Motor Carrier Safety Improvement Act of 1999. FMCSA is headquartered in Washington, DC and employs more than 1,000 people in all 50 States and the District of Columbia, all dedicated to improving the safety of commercial motor vehicles (CMV) and saving lives. See [FMCSA website](#) for more information.

Intrastate transportation includes driving only within one state's borders. Intrastate regulation is regulated by state, and local laws.

Major regulations that each driver should know include [CFR 380, 382, 383, 390-399](#). These laws are applicable to all employers, employees, and commercial motor vehicles that transport property or passengers in interstate commerce.

Part 380 - Subpart F - Entry-Level Driver Training Requirements On and After February 7, 2022

1. ELDT requirements apply to:
 - a. An individual who applies, for the first time, for a Class A or Class B CDL, or who upgrade to a class A or B CDL; or
 - b. An individual seeking to obtain a passenger (P) and/or school bus endorsement for the first time ([Federal Motor Carrier Safety Regulation 380.609, General entry-level driver training requirements](#)).
2. In order to provide training to an entry-level driver, your district or school will need to meet all requirements as a training provider and be listed on the [Federal Motor Carrier Safety Administration's Entry-Level Driver Training \(ELDT\) Registry](#).
 - a. You must follow a curriculum that meets the applicable criteria [of §380.101-§380.513](#).
 - b. Utilize facilities that meet the criteria set forth in [§380.709](#).
 - c. Utilize vehicles that meet the criteria set forth in [§380.711](#).
 - d. Utilize driver training instructors that meet the criteria set forth in [§380.713](#).
 - e. Be licensed, certified, registered, or authorized to provide training in accordance with the applicable Nevada law and regulations.

- f. Allow FMCSA or its authorized representative to audit or investigate the training provider's operations to ensure that the provider meets the criteria.
- g. Electronically transmit an Entry-Level Driver Training Provider Registration Form through the Training Provider Registry (TPR) Web site maintained by FMCSA, which attests that the training provider meets all the applicable requirements.
 - i. If the training provider has more than one campus or training location, the provider must electronically transmit a registration form for each campus or training location.
 - ii. When a provider meets the above requirements, FMCSA will issue the provider a unique TPR number and, as applicable, add the provider's name and/or contact information to the TPR website.
 - iii. Registration must be renewed every two years and training providers must report any changes to key information within 30 days of the change.
 - iv. Once a driver-trainee completes training administered by a provider listed on the Training Provider Registry, the provider must, by midnight of the second business day after the driver- trainee completes training, electronically transmit training certification information through the Trainer Provider Registry ([Federal Motor Carrier Safety Administration 380.717, Training Certification](#)).

Part 382 Controlled Substances and Alcohol use and testing.

1. The purpose of this part is to establish programs designed to help prevent accidents and injuries resulting from the misuse of alcohol or use of controlled substances by drivers of commercial motor vehicles.
2. Required Testing The United State Department of Transportation has published "[What Employees Need to Know About DOT Alcohol & Drug Testing](#)" as a reference for testing procedures and frequently asked questions about [CFR 382](#).
3. All school bus drivers must submit to any of the following testing:
 - a. **Pre-Employment.** Prior to the first time driving, a driver shall undergo testing for controlled substances and the employer must receive a negative test result.
 - b. **Post-Accident.** An employer shall test for controlled substances and alcohol as soon as practical following a crash.
 - c. **Random Testing.** Every driver shall submit to random controlled substance and alcohol testing.
 - d. **Reasonable Suspicion.** Your employer shall require a driver to submit to an alcohol test when the employer has reasonable suspicion to believe the driver is under the influence.
4. Drug and Alcohol Clearinghouse - effective January, 6, 2020, the [Federal Motor Carrier Safety Regulation, Drug & Alcohol Clearinghouse](#) will require the following:

- a. FMCSA regulation employers to report to the Clearinghouse information related to violations of the drug and alcohol regulations under [Federal Motor Carrier Safety Regulation 382.701, Drug and Alcohol Clearinghouse](#).
- b. Employers will be required to query the Clearinghouse for current and prospective employees' drug and alcohol violations before permitting those employees to operating a DMV on public roads.
- c. Employers will be required to annually query the Clearinghouse for each driver they currently employ.

Part 383 Commercial Driver's License Standards; Requirements and penalties. The purpose of this part is to help reduce or prevent truck and bus accidents, fatalities, and injuries by requiring drivers to have a single commercial motor vehicle driver's license and by disqualifying drivers who operate commercial motor vehicles in an unsafe manner.

A CLP is issued for a 180-day period for entry-level driver training on public roads or highways. Applicants must be at least 21 years old and pass the vision and all required written examinations ([Nevada Commercial Driver License Manual](#), (pg. iii), [Nevada Administrative Code 386.530](#)).

1. Drivers with a CLP must be accompanied at all times by a driver who:
 - a. Is at least 25 years of age;
 - b. Holds a CDL for the proper class and endorsements; and
 - c. Is seated next to the driver. In school buses, the instructor must be seated in the first seat to the right of the driver.

Disqualifications

You may not drive a commercial vehicle if you are disqualified for any reason.

You can be put out-of-service for 24 hours if you have any detectable amount of alcohol under 0.04%. A detailed list of Driver Out-of-Service conditions are on page 29 of this manual.

You can be disqualified due to violations in your personal vehicle. If your license to operate your personal vehicle is revoked, cancelled, or suspended you may *not* obtain a "hardship" license to operate a CMV.

It is illegal to operate a CMV if your blood alcohol concentration (BAC) is .04% or more. If you operate a CMV, you shall be deemed to have given your consent to alcohol testing.

You can be disqualified for refusal to undergo such testing as is required in the enforcement of alcohol use.

Driving a CMV while under the influence of a controlled substance. Leaving the scene of an accident involving a CMV.

A **Serious Traffic Violation** is defined as excessive speeding (15 mph or more above the posted limit), reckless driving, improper or erratic lane changes, following a vehicle too closely, traffic offenses committed in a CMV in connection with fatal traffic accidents, driving a CMV without obtaining a CDL or having a CDL in the driver's possession, and driving a CMV without the proper class of CDL and/or endorsements ([Nevada Commercial Driver's License Manual](#), p.1-8).

A Railroad-Highway Grade Violation is a violation of a federal, state, or local law or regulation pertaining to one of the following six offenses at a railroad-highway grade crossing:

1. For drivers who are not required to always stop, failing to stop before reaching the crossing if the tracks are not clear.
2. For drivers who are not required to always stop, failing to slow down and check that the tracks are clear of an approaching train.
3. For drivers who are always required to stop, failing to stop before driving onto the crossing.
4. For all drivers failing to have sufficient space to drive completely through the crossing without stopping.
5. For all drivers failing to obey a traffic control device or the directions of an enforcement official at the crossing.
6. For all drivers failing to negotiate a crossing because of insufficient undercarriage clearance.

Variable Disqualifications

If your privilege to operate your *personal vehicle* is revoked, cancelled, or suspended due to violations of traffic control laws (other than parking violations) you will also lose your CDL driving privileges for that same period.

At Least 60-Day Disqualifications

1. For two serious traffic violations within a three-year period involving a CMV.
2. For the first Railroad-Highway Grade Violation.

At Least 90-Day Disqualifications

1. For the first violation of an out-of-service order.

At Least 120-Day Disqualifications

1. For three or more serious traffic violations within a three-year period involving a CMV.
2. For the second Railroad-Highway Grade Violation in a three-year period.

At Least 1-Year Disqualifications

1. For the first offense of:
 - a. Driving a CMV if your blood alcohol concentration is 0.04% or higher.

- b. Driving a CMV under the influence of alcohol.
- c. Refusing to undergo blood alcohol testing.
- d. Driving a CMV while under the influence of a controlled substance.
- e. Leaving the scene of an accident involving a CMV.
- f. Committing a felony involving the use of a CMV.
- g. Driving a CMV when the CDL is suspended.
- h. Causing a fatality through negligent operation of a CMV.

You are required to notify your employer immediately if you are charged with driving under the influence of alcohol or drugs.

- 2. If you have committed two violations of an out-of-service order in a ten-year period.
- 3. For the third Railroad-Highway Grade Violation in a three-year period.
- 4. If your privilege to operate your *personal vehicle* is revoked, cancelled, or suspended due to alcohol, controlled substance, or felony violations.

At Least 3-Year Disqualifications

- 1. If you have committed three or more out-of-service violations in a ten-year period.

Lifetime Disqualifications

- 1. If you use a CMV to commit a felony involving controlled substances.
- 2. For the second offense of:
 - a. Driving a CMV if your blood alcohol concentration is 0.04% or higher.
 - b. Driving a CMV under the influence of alcohol.
 - c. Refusing to undergo blood alcohol testing.
 - d. Driving a CMV while under the influence of a controlled substance.
 - e. Leaving the scene of an accident involving a CMV.
 - f. Committing a felony involving the use of a CMV.
 - g. Driving a CMV when the CDL is suspended.
 - h. Causing a fatality through negligent operation of a CMV.
- 3. If you are convicted of a second violation in your *personal vehicle* due to alcohol, controlled substance, or felony violations.

Part 391.11, General Qualifications of Drivers

You are considered qualified to drive a CMV if you are:

1. At least 21 years old;
2. Can read and speak the English language sufficiently to converse with the general public, understand highway traffic signs and signals in the English language, respond to official inquiries, and make entries on reports and records;
3. Can, by reason of experience, training, or both, safely operate the CMV you drive;
4. Physically qualified to drive a CMV. You will be required to provide a current Medical Examiner's Certificate;
5. Have a current, valid CMV license issued by only on estate;
6. Have provided your employer with a list of all violations;
7. Are not disqualified to drive a CMV under the rules of [§391.15](#); and
8. Has successfully completed a driver's road test or equivalent test deemed acceptable by your employer.

Other CDL Rules

1. You cannot have more than one license.
2. You must notify your employer within 30 days of conviction for any traffic violation (except parking). This is true no matter what type of vehicle you were driving.
3. You must notify DMV within 30 days if you are convicted in any other jurisdiction of any traffic violation (except parking). This is true no matter what type of vehicle you were driving.
4. You must notify your employer within two business days if your license is suspended, revoked, or cancelled, or if you are disqualified from driving.
5. You must give your employer information on all driving jobs you have held for the past 10 years.
6. You cannot drive a CMV without a current, valid CDL with all required endorsements.
7. All states are connected to one computerized system to share information about CDL drivers.
8. You are not allowed to hold a mobile telephone to conduct a voice communication or dial a mobile telephone by pressing more than a single button when driving.
9. You will be disqualified for conducting voice communication or dialing a mobile telephone, sending or reading text messages while operating a CMV.
10. You must be properly restrained by a safety belt at all times while operating a CMV ([Nevada Commercial Driver License Manual](#), pg. 1-9).
11. At least every 12 months, your employer will require you to obtain or consent to obtain your driving record from DMV ([Federal Motor Carrier Safety Regulation 391.25, Annual Inquiry and Review of Driving Record](#)).

Driving means operating a CMV, with the motor running, including while temporarily stationary because of traffic, a traffic control device, or other momentary delays.

[Federal Motor Carrier Safety Regulation 392.80, Prohibition Against Texting,](#)

Other Federal Regulations

Below is a list of Federal Motor Carrier Safety Administration rules, and regulations that apply to Commercial Drivers. Not all will apply to school bus drivers. Relevant regulations will be referenced throughout this manual. This list is for your own reference, and knowledge.

Public schools transporting public school students are exempt from §390-§396 (except where required by Nevada law). Private schools transporting private school students between home and school are also exempt. Private schools transporting students for extracurricular activities are **not** exempt.

Private schools which need additional information about conforming to these additional requirements for extracurricular transportation can reach out to the Nevada Department of Education for assistance.

1. [Part 40](#)- Drug and Alcohol Regulations: Federal regulations regarding drug and alcohol testing procedures and responsibilities.
2. [Part 380](#)- Special Training Requirements: Special training requirements for drivers of Longer Combination Vehicles (LCVs) and Entry Level Driver Training for CDL drivers.
3. [Part 381](#)- Waivers, Exemptions, and Pilot Programs
4. [Part 382](#)- Controlled Substances, Alcohol Use, and Testing
5. [Part 383](#)- CDL Standards, Requirements, and Penalties
6. [Part 390](#)- FMSCA General Regulations
7. [Part 391](#)- Qualifications of drivers and longer combination vehicles (LCV) driver instructors
8. [Part 392](#)- Driving Commercial Motor Vehicles
9. [Part 393](#)- Part and Accessories Necessary for Safe Operation
10. [Part 395](#)- Hours of Service Of Drivers (State and Local Laws)
11. [Part 396](#)- Inspection, Repair, and Maintenance
12. [Part 397](#)- Transporting Hazardous Materials; Driving, and Parking Rules
13. [Part 398](#)- Transporting Migrant Workers
14. [Part 399](#)- Employee Safety and Health Standards

Hazardous Materials

Hazardous Materials Class			
Class	Division	Name of Class or Division	Examples
1	1.1	Mass Explosion	Dynamite Flares Display Fireworks Ammunition Blasting Agents Explosive Devices
	1.2	Projection Hazard	
	1.3	Fire Hazard	
	1.4	Minor Explosion	
	1.5	Very Insensitive	
	1.6	Extremely Insensitive	
2	2.1	Flammable Gases	Propane Helium
	2.2	Non-Flammable Gases	
	2.3	Poisonous/Toxic Gases	Fluorine, Compressed
3	-	Flammable Liquids	Gasoline
4	4.1	Flammable Solids	Ammonium Picrate, Wetted White Phosphorus Sodium
	4.2	Spontaneously Combustible	
	4.3	Dangerous When Wet	
5	5.1	Oxidizers	Ammonium Nitrate Methyl Ethyl Ketone Peroxide
	5.2	Organic Peroxides	
6	6.1	Poison (Toxic Material)	Potassium Cyanide
	6.2	Infectious Substances	Anthrax Virus
7	-	Radioactive	Uranium
8	-	Corrosives	Battery Fluid
9	-	Miscellaneous Hazardous Materials	Polychlorinated Biphenyls (PCB)
e	-	ORM-D (Other Regulated Material-Domestic)	Food Flavorings, Medicines
-	-	Combustible Liquids	Fuel Oil

Nevada DMV (2012) "CDL Hazard Materials handbook[PDF] retrieved from <https://dmv.nv.gov/pdf/forms/dlbookhazmat.pdf>

Hazardous materials are products that pose a risk to health, safety, and property during transportation. For details see [DMV HazMat Handbook](#). The term often is shortened to HAZMAT, which you may see on road signs, or to HM in government regulations. Hazardous materials include explosives, various types of gas, solids, flammable and combustible liquid, and other materials. Because of the risks involved and the potential consequences these risks impose, all levels of government regulate the handling of hazardous materials. The Hazardous Materials Regulations (HMR) is found in parts 100 - 185 of title 49 of the Code of Federal Regulations. The common reference for these regulations is [49 CFR 100 - 185](#).

The regulations require vehicles transporting certain types or quantities of hazardous materials to display diamond-shaped, square on point, warning signs called placards.



Nevada DMV (2012)"CDL Hazard Materials handbook[PDF] retrieved from <https://dmv.nv.gov/pdf/forms/dlbookhazmat.pdf>

A material's hazard class reflects the risks associated with it. There are nine different hazard classes.

Placards are used to warn others of hazardous materials. Placards are signs put on the outside of a vehicle which identify the hazard class of the cargo. A placarded vehicle must have at least four identical placards. They are put on the front, rear, and both sides of the vehicle.

Non-driving responsibilities

Drivers are responsible for vehicle inspections. Regardless of who is loading the cargo the driver is responsible for inspecting the cargo, recognizing overloads, poorly balanced weight, knowing the cargo is secured, knowing that the cargo does not inhibit vision to the front or sides, and that the cargo does not restrict access to emergency equipment.

Vehicles with specific securement requirements can include: lumber, pipes, auto haulers, containers, and construction materials. Tie downs can include ropes, chains and ratchet straps.

Drivers if applicable and practical must inspect the load-securing devices within the first 50 miles of a trip and re-examine whenever a change to duty status occurs or after 3 hours or 150 miles whichever occurs first.

The minimum working load limit for tie downs to secure cargo is at least $\frac{1}{2}$ the weight of the cargo and there should be at least one tie down for every 10 feet of cargo and there should always be at least two tie downs no matter how small the cargo is.

After-trip inspection and reporting.

The driver may have to make a written report each day on the condition of the vehicle(s) they drove. Report anything affecting safety or possibly leading to mechanical breakdown.

Roadside Inspections

School buses are exempt from roadside inspections and weigh stations.

Other CMVs are required to stop at weigh stations to ensure trucks are within weight compliance with state regulations. In the state of Nevada under [NRS 484D.635](#), the maximum weight of a

vehicle on any axle or per tire should not exceed 20,000 pounds.

Vehicle Size and Hazard Awareness

Nevada laws regarding the required dimensions of vehicles can be found in [NRS 484D.600-740](#).

Maximum Height

In Nevada, the maximum height of a vehicle cannot exceed 14 feet from the surface on which the vehicle stands, even with a full load.

Maximum Length

The maximum length of a bus may not exceed 45 feet.

Maximum Width

The maximum width of a bus is 102 inches, excluding mirrors, lights, or other safety devices.

Low Clearance Areas

While the maximum height for a vehicle is 14 feet, bus drivers need to be mindful of the clearance required to safely drive under bridges or underpasses, some of which can go as low as 10 feet. Nevada Department of Transportation requires that any vehicle or load have at least three inches of clearance. For example, the Pumpernickel underpass at Interstate 80 in Humboldt county has a height of 13'9". This means that you cannot pass under if your total height is over 13'6". DOT maintains a list of low clearance locations [here](#).

Be aware that bridge height may change without notice and if you have concerns about a route, you can contact the Over-Dimensional Vehicle Permit office to have the route verified.

Federal Bridge Formula

As trucks became heavier in the 1950's and 1960's, the Federal Bridge Formula was created to protect our bridges. The formula links allowable weights to the number and spacing of axles.

$$WW = 500 \frac{L^3}{L - 1} + 12LL + 36$$

W= Overall gross weight on any group of two or more consecutive axles to the nearest 500 lbs.

L= Distance between the outer axles of any group of two or more consecutive axles.

N= The number of axles in the group under consideration.

Weight Limits

23 U.S.C. 127 limits gross vehicle weight to 80,000 lbs. Single axles are limited to 20,000 lbs. and axles spaced between 40 and 96 inches apart are limited to 34,000 lbs.

Applying the Formula to School Buses

Using a Type C bus with 23 feet (L) between 2 axles (N) at 70% capacity with students weighing an average of 160 pounds we can calculate the total weight of the bus with passengers at 28,100 pounds. If we insert the length between axles and number of axles into the formula, we should get

a number that is greater than or equal to the total weight of the bus.

$$\begin{aligned}
 & 23(2) \\
 WW &= 500 \overbrace{(2) \underline{1}}^{46} + 12(2) + 36 \\
 &= 500 \overbrace{1}^{46} + 24 + 36 \\
 WW &= 500[46 + 24 + 36] \\
 WW &= 500[106] \\
 WW &= 53,000
 \end{aligned}$$

W= 53,000. This means that the bus at a total gross weight of 28,100 pounds is cleared to travel over bridges.

Unit 1.1.2 Control Systems/Dashboard

This unit must introduce driver-trainees to vehicle instruments, controls, and safety components. The training providers must teach driver-trainees to read gauges and instruments correctly and the proper use of vehicle safety components, including safety belts and mirrors. The training providers must teach driver-trainees to identify, locate, and explain the function of each of the primary and secondary controls including those required for steering, accelerating, shifting, braking systems (e.g., ABS, hydraulic, air), as applicable, and parking.

Vehicle Instruments, Controls, and Safety Components

Reading Gauges and Instruments Correctly

As a school bus driver, it is important to understand what information the gauges and instruments on your dashboard are relaying to you. Below are the basic control systems and their normal operating ranges.

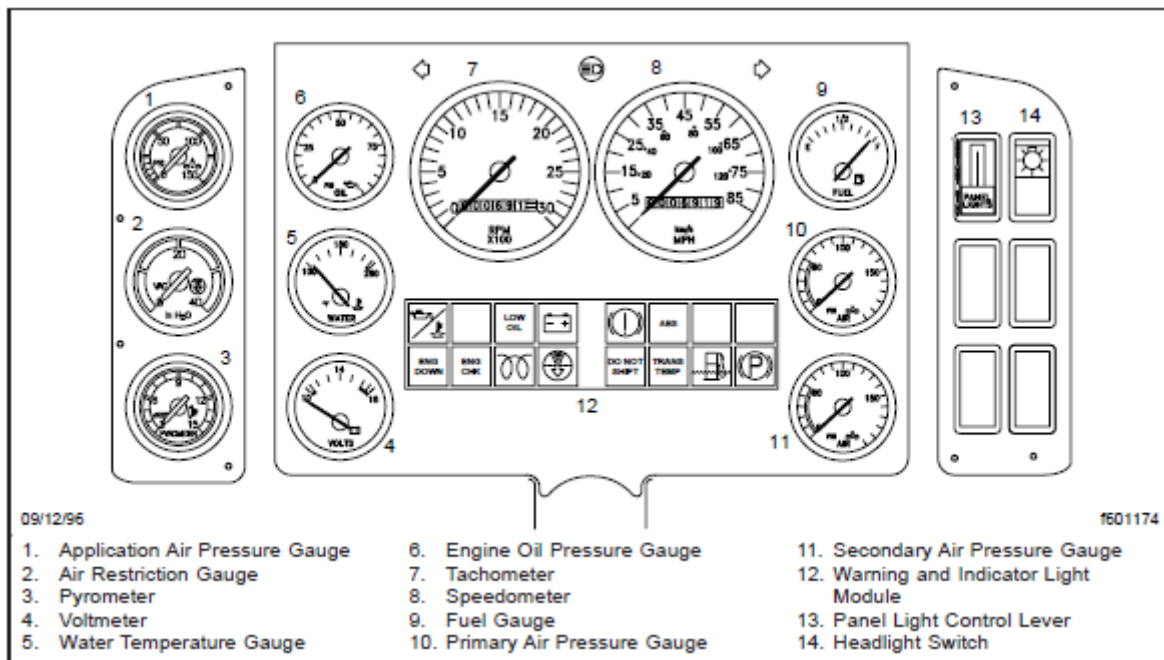

Oil Pressure

Oil pressure should reach and maintain operating range within a few seconds of starting the bus. Idle range is 5-20 PSI and operating range is 35-75 PSI.

Air Pressure

Pressure should build from 50 to 90 PSI within 3 minutes. Air pressure should build to governor cut-out of 120-140 PSI.

Ammeter/Voltmeter

The Ammeter or Voltmeter indicates if the alternator is properly functioning. This should show the alternator charging at 12-16 volts.

Coolant

Typical operating range for coolant is 165 to 190°F. It should not drop below 160°F or go above 210°F.

Engine Oil Pressure

Typical operating range for engine oil pressure varies according to manufacture specifications. Ranges can be between 30 and 70.

Warning Lights and Buzzers

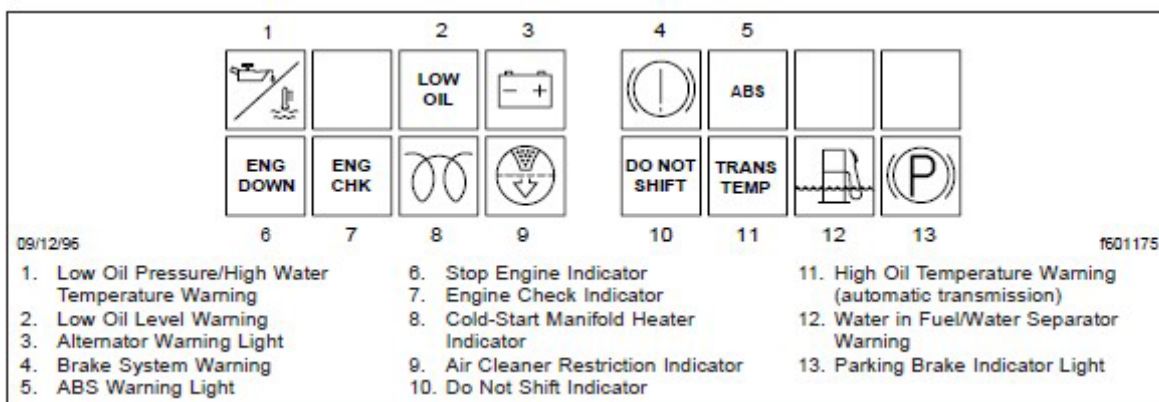

Warning lights and buzzers should switch off within a few seconds of starting the school bus.

Emergency Warning devices

At least three (3) reflectorized triangle road-warning devices mounted in an accessible place ([Federal Motor Carrier Safety Regulation 392.22, Emergency Signals, Stopped Commercial Motor Vehicles](#)).

Fire Extinguishers

The school bus shall be equipped with at least one UL-approved pressurized, dry chemical fire extinguisher. The extinguisher shall be secured in a mounted bracket, located in the driver's compartment and readily accessible to the driver and passengers. A pressure gauge shall be mounted on the extinguisher and shall be easily read without moving the extinguisher from its mounted position.

The fire extinguisher shall have a rating of 5 B:C, or greater. The operating mechanism shall be secured with a type of seal that will not interfere with the use of the fire extinguisher ([National School Transportation Specifications and Procedures, 2015](#), pg. 38).

Spare Fuses

When required, at least 1 spare fuse or other loaded protective devices if the devices used are not of a reset type of each kind and size used.

Lap/Shoulder Restraint Systems in School Buses

All drivers are required to wear their seatbelt while operating a vehicle.

The National Transportation Safety Board (NTSB), as a result of school bus crash investigations, has recommended that new school buses should provide children with the best protection available, which includes 3-point seat belts ([National Transportation Safety Board, School Bus Safety Report](#)).

In November 2015, the National Highway Traffic Safety Administrator (NHTSA) announced that all school buses should have three-point seat belts. The National Highway Traffic Safety Administration, Update on Lap/Shoulder Belts in School Buses have reported:

1. A dramatic reduction in behavior and discipline problems.
2. Improved safety and a reduction in crashes due to driver's being less distracted.
3. Increased driver satisfaction with driver's now asking for buses equipped with lap/shoulder belts.
4. Strong parent satisfaction.
5. All new school buses purchased in Nevada on or after before July 1, 2019, will be required to be equipped with 3-point restraint systems ([Nevada Revised Statute 386.837](#)).

Steering Wheel

A steering wheel (also called a driving wheel or a hand wheel) is a type of steering control in vehicles.

The steering wheel is the part of the steering system that is manipulated by the driver; the rest of the steering system responds to such driver inputs.

Accelerator

The accelerator in a car or any vehicle controls the flow rate of the fuel into the combustion chamber. Whenever we apply the accelerator, it opens the throttle valve which increases fuel input to the engine, therefore increasing the speed of the vehicle.

Shifting

A gearshift or shifter (US English) is a metal lever attached to the shift assembly in a manual transmission-equipped automobile and is used to change gears. In an automatic transmission-equipped vehicle, a similar device is known as a gear selector.

Mirrors

Mirrors must be adjusted properly before beginning your trip.

Parking

Only park where it is safe and legal to do so and ensure your parking brake is set.

Unit 1.1.3 Pre-and Post-Trip Inspections

This unit must teach the driver-trainees to conduct pre-trip and post-trip inspections as specified in [§ 392.7](#) and [§ 396.11](#), including appropriate inspection locations. Instruction must also be provided on en-route vehicle inspections.

Inspection Test

In order to obtain a CDL, you will be required to pass a Vehicle Inspection test. You will be tested to see if you know whether your school bus is safe to drive or not. *You will be asked to explain what you would inspect and why* ([Nevada Commercial Driver License Manual](#), pg. 11- 1).

**If you inspect your school bus the same way each time
you will be less likely to miss anything.**

While approaching your school bus, notice the general condition. Look for damage or bus leaning to one side. Look under the vehicle for fresh oil, coolant, grease, or fuel leaks. Check the area around the vehicle for hazards to vehicle movement (people, other vehicles, objects, low- hanging wires, limbs, etc.).

Required Inspections

1. Pre-trip (before the trip);
2. During a trip security inspection;
3. Post-trip, (after the trip/run/route and student check); and
4. Enroute vehicle inspections.

Major Components of a Pre-Trip Inspection

You must be able to identify each safety-related part on the school bus and name, point to or touch and fully explain what needs to be inspected ([Nevada Commercial Driver License Manual](#), pg. 11- 1) and [Federal Motor Carrier Safety Regulation 383.113, Required Skills](#)).

- 1) Vehicle Overview/Approaching the school bus;
- 2) Engine compartment (engine off);
- 3) Cab Check/Engine Start;
- 4) External Inspection;
- 5) Steering;
- 6) Suspension;
- 7) Brakes;
- 8) Wheels;
- 9) Side of vehicle;
- 10) Rear of vehicle;
- 11) Wheelchair lifts and securement systems (if equipped); and

- 12) School bus specific equipment.

Inspection Criteria

All inspection components marked with an OOS in the lists below mean that this is an Out-of-Service item that requires the school bus be placed out of service if the inspection identifies that something is out of compliance; the bus may not be used again until all OOS items have been fixed and have passed another inspection. Items on this list are applicable to all CMVs.

Vehicle Overview/Approaching the School Bus

- 1) Review the most recent vehicle inspection report. Drivers must inspect and report any violations. Your employer must repair any items in the report and certify that the required repairs have been made.
- 2) Observe the overall physical appearance and condition of the bus.
- 3) Look under the bus for fresh oil, coolant, grease, or fuel leaks on the ground.
- 4) Check the area around the bus for hazards, vandalism, or tampering.

Engine Compartment (Engine Off)

- 1) Check that the parking brakes are on and/or the wheels are chocked before you do the following:
 - a) **Leaks and hoses (OOS Item).** Look for puddles on the ground and dripping fluids on the underside of the engine transmission. Inspect hoses for condition and leaks. Check that air hoses, electrical lines, and electrical line insulation are not cracked, chafed, spliced, taped, or worn. Check that air and electrical lines are not tangled, crimped, pinched, or showing wear marks.
 - b) **Oil level.** Be able to indicate where the dipstick is located, and to check that the oil level is within the safe operating range. The oil level must be above the refill mark on the dipstick.
 - c) **Coolant level.** Inspect the radiator's reservoir sight glass, if equipped. If not equipped, remove radiator cap, and check for visible coolant level. Check to make sure that the unit (radiator) is mounted securely and does not have any leaks or damage of any kind.
 - d) **Power steering fluid.** Indicate where power steering fluid dipstick is located. Check for adequate power steering fluid level. The power steering fluid level must be above refill mark on the power steering fluid dipstick.
 - e) **Engine compartment belts.** Check the following belts for snugness (up to $\frac{3}{4}$ inch play at center of belt), cracks, or frays:
 - i) Power steering belt
 - ii) Water pump belt
 - iii) Alternator belt
 - iv) Air compressor belt

NOTE: If any of the components listed above are not belt driven, you must tell the examiner which

components are not belt driven and make sure that the component(s) are operating properly, are not damaged or leaking, and are mounted securely.

- f) **Hydraulic brakes master cylinder and brake fluid.** Check that the master cylinder is securely attached and not leaking. Check the level of brake fluid in the reservoir to ensure it is between the “add” and “full” marks.
- g) **Windshield fluid level, connections, and tiedowns** (note: windshield fluid pump battery may be located elsewhere). Check the reservoir level to ensure it is between the “add” and “full” marks.
- h) **Automatic transmission fluid level.** Check the dipstick and see where the fluid level is relative to the refill mark. Level must be above refill mark ([Nevada Commercial Driver License Manual](#), pg.11-1).
- i) **Air Compressor.** With the engine off, locate the air compressor. Check that the compressor is securely mounted and not leaking or damaged in any way. Determine if the compressor is belt or gear driven. If the compressor is belt driven, test the belt to make sure it is snug. Check that the belt is not frayed, has no visible cracks, loose fibers, or signs of wear. Push the belt with your hand, and if it deflects more than $\frac{1}{2}$ to $\frac{3}{4}$ of an inch, note that the slippage is probably excessive.
- j) **Safe start.** Place gearshift lever in neutral (or park, for automatic transmission). Depress clutch before attempting to start the vehicle. Start the vehicle and keep clutch depressed until engine reaches idling speed. Then release clutch slowly.

External Inspection

- 1) Walk around and do a general inspection of the bus. Ensure that nothing looks out of place, broken, or not secured.
- 2) **Steering box/hoses.** Check that the steering box is securely mounted and not leaking. Look for missing nuts, bolts, and cotter keys.
- 3) Check for **power steering fluid** leaks or damage to power steering hoses.
- 4) **Steering linkage.** Ensure that connecting links, arms, and rods from the steering box to the wheel are not worn or cracked.
- 5) Check that **joints and sockets** are not worn or loose and that there are no missing nuts, bolts, or cotter keys.

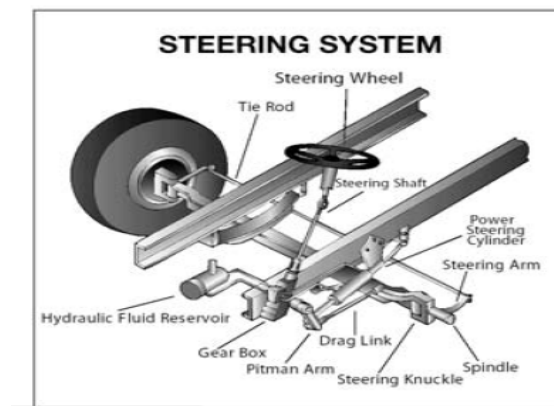

6) Suspension (OOS Item)

- a) **Springs/air/torque.** Look for missing, shifted, cracked, or broken leaf springs:
 - i) Look for broken or distorted coil springs.
 - ii) If vehicle is equipped with torsion bars, torque arms, or other types of suspension components, check that they are not damaged and are mounted securely.
 - iii) Air ride suspensions should be checked for damage and leaks.

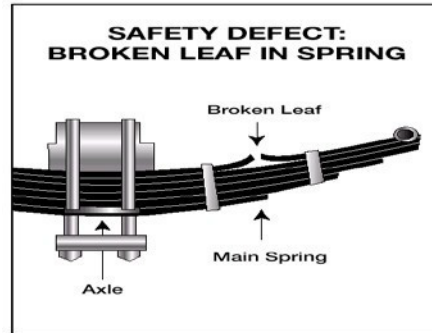

- b) **Mounts.** Look for cracked or broken spring hangers, missing or damaged bushings, and broken, loose, or missing bolts, U-bolts or other axle mounting parts (the mounts should be checked at each point where they are secured to the vehicle frame and axle(s)).
 - c) **Shock absorbers.** Ensure that shock absorbers are secure and that there are no leaks. Check that air bag mounts (bolts) are in place and not damaged. Check air-ride suspension for damage and leaks. Be prepared to perform the same suspension components inspection on every axle.
- ## 7) Brakes (OOS Item)
- a) **Slack adjusters and pushrods.** Look for broken, loose, or missing parts. For manual slack adjusters, the brake pushrod should not move more than one inch (with the brakes released) when pulled by hand.

- b) **Brake chambers.** Ensure that all brake chambers are not leaking, cracked, or dented and are mounted securely.
 - c) **Brake hoses/lines.** Look for cracked, worn, or leaking hoses, lines, and couplings.
 - d) **Drum brake/disc brakes.** Check for cracks, dents, or holes. Check for loose or missing bolts. Check for contaminants, such as debris or oil/grease.
 - e) **Brake linings.** On some brake drums, there are openings where the brake linings can be seen from outside the drum. For this type of drum, check that a visible amount of brake lining is showing. **Note:** Be prepared to perform the same brake components inspection on every axle ([Nevada Commercial Driver License Manual](#), pg. 11-3).
- 8) **Wheels (OOS Item)**
- a) **Rims.** Check for damaged or bent rims. Rims cannot have welding repairs.
 - b) **Tires.** The following items must be inspected on every tire:
 - i) **Tread depth.** Check for minimum tread depth (4/32 on steering axle tires, 2/32 on all other tires).
 - ii) **Tire condition.** Check that tread is evenly worn and look for cuts or other damage to tread or sidewalls. Also, make sure that valve caps and stems are not missing, broken, or damaged.
 - iii) **Tire inflation.** Check for proper inflation by using a tire gauge. **Note:** You will not get credit for simply kicking the tires to check for proper inflation.
 - c) **Hub oil seals/axle seals.** See that hub oil/grease seals and axle seals are not leaking and, if wheel has a sight glass, that the oil level is adequate.
 - d) **Lug nuts.** Check that all lug nuts are present, free of cracks and distortions, and show no signs of looseness, such as rust trails or shiny threads. Make sure all bolt holes are not cracked or distorted.
 - e) **Spacers or budd spacing.** If equipped, check that spacers are not bent, damaged, or rusted through. **Note:** Be prepared to perform the same wheel inspection on every axle ([Nevada Commercial Driver License Manual](#), pg. 11-4).
- 9) **Side of Vehicle (OOS Item)**
- a) **Door(s)/mirror(s).** Check that doors are not damaged and that they open and close properly from the outside (includes emergency exits).
 - b) **Hinges** should be secure, and the seals should be intact.
 - c) Check that **mirrors** and **mirror brackets** are not damaged.
 - d) **Fuel tank.** Check that tank is secure, cap is tight, and there are no leaks from tank or lines.
 - e) **Driveshaft.** Ensure that the driveshaft guard is not loose, missing, improperly placed, or bent. Universal joint(s) should not be worn or faulty, or have obvious welded repair ([National School Transportation](#), pg. 86).

- f) **Exhaust system.** Check system for damage and signs of leaks such as rust or carbon soot. System should be connected tightly and mounted securely. If equipped with emissions after-treatment, check the diesel exhaust fluid (DEF) tank to ensure that the level of diesel exhaust fluid in the tank is adequate (more than 1/8th tank).
- g) **Frame.** Look for cracks, broken welds, holes, or other damage to the longitudinal frame members, cross members, box, and floor.

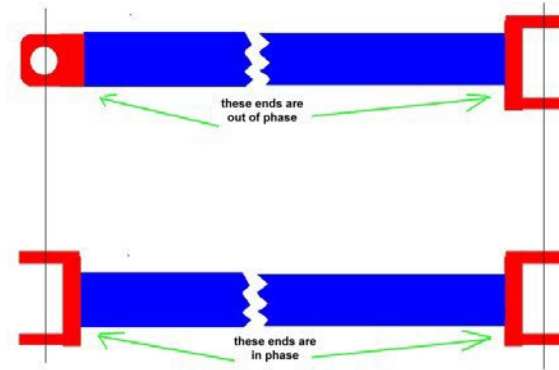

10) Rear of vehicle (OOS Item)

- a) **Splash guards.** If equipped, check that splash guards or mud flaps are not damaged and are mounted securely.
- b) **Doors/ties/lifts.** Check that doors and hinges are not damaged and that they open, close, and latch properly from the outside, if equipped.
- c) **Dash Indicators for Lights (OOS Item).** Test that dash indicators work when corresponding lights are turned on:
 - i) Left turn signal;
 - ii) Right turn signal;
 - iii) Four-way emergency flashers;
 - iv) High beam headlight; and
 - v) Anti-lock Braking System (ABS) indicator
- d) Check that all **external lights** and **reflective equipment** are clean and functional, including:
 - i) Clearance lights (red on rear, amber elsewhere);
 - ii) Headlights (high and low beams);
 - iii) Taillights;
 - iv) Backing lights;
 - v) Turn signals;
 - vi) Four-way flashers;
 - vii) Brake lights;

- viii) Red reflectors (on rear) and amber reflectors (elsewhere); and
- ix) Reflector tape condition.

Note: Checks for brake, turn signals, and four-way flasher functions must be done in separate steps.

- e) Check that **baggage compartment doors** are not damaged, operate properly, and latch securely.

11) Cab Check/Engine Start

- a) **Oil pressure gauge.** Make sure that the oil pressure gauge is working. Check that the pressure gauge shows increasing or normal oil pressure or that the warning light comes on when inadequate oil pressure occurs. If equipped, oil temperature gauge should begin a gradual rise to the normal operating range once the engine has been started.



- b) **Temperature gauge.** Make sure that the temperature gauge is working. The temperature on the gauge should begin to climb to the normal operating range once the engine has been started, or temperature light should be off.
- c) **Air gauge.** Make sure that the air gauge is working properly. Build air pressure to governor cut-out, roughly 120-140 PSI.
- d) **Ammeter/voltmeter.** Check that gauges show alternator and/or generator is charging, or that the warning light is off.
- e) **Mirrors and windshield.** Mirrors should be clean and adjusted properly from the inside. Windshield should be clean with no illegal stickers, no obstructions, and no damage to the glass.
- f) **Emergency equipment.**
 - i) Check for spare electrical fuses. **Note:** If vehicle is not equipped with electrical fuses, you must mention this to the examiner.
 - ii) Check for three red reflective triangles.
 - iii) Check for a properly charged and rated fire extinguisher.
- g) **Wipers/washers (OOS Item).** Check that wiper arms and blades are secure, not damaged, and that they operate smoothly. If equipped, windshield washers must operate correctly.

- h) **Horn (OOS Item).** Check that horn works.
- i) **Heater/defroster (OOS Item).** Ensure that the heater and defroster work.
- j) **Parking brake check (OOS Item).** With the parking brake engaged, check that the parking brake will hold the vehicle by gently trying to pull forward while the parking brakes on.
- k) **Hydraulic brake check (OOS Item).** Pump the brake pedal three times, and then hold it down for five seconds. The brake pedal should not move (depress) during the five seconds.
 - i) If equipped with a hydraulic brake reserve (back-up) system, with the key off, depress the brake pedal and listen for the sound of the reserve system electric motor. Check that the warning buzzer or light is off.
- l) **Air brake check (OOS Item).** Failure to perform all three components of the air brake check correctly will result in an automatic failure of the vehicle inspection test. Air brake safety devices vary. However, this procedure is designed to see that any safety device operates correctly as air pressure drops from normal to a low air-condition.
 - i) For safety purposes, in areas where an incline is present, you will use wheel chocks during the air brake test.
 - ii) The proper procedures for inspecting the air brake system are as follows:
 - (1) With the air pressure built up to governor cutoff (120–140 PSI), shut off the engine leaving the key in the “on” or “battery charge” position, chock your wheels, if necessary, release the parking brake and fully apply the foot brake. Hold the foot brake for one minute. Check the air gauge to see if the air pressure drops more than three pounds in one minute.
 - (2) Begin fanning off the air pressure by rapidly applying and releasing the foot brake. Low air warning devices (buzzer, light, flag) should activate before air pressure drops below 55 PSI or level specified by the manufacturer.
 - (3) Continue to fan off the air pressure. At approximately 40 PSI the parking brake valve should close (pop out).

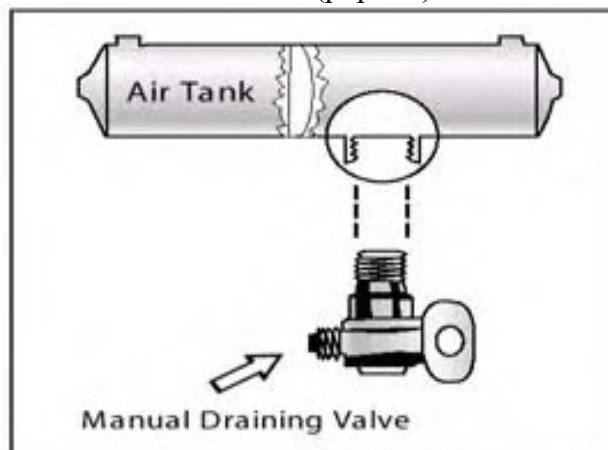

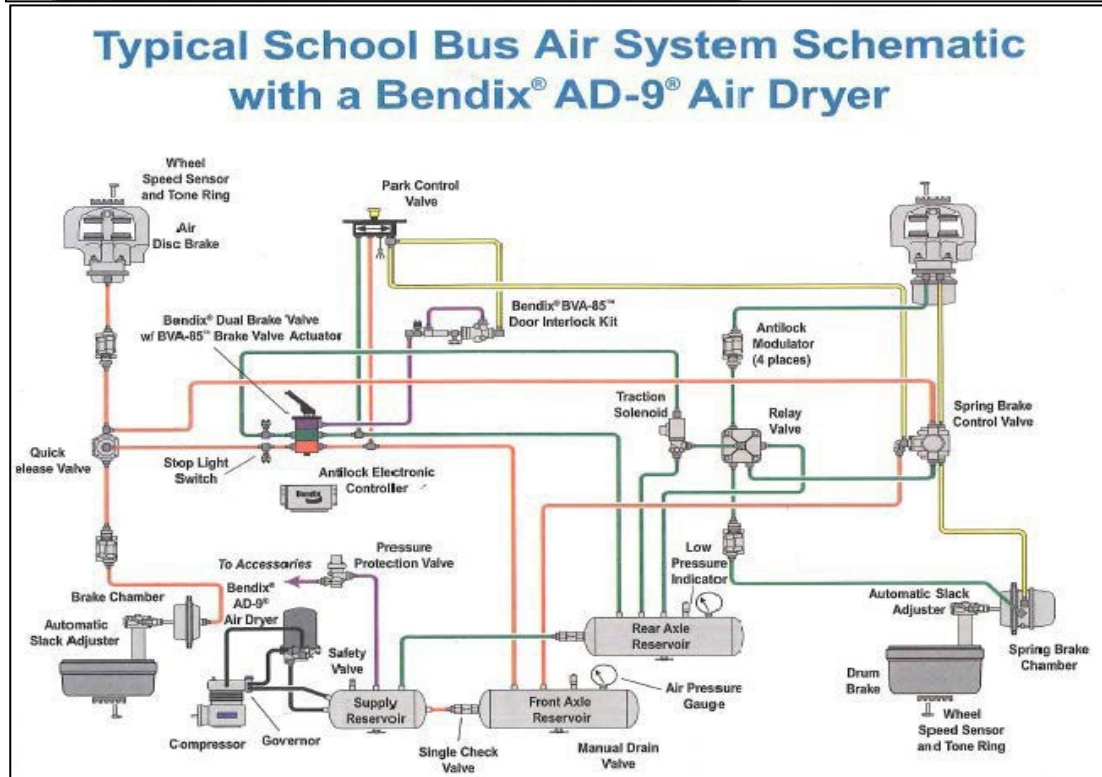
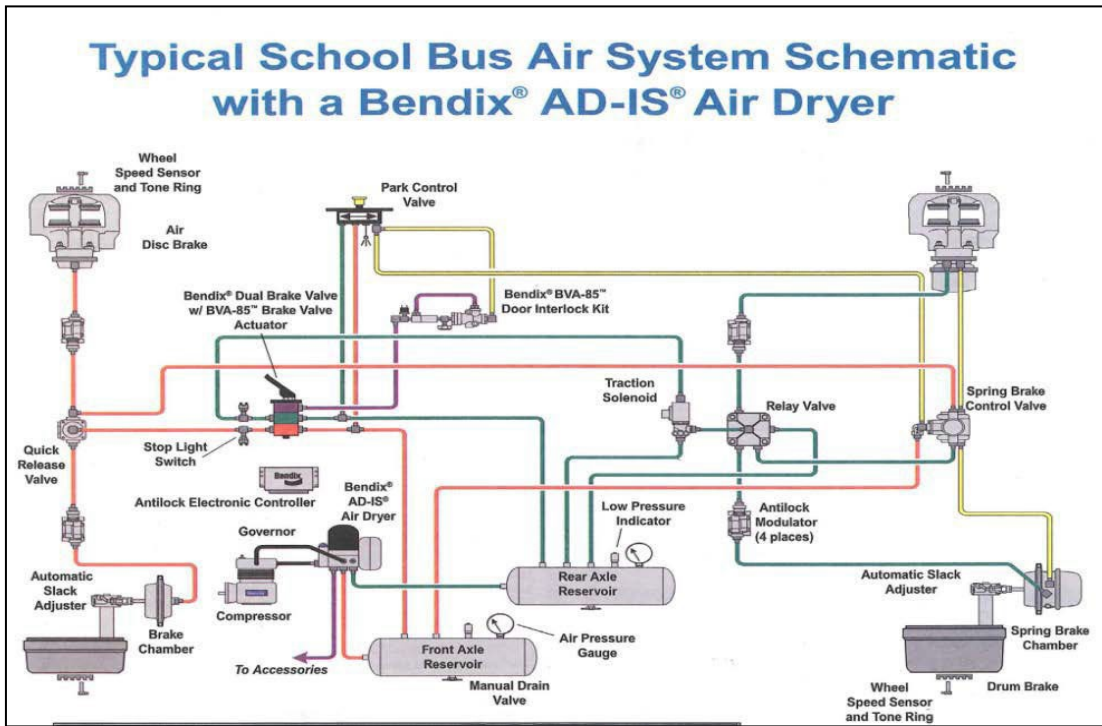

11) **Service brake (OOS Item).** You are required to check the application of air or hydraulic service brakes. This procedure is designed to determine that the brakes are working correctly, and that the vehicle does not pull to one side or the other.

- a) Pull forward at 5 mph, apply the service brake and stop. Check to see that the vehicle does not pull to either side and that it stops when brake is applied.
- 12) **Safety belt (OOS Item).** Check that the safety belt is securely mounted, adjusts, latches properly, and is not ripped or frayed ([Nevada Commercial Driver License Manual](#), pg. 11-3).

School Bus Specific Inspection Criteria

In addition to the requirements for inspecting all CMVs, school buses have equipment specific to the vehicle. These are the additional inspection criteria you need to know.

- 1) **Emergency equipment (OOS Item).** The following emergency equipment must be inspected.
 - a) **Fire extinguisher.** The bus shall be equipped with at least one UL-approved pressurized, dry chemical fire extinguisher ([National School Transportation Specifications and Procedures, 2015](#), pg. 38).
 - b) The extinguisher shall be secured in a mounted bracket, located in the driver's compartment, and readily accessible to the driver and passengers. A pressure gauge shall be mounted on the extinguisher and shall be easily read without moving the extinguisher from its mounted position.
 - i) The first extinguisher shall have a rating of 2-A:10-BC, or greater. The operating mechanism shall be secured with a type of seal that will not interfere with the use of the fire extinguisher.
 - c) **First aid and body fluid clean-up kits.** The bus shall have a removable, moisture-proof, and dust-proof first aid and body fluid clean-up kit in an accessible location.
 - i) The kit can be mounted or stored in a compartment. If mounted, it must be clearly labeled. If stored in a compartment, the compartment must be clearly labeled, easily accessible to the driver, and not blocked.
 - d) **Emergency warning devices.** The bus must be equipped with at least three reflectorized triangles that are stored in a secure location ([Federal Motor Carrier Safety Regulation 392.22, Emergency Signals: Stopped Commercial Motor Vehicles](#)).
- 2) **Lighting indicators (OOS Item).** In addition to checking the lighting indicators listed above in Lights school bus drivers must also check the following dash lighting indicators:
 - a) Alternately flashing amber lights indicator;
 - b) Alternately flashing red lights indicator; and
 - c) Strobe light indicator (if equipped).
- 3) **Lights/reflectors (OOS Item).** In addition to checking the lights and reflective devices listed above, school bus drivers must also check the following external lights and reflectors:
 - a) Strobe light (if equipped);
 - b) Stop arm light;

- c) Alternately flashing amber lights; and
 - d) Alternately flashing red lights.
- 4) **Mirrors (OOS Item)**. Check that all mirrors (inside student rear view mirror, crossover mirrors, flat mirrors, and convex mirrors):
 - a) Are properly adjusted;
 - b) Are not missing, damaged, clouded or obscured;
 - c) Are mounted securely with no loose fittings;
 - d) Visibility is not impaired due to being dirty; and
 - e) Holds a set when adjusted.
 - 5) **Stop arm (OOS Item)**. If equipped, check the stop arm to see it is mounted securely to the frame of the vehicle. Also, check for loose fittings and damage.
 - 6) **Passenger entry/lift (OOS Item)**. Check that the entry door is not damaged, operates smoothly, and closes securely from the inside.
 - 7) **Handrails** are secure and the step light is working.
 - 8) **Entry step** must be clear, with treads that are not loose or worn excessively.
 - 9) If equipped with a **handicap lift**, look for leaking, damaged, or missing parts, and explain how lift should be checked for correct operation. Lift must be fully retracted and latched securely.
 - 10) **Emergency exits (OOS Item)**. Make sure that all emergency exits are not damaged, operate smoothly, and close securely from the inside. Emergency Exit doors must be operational from inside and outside the school bus. Check that emergency exit warning devices are working.
 - 11) **Seating (OOS Item)**. Look for broken seat frames and check that seat frames are firmly attached to the floor. Check that seat cushions are attached securely to the seat frames ([Nevada Commercial Driver License Manual](#), pg. 11-6).

Wheelchair Lift Equipped Buses (OOS Item)



The following items will cause a wheelchair lift equipped bus to be put out of service.

- 1) Wheelchair lift does not function as designed or is inoperable.
- 2) Platform lift manufactured after April 1, 2005 that does not meet all the following criteria as referenced in [Federal Motor Vehicle Safety Standard 571.403, Platform Lift Systems for Motor Vehicles](#) and [Federal Motor Vehicle Safety Standard 571.404, Platform Lift](#)

Installation in Motor Vehicles.

- a) Jacking prevention;
- b) Manual backup operating mode;
- c) Interlocks to prevent forward or rearward mobility of the vehicle unless lift is stowed and doors are closed;
- d) Wheelchair retention device; and
- e) Platform outer barrier and inner roll stop.
- f) Any hydraulic line leaking during lift operation.
- g) Wheelchair restraint system that is missing, incomplete or improperly installed, loose or damaged ([National School Transportation Specifications & Procedures, 2015](#), pg. 94).
- h) Each wheelchair position has 4 securement straps. A lap belt, and a shoulder belt.
- i) Wheelchair restraint systems are properly stored when not secured to the bus.
- j) There is at least one belt cutter and emergency evacuation blanket.
- k) Retractors are working by pulling out the webbing to ensure they are locking properly.
- l) Webbing is not cut, frayed, damaged or contaminated.
- m) Metal parts are not worn, broken, or cracked.
- n) Pin connector bushings are not cracked, broken, or missing.
- o) Mounting hardware, such as bolts, nuts, etc. are secure.
- p) Floor anchorages are clean and secured.
- q) Buckles are not damaged and operate properly.

After-Shift Vehicle Inspection

You are required to inspect your bus at the end of each shift. The report must specify each bus and list any defect that would affect safety or result in a breakdown ([Nevada Commercial Driver License Manual](#), pg. 2-1).

Post-Trip Inspection Requirements

When your route or school activity trip is finished, you should conduct a post-trip inspection of the bus. You should walk through the bus and around the bus looking for the following.

- 1) Articles left on the bus
- 2) Sleeping students
- 3) Open windows and doors
- 4) Mechanical/operational problems with the bus, with special attention to items that are unique to school buses, such as mirror systems, flashing warning lamps and stop signal arms

- 5) Damage or vandalism
- 6) Any problems or special situations should be reported immediately to your supervisor or school authorities ([Nevada Commercial Driver License Manual](#), pg. 10-6).

Security Inspection-Anytime the Bus Is Left Unattended

Any time you leave your bus unattended for any length of time, you need to do a security inspection of your school bus and check the following areas for suspicious packages, devices, substances, or baggage.

- 1) Floors;
- 2) Below seats;
- 3) Driver's area;
- 4) Steps;
- 5) Wheelchair lifts (if equipped);
- 6) Lights;
- 7) Wheel wells;
- 8) Engine compartments;
- 9) Exhaust system;
- 10) Fuel and air tanks;
- 11) Emergency exit doors; and
- 12) Storage compartments.

After each trip, make sure to walk the school bus and check for students!

**Don't be the person who left a child on a school bus!
Check after each trip!**

Appropriate inspection location

The bus yard or parking lot or secure and safe location.

Unit 1.1.4 Basic Control

This unit must introduce basic vehicular control and handling as it applies to combination vehicles. This unit must include instruction addressing basic combination vehicle controls in areas such as executing sharp left and right turns, centering the vehicle, maneuvering in restricted areas, and entering and exiting the interstate or controlled access highway.

Accelerating

[Nevada Commercial Driver License Manual](#), (pg. 2-8)

When accelerating, **don't roll back** when you start. You may hit someone behind you. If you have a manual transmission vehicle, partly engage the clutch before you take your right foot off the brake. Put on the parking brake whenever necessary to keep from rolling back. Release the parking brake only when you have applied enough engine power to keep from rolling back.

Speed up smoothly and gradually so the vehicle does not jerk. Rough acceleration can cause mechanical damage.

Speed up gradually when traction is poor, as in rain or snow. If you use too much power, the drive wheels may spin. You can lose control if the drive wheels begin to spin, take your foot off of the accelerator.

Space for Turns

The space around a bus is important in turns. Because of wide turning and off-tracking, large vehicles can hit other vehicles or objects during turns.

- 1) **Right turns.** Here are some rules to help prevent right-turn crashes.
 - a) Turn slowly to give yourself and others more time to avoid problems.
 - b) If your bus cannot make the right turn without swinging into another lane, turn wide as you complete the turn. Keep the rear of your vehicle close to the curb.
 - c) Don't turn wide to the left as you start the turn. A driver may try to pass you on the right.
 - d) If you must cross into the oncoming lane to make a turn, watch out for vehicles coming toward you.

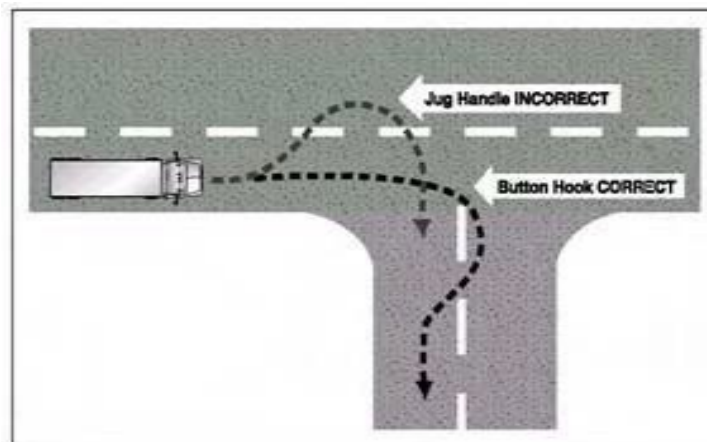

- 2) **Left turns.** On a left-hand turn, make sure you have reached the center of the intersection before you start the left turn. If you turn too soon, the left side of your vehicle may hit another vehicle because of off-tracking.
 - a) If there are two or more left hand turn lanes, always take the outside right turn lane. Don't start in the inside lane because you may have to swing right to make the turn.

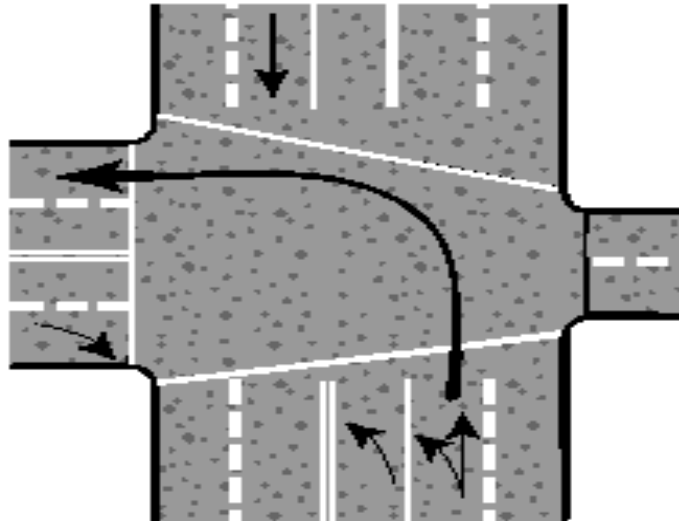

Staying Centered in a Lane.

You need to keep your vehicle centered in the lane to keep safe clearance on either side. If your vehicle is wide, you have little room to spare.

Space Needed to Cross or Enter Traffic

Be aware of the size and weight of your vehicle when you cross or enter traffic ([Nevada Commercial Driver License Manual](#), pg. 2-18). Here are some important things to keep in mind:

- 1) Because of the slow acceleration and the space large school buses require, you need a much larger gap to enter traffic that you would in your car.
- 2) Acceleration varies with the load. Allow more room if your school bus is loaded.
- 3) Before crossing a road, make sure you can get all the way across before traffic reaches you.

Right-Of-Way

Vehicle Right-of-Way Rules

- 1) When approaching an **intersection**, a driver shall yield the right-of-way to a vehicle which has entered the intersection.
- 2) When two vehicles **enter an intersection** from different highways at approximately the same time, the driver of the vehicle on the left shall yield the right-of-way.
- 3) When a vehicle enters an intersection controlled by a **traffic- control device that is inoperative**, the driver shall proceed as if a stop sign had been erected ([Nevada Revised](#)

[Statute 484B.250](#)).

- 4) A driver of a vehicle within an intersection intending to make a **left-hand turn** shall yield the right-of-way to any vehicle approaching from the opposite direction ([Nevada Revised Statute 484B.253](#)).
- 5) The driver of a vehicle shall stop or yield at a **clearly marked stop line**, or if there is none, before entering the crosswalk on the near side of the intersection, if there is none, then at the point nearest the intersection where the driver has a view of approaching traffic on the through highway ([Nevada Revised Statute 484B.257](#)).
- 6) The driver of a vehicle about to **enter or cross a highway** from a private road shall yield the right-of-way to all vehicles approaching on the highway ([Nevada Revised Statute 484B.260](#)).

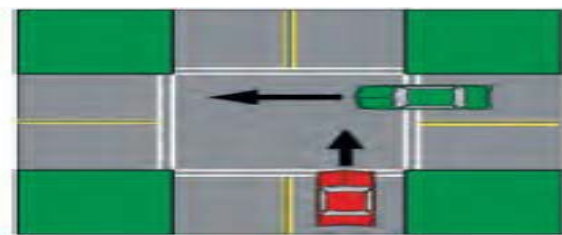
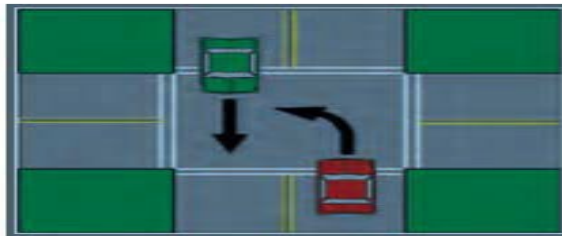

- 7) A driver of a vehicle, upon the immediate approach of an authorized **emergency vehicle**, making use of flashing lights, shall yield the right-of-way and immediately drive to a position parallel to, and as close as possible to the right-hand edge or curb of a highway clear of any intersection and shall stop and remain in such position until the authorized emergency vehicle has passed.
- 8) If the emergency vehicle is moving in the same direction of travel, a driver shall not overtake the emergency vehicle ([Nevada Revised Statute 484B.267](#))

Bicycle Right-of-Way Rules

- 1) The driver of a vehicle shall not interfere with the movement of a **person riding a bicycle**. When overtaking or passing a bicycle, the driver shall exercise due care and:
 - a) Move to the lane to the immediate left if the lane is available.
 - b) If there is only one lane of traffic, pass to the left of the bicycle at a safe distance, which must not be less than 3 feet between any portion of the vehicle and the bicycle.
- 2) The driver of a vehicle shall yield the right-of-way to any person riding a bicycle.

- 3) The driver of a vehicle shall not enter, stop, stand, park or drive within a pathway or lane provided for bicycles ([Nevada Revised Statute 484B.270](#)).

Pedestrian Right-of-Way Rules

In 2019 there were 62 pedestrian fatalities in Nevada!
[Zero Fatalities Crash Facts](#)

A driver of a motor vehicle shall exercise due care to avoid a collision with a pedestrian ([Nevada Driver Handbook](#), pg. 61).

Pedestrians facing a green light may cross the intersection unless a pedestrian signal or police officer directs otherwise. If a crosswalk is marked, pedestrians are to use the marked area.

- 1) Pedestrians facing a green turn arrow are not to cross unless a pedestrian signal or police officer allows them to do so.
- 2) Pedestrian walk and don't walk signals are special stop and go lights for pedestrians. If these signals are in place, pedestrians are to obey them. This may also be indicated by a lighted pedestrian figure or hand symbol in the signal:
 - a) Walk means pedestrians facing the signal may cross the street or highway in the direction of the signal.
 - b) Don't walk, if flashing, means the signal is changing. Pedestrians may not start across the roadway. However, if you are partly across when this begins flashing, you may continue to the sidewalk or safety island.
 - c) Don't walk, if constant, means pedestrians are not to cross.
 - d) Both drivers and pedestrians are responsible for safe use of our roadways. Drivers should always be prepared to yield to pedestrians and bicyclists.
 - e) You must yield the right-of-way to a pedestrian crossing in a marked or unmarked crosswalk when the pedestrian is upon the half of the highway upon which the vehicle is traveling, or when the pedestrian is approaching so closely from the opposite half of the highway as to be in danger ([Nevada Revised Statute 484B.283](#)).
 - f) A person who is blind and who is on foot and using a service animal, carrying a cane or walking stick white in color, or white tipped with red, has the right-of-way when entering or when on a highway, street, or road. When approaching such a person, a driver shall yield the right-of-way, come to a full stop, and take precautions before proceeding to avoid a crash or injury of the person ([Nevada Revised Statute 484B.290](#)).



Freeway Driving

Entering a Freeway

- 1) Be sure to use the on-ramp when you enter the freeway. Signs will say “Do Not Enter” and “Wrong Way” if you have made a mistake.
- 2) Using the merge or acceleration lane, look for an opening in traffic, use your turn signal and accelerate to the speed of freeway traffic. Do not stop before merging unless absolutely necessary; a stop can mean a slow and dangerous start into fast-moving traffic and can affect traffic behind you.
- 3) As you enter from a merging lane, you must yield to traffic already on the freeway. If you are already traveling on the freeway, watch for merging traffic and adjust your speed to allow safe and smooth merges.
- 4) Stay alert! Be prepared for rapid changes in road conditions and traffic flow. Search farther down the road – at least 20 to 30 seconds.
- 5) Watch traffic all around you. Be aware of other drivers who are changing lanes, passing, or slowing down.
- 6) Use your mirrors, doing a 5-count mirror check and look quickly over your shoulder before changing lanes. Use your turn signals to let other drivers know your plans and watch for their signals ([Nevada Driver Handbook](#), pg. 36).
- 7) Stay with the flow of traffic without exceeding the maximum speed.
- 8) Freeways have several lanes in each direction. On these roads, you should leave the extreme left lane for faster traffic.

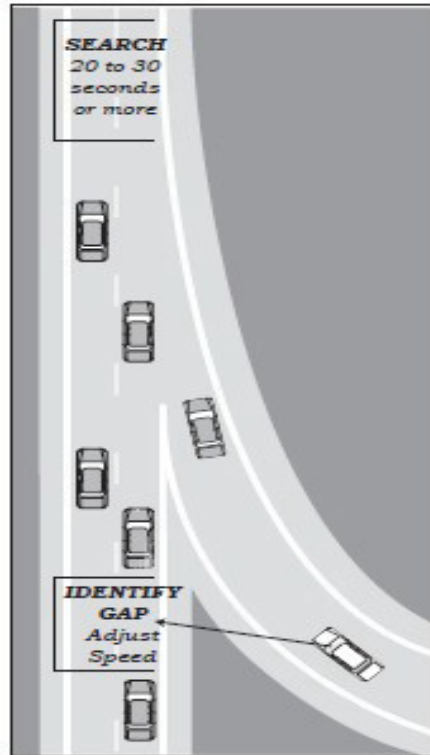

School buses **ARE NOT ALLOWED** to travel in HOV (high occupancy vehicle) or express lanes.

Exiting a Freeway

- 1) Most freeway exits have a special lane for you to use before you reach the exit ramp. Avoid slowing down on the freeway itself.
- 2) Wait until you are in the exit lane. Then, slow gradually until your speed matches the posted exit ramp speed.
- 3) Look ahead for signs telling you about the exit you want and the lane you need to use.
- 4) Do a 5-count mirror check, signal and move into the proper lane a mile or more before the exit. Most exits are numbered to help you quickly spot the one you want to take.
- 5) If you miss the exit ramp, never turn around or back up. Go to the next exit, get back on the freeway in the opposite direction, and return to the exit you want ([Nevada Driver Handbook](#), pg. 40).

Ramp Meters, High Occupancy Vehicle (HOV) Lanes And Roundabouts

Ramp Meters

- 1) If a freeway entrance is equipped with ramp meters and they are turned on, you must:
 - a) Pull up to the stop line and stop on red;
 - b) Be alert because the signal will change faster than a signal at an intersection; and
 - c) Wait for the green light. Then proceed along the ramp and merge onto the freeway safely.

- 2) Some freeway entrance ramps have more than one travel lane and each lane is controlled by its own ramp meter. School buses should be in the farthest right lane.
- 3) Some metered freeway ramps have HOV bypass lanes also known as carpool lanes. These lanes are marked with a diamond on the pavement and are not metered. School buses may enter the freeway in these HOV lanes ([Nevada Driver Handbook](#), pg. 37).



High Occupancy Vehicle (HOV) Lanes

If there is an HOV bypass lane (also known as a carpool lane) while entering a freeway, marked with a diamond on the pavement, and the lane is not metered, school buses can use the HOV lane without stopping ([Nevada Driver Handbook](#), pg. 37 and [NRS 484A.460](#)).

Roundabouts

A roundabout is a large circular area in the middle of an intersection meant to control the right-of-way of vehicles. It is a traffic management tool that moves traffic through an intersection without the aid of traffic signals.

- 1) When entering traffic, you must yield the right-of-way to the traffic circulating within the roundabout and decrease speed while traveling in one direction with traffic already in the roundabout.
- 2) When approaching a roundabout:
 - a) Choose which lane to use as you would for any other intersection.
 - b) Use the left lane to turn left, complete a U-turn or go straight.
 - c) Use the right lane to turn right or go straight.
 - d) Yield to those in the roundabout who have the right-of-way. Wait for a gap in the traffic.
 - e) Decrease your speed to travel with the traffic already in the roundabout.
 - f) Use your right turn signal when exiting.
- 3) Drive (usually with just the rear wheels) on the raised pavement of the truck apron to navigate more easily ([Nevada Driver Handbook](#), pg. 44).

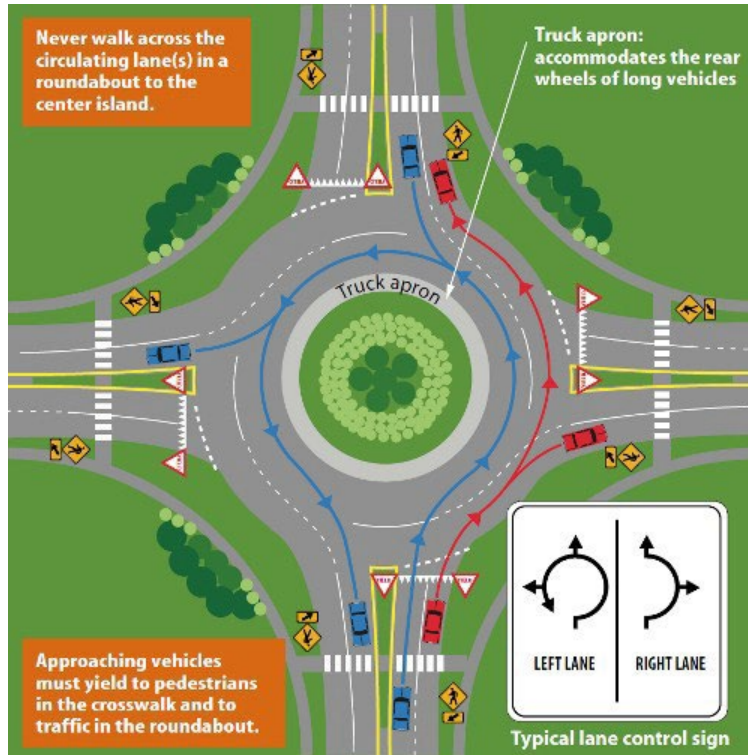

If approached by an emergency vehicle or official vehicle with flashing lights, you shall immediately drive to a position parallel to, and as close as possible to, the right-hand edge or curb of a highway clear of any intersection and shall stop and remain until the emergency vehicle has passed.

Unit 1.1.5 Shifting/Operating Transmissions

This unit must introduce shifting patterns and procedures to driver-trainees to prepare them to safely and competently perform basic shifting maneuvers. This unit must include training driver-trainees to execute up and down shifting techniques on multi-speed dual range transmissions, if appropriate. The training providers must teach the importance of increased vehicle control and improved fuel economy achieved by utilizing proper shifting techniques.

Changing Gears on a Standard Transmission

Basic Method for Shifting Up. Most heavy vehicles with unsynchronized manual transmissions require double clutching to change gears. If equipped with a synchronized manual transmission, double clutching is NOT required.

- 1) Release accelerator, push in clutch, and shift to neutral at the same time.
- 2) Release clutch.
- 3) Let engine and gears slow down to the RPM required for the next gear.
- 4) Push in clutch and shift to the higher gear at the same time.
- 5) Release clutch and press accelerator at the same time.

Shifting gears using double clutching requires practice. If you remain too long in neutral, you may have difficulty putting the vehicle into the next gear. If so, don't try to force it. Return to neutral, release clutch, increase engine speed to match road speed, and try again.

Knowing When to Shift Up.

There are two ways of knowing when to shift:

- 1) Use Engine Speed (RPM). Study the driver's manual for your vehicle and learn the operating RPM range. Watch your tachometer and shift up when your engine reaches the top of the range. Some newer vehicles use "progressive" shifting - the RPM at which you shift becomes higher as you move up in the gears. Find out what is right for the vehicle you will operate.
- 2) Use Road Speed (mph). Learn what speeds each gear is good for. Then, by using the speedometer, you'll know when to shift up.

With either method, you may learn to use engine sounds to know when to shift.

Basic Procedures for Shifting Down.

- 1) Release accelerator, push in clutch, and shift to neutral at the same time.
- 2) Release clutch.
- 3) Press accelerator, increase engine and gear speed to the RPM required in the lower gear.
- 4) Push in clutch and shift to lower gear at the same time.
- 5) Release clutch and press accelerator at the same time.

Downshifting, like upshifting, requires knowing when to shift. Use either the tachometer or the speedometer and downshift at the right RPM or road speed.

Special Conditions Where You Should Downshift

Before Starting Down a Hill. Slow down and shift down to a speed that you can control without using the brakes hard. Otherwise, the brakes can overheat and lose their braking power.

Downshift before starting down the hill. Make sure you are in a low enough gear, usually lower than the gear required to climb the same hill.

Before Entering a Curve. Slow down to a safe speed, and downshift to the right gear before entering the curve. This lets you use some power through the curve to help the vehicle be more stable while turning. It also allows you to speed up as soon as you are out of the curve.

Braking Systems

ABS – Anti-lock Brake System/Automatic Brake System

An anti-lock braking system or anti-skid braking system (ABS) is an automobile safety system that allows the wheels on a motor vehicle to maintain tractive contact with the road surface according to driver inputs while braking, preventing the wheels from locking up (ceasing rotation) and avoiding uncontrolled skidding. An ABS warning light will come on when you initially start your bus but will turn off.

Hydraulic Braking Systems

A hydraulic braking system uses pistons filled with brake fluid to transfer the pressure created by pressing on the brake pedal to the brake pads. The pressure the driver applied to the entire pedal is transferred to piston, which has a much smaller surface area than the pedal. This fluid pressure is transferred to the brakes to stop the vehicle.

Air Brakes

Similar to the hydraulic braking system, a compressed air brake system uses compressed air to press on the piston to apply pressure to the brake pads.

Fuel economy will be improved by proper shifting techniques.

Unit 1.1.6 Backing and Docking

This unit must teach driver-trainees to back and dock the combination vehicle safely. This unit must cover “Get Out and Look” (GOAL), evaluation of backing/loading facilities, knowledge of backing set ups, as well as instruction in how to back with the use of spotters.

Backing with a Trailer

- 1) Turn the steering wheel in the opposite direction. Once the trailer starts to turn, turn the wheel the other way to follow the trailer.
- 2) **Back SLOWLY** to allow yourself time to make corrections.
- 3) **Use your mirrors** to see if the trailer is drifting from one side or another.
- 4) **Correct any drift** immediately by turning the steering wheel in the direction of the drift.
- 5) **Pull Forward** to reposition the vehicle and trailer as necessary.

Evaluating an Area for Backing

- 1) **Look UP.** Look for building overhang, awnings, power lines, tree branches or any other hazards.
- 2) **Look DOWN.** Look for object hazards, crosswalks, depressions in the ground or pavement, slopes, etc.
- 3) **Look AROUND.** Walk around your vehicle to fully understand the area you are working in. Check side clearances and adjust your mirrors if necessary.
- 4) **Signal your intentions** by honking your horn and turning on our four-way lights.

Required Backing, Parking, and Docking

During the Skills Test for your CDL, you could be tested on any one of the following movements:

- 1) Straight-Line Backing
- 2) Offset Backing (Right or Left)
- 3) Parallel Parking (Driver Side or Conventional)
- 4) Alley Dock

You will be scored based on four measures:

- 1) **Encroachments.** The examiner will score the number of times you touch or cross over an exercise boundary line or cone with any portion of your vehicle. Each encroachment will count as an error.
- 2) **Pull-ups.** When a driver stops and pulls forward to clear an encroachment or to get a better position, it is scored as a “pull-up”. Stopping without changing direction does not count as a pull-up. You will not be penalized for initial pull-ups. However, an excessive number of pull-ups, will count as errors.

- 3) **Outside Vehicle Observations (Get out and look).** You may be permitted to safely stop and exit the vehicle to check the external position of the vehicle (look).
 - a) When doing so, you must place the vehicle in neutral and set the parking brake(s).
 - b) Then, when exiting the vehicle, you must do so safely by facing the vehicle and always maintaining three points of contact with the vehicle (when exiting a bus, always maintain a firm grasp on the handrail).
 - c) If you do not safely secure the vehicle or safely exit the vehicle it may result in an **automatic failure** of the basic control skills test.
 - d) The maximum number of times that you may look to check the position of your vehicle is two (2) except for the Straight-Line Backing exercise, which allows one look.
 - e) Each time you open the door, move from a seated position where in physical control of the vehicle or on a bus walk to the back of a bus to get a better view, it is scored as a “look.”
- 4) **Final Position/Inside Parallel.** It is important that you finish each exercise exactly as the examiner has instructed you. If you do not maneuver the vehicle into its final position as described by the examiner, you will be penalized and could fail the basic skills test.

Straight-Line Backing

Straight-Line backing is backing the vehicle in a straight line between two rows of cones without touching or crossing over the exercise boundaries.

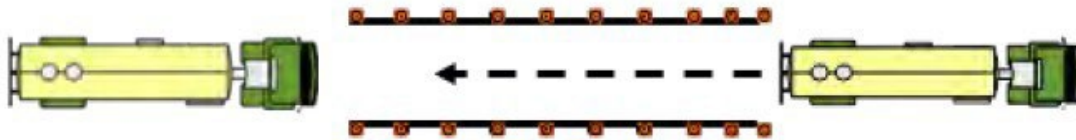

Offset Backing

Offset backing is backing the vehicle into a space that is to the rear of the vehicle and off to one side.

- 1) Start by driving the vehicle forward past the outer boundary.
- 2) From that position, back the vehicle into the opposite lane until the front of the vehicle has passed the first set of cones without striking any cones or crossing any boundaries.

Offset Right

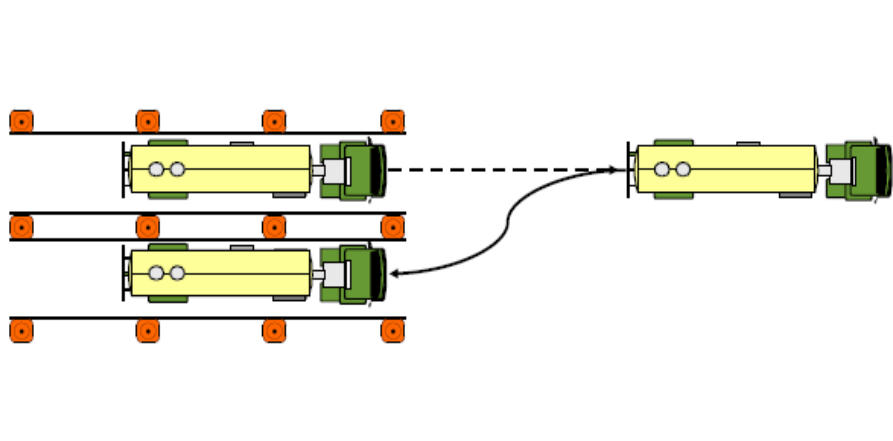

Offset Left

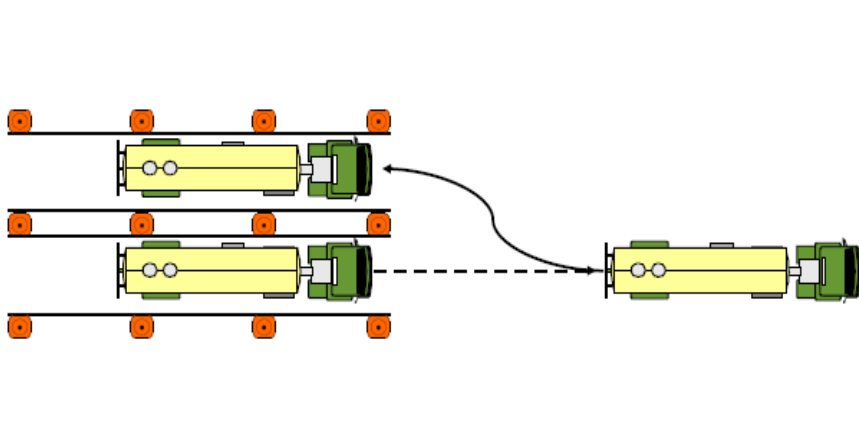

Parallel Parking

Parallel parking may be done on the left (Driver Side) or right (Conventional).

- 1) Drive past the entrance to the parallel parking space with your vehicle parallel to the parking area.
- 2) Back into the space without crossing the front, side, or rear boundaries marked by cones.
- 3) The entire vehicle must be in the space.

Parallel Park (Driver's Side)

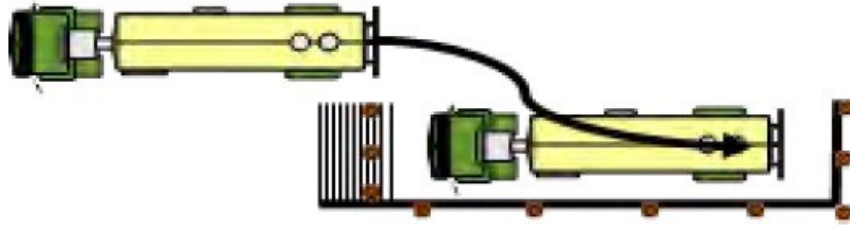

Parallel Park (Conventional)

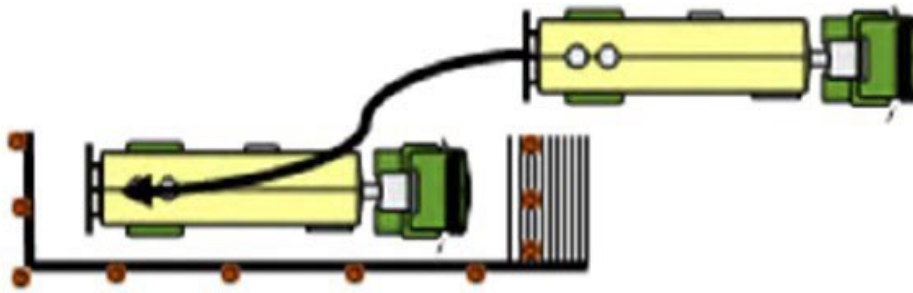

Alley Dock

Alley Docking is done on the sight-side of the vehicle.

- 1) Drive past the alley and position your vehicle parallel to the outer boundary.
- 2) Back into the alley bringing the rear of your vehicle within three feet of the rear of the alley without touching boundary lines or cones.
- 3) You are required to get the entire vehicle into the space.

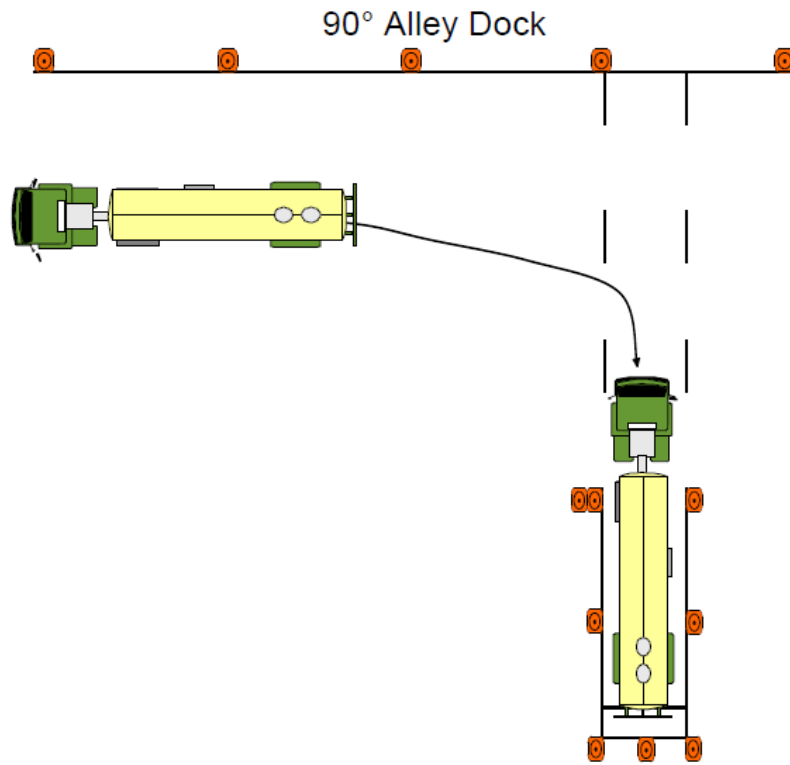

Use of spotters

Recommended when backing. You may use an adult outside the vehicle, never use a student.

Section 1.2 Safe Operating Procedures

This section must teach the practices required for safe operation of the combination vehicle on the highway under various road, weather, and traffic conditions. The training providers must teach driver-trainees the Federal rules governing the proper use of seat belt assemblies ([§ 392.16](#)).

Unit 1.2.1 Visual Search

This unit must teach driver-trainees to visually search the road for potential hazards and critical objects, including instruction on recognizing distracted pedestrians or distracted drivers. This unit must include instruction in how to ensure a driver-trainee's personal security/general awareness in common surroundings such as truck stops and/or rest areas and at shipper/receiver locations.

Scan, Identify, Predict, Decide, Execute (SIPDE)

SIPDE is an acronym for the process used to make judgements and take action in traffic. It stands for:

- 1) Scan
- 2) Identify
- 3) Predict
- 4) Decide
- 5) Execute

Scan

Scan over various points in front of you. On an open highway look about a quarter mile or about 15 seconds ahead of you. In a city you may be limited to 1 or 2 blocks ahead of you. Slow down to be safe. This will give you time react. Search aggressively for potential hazards. Scanning provides you with the information you need to make your decisions in enough time to take action.

Identify

Scanning a quarter mile ahead gives you time to identify what a potential hazard is. Locate hazards and potential conflicts. The hazards you encounter can be divided into three groups based on how critical their effect on you may be.

- 1) ***Cars, trucks, and other vehicles*** - They share the road with you, they move quickly, and your reactions to them must be quick and accurate.
- 2) ***Pedestrians and animals*** - They are characterized by unpredictability and short quick moves.
- 3) ***Stationary objects*** - Chuckholes, guard rails, bridges, roadway signs, hedges, or rows of trees won't move into your path, but may create or complicate your riding strategy.

The greatest potential for a conflict between you and other traffic is at intersections. An intersection can be in the middle of an urban area or at a driveway on a residential street- anywhere other traffic may cross your path of travel. Most motorcycle/automobile collisions occur at intersections. And most of these collisions are caused by an on-coming vehicle turning left into the path of the motorcycle. Your use of SIPDE at intersections is critical.

Before you enter an intersection, search for:

- 1) Oncoming traffic that may turn left in front of you.
- 2) Traffic from the left.
- 3) Traffic from the right.
- 4) Traffic approaching from behind.

Be especially alert at intersections with limited visibility. Be aware of visually "busy" surroundings that could camouflage you and your motorcycle.

Predict

Anticipate how the hazard may affect you. The moving direction of a potential hazard is important. Clearly, a vehicle moving aware from you is not as critical as a vehicle moving in your path. Determine the effect of the hazard - i.e., where a collision might occur. How critical is the hazard? How probable is a collision? This is the "What if...?" phase of SIPDE that depends on your knowledge and experience. Now estimate the consequences of the hazard. How might the hazard- or your effort to avoid it-affect you and others?

Decide

Determine how to reduce the hazard. There are only three things you can do:

- 1) ***Communicate your presence.*** Communication is the most passive action you can take since it depends on the response of someone else. Use your lights and horn, but don't rely on the actions of others
- 2) ***Adjust your speed.*** Adjustments of speed can be acceleration, slowing or stopping.
- 3) ***Adjust your position.*** Adjustments of position can be changing lane position or completely changing direction.

In both cases, the degree of adjustment depends on how critical the hazard is and how much time and space you have. The more time and space you have to carry out your decision, the less amount of risk you'll encounter.

In areas of high potential risk, such as intersections, give yourself more time and space by reducing the time you need to react. Cover both brakes and the clutch and be ready with possible escape routes.

Execute

Carry out your decision. This is when you're riding skills come into play and this is where they must be second nature. The best decision will be meaningless without the skills to carry it out. Know your limits and ride within them.

Recognizing distracted pedestrians and drivers

If you see a pedestrian or driver looking at their phone. Consider them to be distracted. For drivers it is unlawful to use a phone while driving and many drivers will attempt to hide it. If you see a driver looking down, it is safe to assume there is a distraction of some kind.

Watch for swerving, pausing, and sudden breaking. A distracted driver may not maintain their lane. If the light goes green and they pause before entering it could be a sign their eyes are not on the road. Always leave plenty of space between you and other cars as a situation can always turn dangerous in an instant.

Security and personal awareness

There are many off the road threats you may encounter. If your stopped at a rest area, truck stop, or shipper/receiver location you do not want to become a target of criminal activity. Always be aware of other vehicles and people around you. Staying aware of your surroundings and exercising caution is key to safety.

Safety measures

To protect yourself keep your door locked at all times. Even if you are leaving your vehicle for a minute, turn off the engine, lock the doors, and keep hold of your keys. Anytime you are stopped thieves can attempt to gain access to your vehicle. Always leave yourself a way out. If confronted remain in the vehicle and call authorities for assistance.

If you are stopped anywhere watch out for people following you around. Avoid people who seem especially interested in your cargo. To protect your cargo back up to a wall or another vehicle so the door cannot be opened.

Use a heavy duty padlock at all times even when your trailer is empty. Keep copies of emergency numbers available. Cargo and vehicles can be replaced. You cannot. If you are ever involved in a dangerous event, always call 911 and report to your employer. Plan for the unexpected and be aware of your surroundings and knowing how to respond when in dangerous situations will ensure your safety.

Unit 1.2.2 Communication

This unit must instruct driver-trainees on how to communicate their intentions to other road users. Driver-trainees must be instructed in techniques for different types of communication on the road, including proper use of headlights, turn signals, four-way flashers, and horns. This unit must cover instruction in proper utilization of eye contact techniques with other drivers, bicyclists, and pedestrians.

Communicate your presence

Seeing and being seen are key. Seeing is your ability to focus on the road and not be distracted. Being seen is making your presence and attention known to others both on and off the road. This can be accomplished by effective communication. Effective communication can come by utilizing your headlights, turn signals, four-way flashers, horns, bus stop arms, and eye contact.

Headlights

When it is dawn, dusk, raining, snowing make yourself easier to see by using your low-beam headlights.

Four-way flashers

When you pull onto the side of the road or if you have to stop on the road such as unloading passengers or coming to a railroad crossing use the four-way emergency flashers. Especially at night will make your presence known. If you must stop on the side of the road, be sure to place your warning devices within 10 minutes.

Horn

Only use your horn when needed. You can use the horn to let others know you are there to help avoid a crash. Know that the horn can startle others and can be dangerous if used unnecessarily.

Signaling your Intentions

Signaling what you intend to do is important for safety. Here are some general rules for signaling.

- 1) **Turns.** There are three good rules for using turn signals:
 - **Signal early** well before you turn. This is the best way to keep others from trying to pass you;
 - **Signal continuously.** You need both hands on the wheel to turn safely. Don't cancel the turn signal until you have completed the turn; and
 - **Cancel your signal.** Don't forget to turn off your turnsignal after you've completed the turn (if you don't have self-cancelling signals).
- 2) **Lane changes.** Before changing lanes, put your turn signal on 100 feet before the turn in residential areas and 300 feet before the turn on a highway. Change lanes slowly and smoothly. That way a driver you may not see may have a chance to honk his/her horn or avoid your vehicle.

- 3) **Slowing down.** Warn drivers behind you when you plan to slow down. A few light taps on the brake pedal, enough to flash the brake lights, should be sufficient to warn drivers who are following you.
- 4) **Trouble ahead.** The size of your vehicle may make it hard for drivers behind you to see hazards ahead. If you see a hazard that will require slowing down, warn the drivers behind by tapping your brake lights and use your four-way hazard lights.
- 5) **Tight turns.** Most car drivers don't know how slowly you have to go to make a tight turn in a large vehicle. Give drivers behind you warning by braking early and slowing gradually.
- 6) **Stopping on the road.** Bus drivers sometime stop in the roadway to load and unload passengers, or to stop at a railroad crossing. Warn following drivers by tapping your brakes and don't stop suddenly.
- 7) **Drive slowly.** Drivers often do not realize how fast they are catching up to a slow vehicle until they are very close. If you must drive slowly, alert following drivers by turning on your emergency flashers ([Nevada Commercial Driver License Manual](#), pg. 2-11).
- 8) **Four Way Emergency Flashers.** You can use your four-way emergency flashers:
 - When you pull off the road and stop ([Nevada Commercial Driver License Manual](#), pg. 2-12).
 - When an unusual traffic hazard exists ([Nevada Revised Statute 484D.185](#)).
- 9) **When passing.** Whenever you are about to pass a vehicle, pedestrian, or bicyclist, assume they don't see you. They could suddenly move in front of your vehicle. When it is legal, tap the horn lightly or, at night, flash your lights from low to high beam and back. Drive carefully enough to avoid a crash even if they don't see or hear you.
- 10) **When it is hard to see.** At dawn, dusk, in rain, or snow, you need to make yourself easier to see. If you are having trouble seeing other vehicles, other drivers will have trouble seeing you. Turn on your lights. Use the headlights, not just the identification or clearance lights. Use the low beams; high beams can bother people in the daytime as well as at night.
- 11) **When parked at the side of the road.** When you pull off the road and stop, be sure to turn on the four-way emergency flashers. This is especially important at night.
- 12) **If you must stop.** If you must stop on a road or shoulder of any road, activate your four-way hazards, and put out your emergency warning devices within ten minutes. Place your emergency triangles in the appropriate locations for your circumstance.

Eye contact

Making eye contact with another driver, pedestrian, or cyclist is an effective communication technique. Eye contact allows you and others to acknowledge their presence. Eye contact when used with other means of communication such as head, or hand gestures you can communicate who will be yielding and help prevent an accident.

Note: When confronted by an aggressive driver avoid eye contact. See section on aggressive drivers.

Unit 1.2.3 Distracted Driving

This unit must instruct driver-trainees in FMCSRs related to distracted driving and other key driver distraction driving issues, including improper cell phone use, texting, and use of in-cab technology (e.g., §§ [392.80](#) and [392.82](#)). This instruction will include training in the following aspects: Visual attention (keeping eyes on the road); manual control (keeping hands on the wheel); and cognitive awareness (keeping mind on the task and safe operation of the CMV).

Distracted Driving

Driver distraction is anything that takes your attention away from driving. Whenever you are driving a vehicle and your full attention is not on the task of driving, you are putting yourself, your passengers, other vehicles, and pedestrians in danger. Distracted driving is fast becoming the common cause of collisions, resulting in injury, property damage, or death ([Nevada Commercial Driver License Manual](#), pg. 2-21).

Activities inside the bus that can distract your attention and include:

- Talking to passengers;
- Adjusting the radio, CD player or Bluetooth connections;
- Climate controls;
- Eating or drinking;
- Picking up something that fell;
- Talking on a cell phone or using a CB radio;
- Reading or sending text messages or using any type of telematics or electronic devices (such as navigation systems, pagers, personal digital assistant, computers, or tablets); and
- Daydreaming or other mental distractions.



Effects of Distracted Driving

The effects of distracted driving include slowed perception, which may cause you to be delayed in perceiving or completely fail to perceive an important event; delayed decision making and improper action, which can cause you to be delayed in taking the proper action to make incorrect

inputs to the steering, accelerator, or brakes ([Nevada Commercial Driver License Manual](#), pg. 2-21).

Distracted driving claimed 3,450 lives and injured 391,000 in motor vehicle crashes in 2016 alone.

[National Highway Traffic Safety Administration, Distracted Driving Facts](#)

Types of Distractions

There are many causes of distraction, all with the potential to increase risk.

- 1) **Physical distraction.** Causes you to take your hands off the wheel or eyes off the road, such as reaching for an object;
- 2) **Mental distraction.** Are activities that take your mind away from the road, such as engaging in conversation with a passenger or thinking about something that happened during the day; and
- 3) Both **physical and mental distraction.** An even greater chance of a crash happening ([Nevada Commercial Driver License Manual](#), pg. 2-21).

Do Not Drive Distracted

- 1) You need to be able to recognize other drivers who are engaged in any form of driving distraction. Not recognizing other distracted drivers can prevent you from perceiving or reacting correctly in time to prevent a crash. This includes:
 - a) Vehicles that may drift over the lane divider lines or within their own lane;
 - b) Vehicles traveling at inconsistent speeds;
 - c) Drivers who are preoccupied with maps, food, cigarettes, cell phones, or other objects; and
 - d) Drivers who appear to be involved in conversations with their passengers.
- 2) Give a distracted driver plenty of room and maintain your safe following distance.
- 3) Be careful when passing a driver who seems to be distracted. The other driver may not be aware of your presence, and they may drift in front of you ([Nevada Commercial Driver License Handbook](#), pg. 2-23).

Operating a CMV includes being temporarily stationary because of traffic, a traffic control device, or other momentary delays.

[Federal Motor Carrier Safety Regulation 392.80 \(c\) Definition](#)

Communication Devices

Two-Way Communication Devices

Two-way communication devices are essential to safety; however, their use is restricted to business purposes and emergencies only.

You are only allowed to use two-way communication devices if you are reporting a medical emergency, a safety hazard or criminal activity or if you are requesting assistance relating to a medical emergency, a safety hazard or criminal activity.

Cell/Mobile Phones/Tablets/Texting

The use of cell/mobile phones and tablets have many beneficial uses for the school bus driver, but there are prohibitions and restrictions on the use of these devices. Failure to follow federal and state laws and regulations could result in tickets, fines, and termination due to be disqualification to drive a CMV.

Federal regulations prohibit a driver from using a hand-held mobile telephone while driving/operating your personal vehicle or a school bus.

Driving is defined as operating a commercial motor vehicle with the motor running, including while temporarily stationary because of traffic, a traffic control device, or other momentary delays.

[Federal Motor Carrier Safety Regulation 392.80, Prohibition Against Texting and 392.82, Using a Hand-Held Mobile Telephone](#)

Driving/operating does not include when the driver has moved the vehicle to the side of, or off, a highway, and halted in a location where the vehicle can safely remain stationary ([Federal Motor Carrier Safety Regulation 392.80, Prohibition Against Texting](#)).

- 1) You are allowed to use your cell phone **ONLY WHEN:**
 - a) Reporting a medical emergency, a safety hazard or criminal activity or if requesting assistance related to a medical emergency, a safety hazard or criminal activity; or
 - b) Responding to a situation requiring immediate action to protect the health, welfare or safety of the driver or another person and stopping vehicle would be inadvisable, impractical, or dangerous ([Nevada Revised Statute 484B.165](#)).
- 2) Nevada law states that you shall not manually type or enter text into a cellular telephone or other handheld wireless communication device or send or read data using any such devices to access or search the Internet or to engage in non-voice communications with another person, including, without limitation, texting, electronic messaging, and instant messaging.
- 3) Texting while driving (in your vehicle or the school bus) is considered a serious traffic violation ([Nevada Commercial Driver License Manual](#), pg. 2-22).
- 4) The provisions of this section do not prohibit the use of a voice-operated global positioning or navigation system that is mounted/affixed to the vehicle ([NRS 484B.165](#)).

- 5) Texting does not include:
 - a) Inputting, selecting, or reading information on a global positioning or navigation system;
 - b) Pressing a single button to initiate or terminate a voice communication using a mobile phone; or using a device capable of performing multiple functions (e.g., fleet management systems, dispatching devices, smart phones, citizens band radios, etc.) ([Federal Motor Carrier Safety Administration 383.5](#)).

Eliminate your distractions

Your goal should be to eliminate all in-vehicle distractions before driving begins. Accomplishing this goal can be done by:

- 1) Turn off all personal communication devices. If you must use a mobile phone, make sure it is within close proximity, that it is operable while you are restrained, use an earpiece or the speaker phone function, use voice-activated dialing; or use the hands-free feature.
- 2) Familiarize yourself with your vehicle's features and equipment before you get behind the wheel.
- 3) Keep your eyes on the road. You can help reduce distractions by:
 - a) Adjust all vehicle controls and mirrors to your preferences prior to driving.
 - b) Pre-program radio stations and pre-load your favorite CDs.
 - c) Clear the vehicle of any unnecessary objects and secure cargo.
 - d) Review maps, program the GPS and plan your route before you begin driving. Don't attempt to read or write while you drive.
 - e) Avoid smoking, eating, and drinking while you drive. Leave early to allow yourself time to stop to eat.
- 4) Maintain control by keeping your hands on the wheel.
- 5) Maintain cognitive awareness. Don't engage in complex or emotionally intense conversations with other occupants. Secure commitment from other occupants to behave responsibly and to support the driver in reducing distractions.

Unit 1.2.4 Speed Management

This unit must teach driver-trainees how to manage speed effectively in response to various road, weather, and traffic conditions. The instruction must include methods for calibrating safe following distances under an array of conditions including traffic, weather and CMV weight and length.

Speed Management

Driving too fast is a major cause of fatal crashes. You must adjust your speed depending on driving conditions. This includes traction, curves, visibility, traffic, and hills.

Total Stopping Distance

Perception distance + Reaction distance + Brake lag distance (for vehicles with airbrakes) + Braking distance = **Total stopping distance**

- 1) **Perception distance.** Perception distance is the distance your vehicle travels in ideal conditions; from the time your eyes see a hazard until your brain recognizes it. Keep in mind certain mental and physical conditions can affect your perception distance. It can be affected greatly depending on visibility and the hazard itself.
 - a) The average perception time for an alert driver is 1 3/4 seconds. At 55 mph this accounts for 142 feet traveled.
- 2) **Reaction distance.** Reaction Distance is the distance you will continue to travel, in ideal conditions; while you are braking. At 55 mph on dry pavement with good brakes, it can take about 216 feet.
- 3) **Brake distance.** Brake distance is the distance your vehicle will travel, in ideal conditions; while you are braking. At 55 mph on dry pavement with good brakes, it can take about 216 feet. Air brake lag will also add about 32 feet to the total stopping distance when driving on dry pavement at 55 mph.
- 4) **Total stopping distance.** Your total stopping distance is the total minimum distance your vehicle has traveled, in ideal conditions; with everything considered, including perception distance, reaction distance and braking distance, until you can bring your vehicle to a complete stop. At 55 mph, your vehicle will travel a minimum of 419 feet.

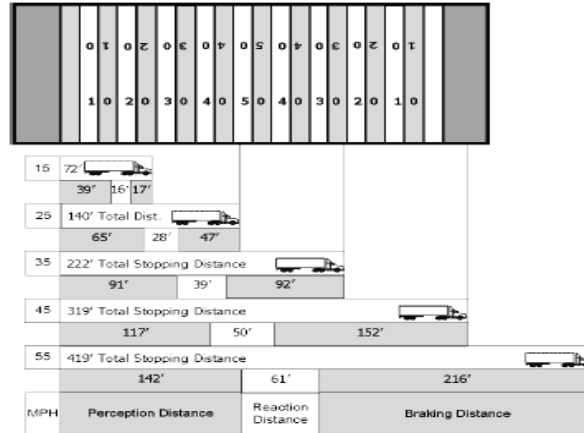

The Effect of Speed on Stopping Distance

The faster you drive, the greater the impact when you crash! When you double your speed from 20 to 40 mph the impact is 4 times greater. The braking distance is also 4 times longer. Triple the speed from 20 to 60 mph and the impact and braking distance is 9 times greater. At 60 mph, your stopping distance is greater than the length of a football field. Increase the speed to 80 mph and the impact and braking distance are 16 times great than at 20 mph. High speeds greatly increase the severity of crashes and stopping distances. By slowing down, you can reduce braking distance.

The Effect of Vehicle Weight on Stopping Distance

The heavier the vehicle, the more work the brakes must do to stop it and the more heat they absorb. But the brakes, tires, springs, and shock absorbers on heavy vehicles are designed to work best when the vehicle is fully loaded. Empty CMV's require greater stopping distances because an empty vehicle has less traction ([Nevada Commercial Driver License Manual](#), pg. 2- 14).

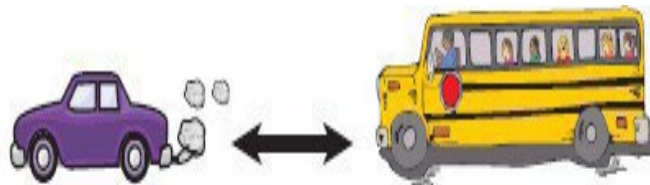

Speed and Curves

Drivers must adjust their speed for curves in the road ([Nevada Commercial Driver License Manual](#), pg. 2-15). If you take a curve too fast, two things can happen. The tires can lose their traction and continue straight ahead, so you skid off the road. Or the tires may keep their traction and the vehicle rolls over. Tests have shown that trucks with a high center of gravity can roll over at the posted speed limit for a curve.

Slow to a safe speed BEFORE you enter a curve. Braking in a curve is dangerous because it is easier to lock the wheels and cause a skid. Slow down as needed. Don't exceed the posted speed limit for the curve. Be in a gear that will let you accelerate slightly in the curve. This will help with control.

Speed and Distance Ahead

You should always be able to stop within the distance you can see ahead. Fog, rain, or other conditions may require that you slow down to be able to stop in the distance you can see. At night, you can't see as far with low beams as you can with high beams. If you must use low beams, slow down ([Nevada Commercial Driver License Manual](#), pg. 2-15).

Speed and Traffic Flow

When you're driving in heavy traffic, the safest speed is the speed of other vehicles. Vehicles going the same direction at the same speed are not likely to run into one another. Drive at the speed of the traffic if you can without going at an illegal or unsafe speed. Keep a safe following distance.

The main reason drivers exceed speed limits is to save time. But anyone trying to drive faster than the speed of traffic will not be able to save much time. The risks involved are not worth it. If you go faster than the speed of other traffic, you'll have to keep passing other vehicles. This increases the chance of a crash, and it is more tiring. Fatigue increases the chance of a crash.

When driving on slippery surfaces, NEVER USE engine brakes or CRUISE CONTROL!

[Nevada Commercial Driver License Manual](#), (pg. 2-15)

Speed on Downgrades

Your vehicle's speed will increase on downgrades because of gravity. Your most important objective is to select and maintain a speed that is not too fast for the:

- 1) Total weight of the vehicle and the passengers;
- 2) Length of the grade;
- 3) Steepness of the grade;
- 4) Road condition; and
- 5) Weather ([Nevada Commercial Driver License Manual](#), pg. 2-15).

Matching Speed to the Road Surfaces

You cannot steer or use your brakes to stop a vehicle unless you have traction. Traction is friction between the tires and the road. There are some road conditions that reduce traction and call for lower speeds.

Controlling Speed

Nevada's **Basic Rule** for driving at a "reasonable or proper" speed means that in addition to any posted speed limits you must consider:

- 1) The amount and type of traffic;
- 2) The weather and the distance you can see;
- 3) The condition of the road surface such as dry, wet, icy or snow covered;
- 4) The type of road. Is it flat and straight or steep and curve? Is it wide or narrow?

- 5) It also means that you are never to drive at a speed that endangers you or anyone else. Depending upon conditions, the safe speed may be considerably less than the posted speed limit.

Most people speed to save time. Let's look at how much or how little time is actually saved to travel 5 miles.

- At 70 mph takes 4 minutes, 17 seconds. Savings over 60 mph = 43 seconds.
- At 60 mph takes 5 minutes. Savings over 55 mph = 27 seconds.
- At 55 mph takes 5 minutes, 27 seconds. The next time you want to speed ask yourself:
 - 1) Why am I in a hurry?
 - 2) Does it really matter?
 - 3) Is it worth endangering myself and others ([Nevada Driver Handbook](#), pg.34)?

If you are stopped for speeding and given a ticket, it will cost you time, money and possibly your job!

Maximum Speed Limits for School Buses

[Nevada Revised Statute 484B.360](#)

- 1) School buses **SHALL NOT** exceed 55 mph when transporting students to and from school.
- 2) School buses **CAN** drive the posted speed limit when transporting students to and from activities (extra-curricular, sports, field trips) that are part of the school program.
- 3) School districts have the authority to establish a maximum speed limit.

Unit 1.2.5 Space Management

This unit must teach driver-trainees about the importance of managing the space surrounding the vehicle under various traffic and road conditions.

Managing Space

Space Ahead

- 1) Of all the space around your bus, it is the area ahead of your vehicle, the space you're driving into, that is most important. Vehicles most often run into the vehicle directly in front of them
- 2) In order to have enough space ahead, you need at least one second for each 10 feet of vehicle length at speeds below 40 mph. At greater speeds, you must add one second for safety.
- 3) One good rule says you need at least one second for each 10 feet of vehicle length at speeds below 40 mph. At greater speeds, you must add 1 second for safety. For example, if you are driving a 40-foot vehicle, you should leave 4 seconds between you and the vehicle ahead. In a 60-foot rig, you'll need 6 seconds. Over 40 mph, you'd need 5 seconds for a 40-foot vehicle and 7 seconds for a 60-foot vehicle.
- 4) To know how much space you have, wait until the vehicle ahead passes a shadow on the road, a pavement marking, or some other clear landmark. Then count off the seconds like this: one thousand- and-one, one thousand-and-two and so on, until you reach the same spot ([Nevada Commercial Driver License Manual](#), pg. 2-16).

Space Behind

You can't stop others from following you too closely. But there are things you can do to make things safer:

- 1) **Stay to the right.** School buses are heavy, slow-moving vehicles that are often tailgated. You can prevent other vehicles from tailgating your bus by traveling in the right lane.
- 2) **Tailgaters.** In large school buses, it is hard to see if a vehicle is close behind you. You may be tailgated:
 - a) If you are traveling slowly; and
 - b) Driving in bad weather.
- 3) **Dealing with tailgaters safely.** If you find yourself being tailgated, here are some things you can do to prevent the chances of a crash:
 - a) Avoid quick changes;
 - b) Increase your following distance;
 - c) Do not speed up; and
 - d) Avoid tricks that can aggravate other drivers ([Nevada Commercial Driver License Manual](#), pg. 2-17).

Space to the Sides

School buses are wide and take up most of a lane. Manage what little space you have by keeping your bus centered in your lane and avoid driving next to others. When traveling next to others you need to be extra cautious because:

- 1) Another driver may change lanes suddenly and turn into you;
- 2) You may be trapped when you need to change lanes;
- 3) You will not be able to leave yourself an out; and
- 4) Strong winds can make it difficult to maintain your lane ([Nevada Commercial Driver License Manual](#), pg. 2-17).

Space Cushion

The term Space Cushion refers to the clear area you should have around your vehicle. A space cushion is having an escape route if you need to take evasive action. If you cannot maintain your space cushion in one direction, you should be aware of it and leave yourself an out in another direction.

Space Overhead

Hitting overhead objects is a danger because school buses are large. You need to make sure you always have enough overhead clearance.

- 1) Never assume that the heights posted at bridges and overpasses are correct. Re-paving or packed snow may have reduced the clearance.
- 2) If you doubt you have enough safe space to pass under an object, take another route and notify your supervisor. Warnings are not always posted.
- 3) Some roads are uneven and may cause a vehicle to tilt.
- 4) There can be a problem clearing objects along the edge of the road.
- 5) Watch out for objects at the side of road like signs, tree branches, electrical wiring, or bridge supports. Always drive closer to the center of the road.
- 6) If you have to back into an area, get out and check for overhanging objects ([Nevada Commercial Driver License Manual](#), pg. 2-17).

School buses should never drive under an overhead that's less than 12 feet.

When Vehicles Are Required To Stop For School Buses

Vehicles are required to stop for school buses that are loading and unloading students. A driver must stop at any location for a school bus displaying a flashing red light STOP signal. The driver

may not attempt to overtake or proceed past the school bus until the school bus driver has turned off the flashing red stop arm lamps.

There is an exception to this rule; on divided highways, you need to stop only when you are traveling in the same direction as the school bus ([Nevada Driver Handbook](#), pg. 59).

Nevada law allows school bus drivers to report violations to the school district and the Department of Motor Vehicles. When this occurs, the registered owner of the vehicle will be sent a warning letter explaining the seriousness of the violation ([Nevada Revised Statute 484B.357](#)).

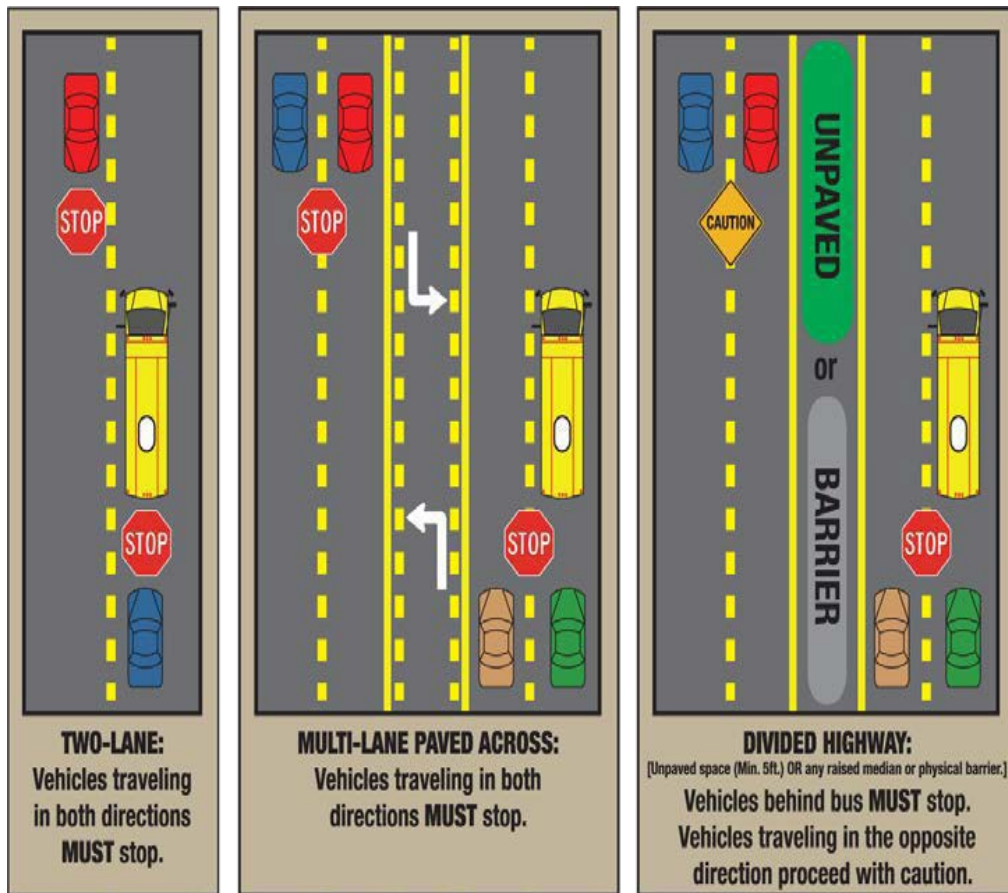

Definition of a Divided Highway

A Divided highway is a highway divided into two or more roadways by a physical barrier or dividing section, constructed so as to impede the conflict of vehicular traffic traveling in opposite directions ([Nevada Revised Statute 484A.070](#)).

Unit 1.2.6 Night Operation

This unit must instruct driver-trainees in the factors affecting the safe operation of CMVs at night and in darkness. Additionally, driver-trainees must be instructed in changes in vision, communications, speed, space management, and proper use of lights, as needed, to deal with the special problems night driving presents.

Driving at Night

Driving at night is always more difficult and hazardous than daytime driving. At night you cannot see as far, as soon or as much. The glare from oncoming headlights also adds to the difficulty. Here are some other factors that make night driving dangerous:

Driver Factors

Vision. People cannot see as clearly at night. Your eyes need time to adjust in dim light. Drivers need to have their eyes checked regularly by an eye doctor and wear glasses if required.

Glare. Drivers can be blinded by bright light. It can take several seconds to recover from glare. Even two seconds of glare blindness can be dangerous. Glare from your headlights can cause problems for drivers coming towards you. Dim your lights within 500 feet of an oncoming car.

Fatigue and lack of alertness. Fatigue (being tired) can be caused by physical or mental strain, repetitive tasks, illness, or lack of sleep. Just like alcohol and drugs, it impairs your vision and judgement.

Roadway Factors

Poor lighting. In the daytime there is usually enough light to see well. That is not true at night. Some areas may have bright streetlights, but many areas will have poor lighting. On most roads you will probably have to depend entirely on your headlights. Less light means you will not be able to see hazards as well as in the daytime. There are many crashes at night involving pedestrians, joggers, bicyclists, and animals ([Nevada Commercial Driver Manual](#), pg. 2-26).

Traffic signals and hazards can be hard to see against a background of signs, shop windows, and other lights.

Drunk drivers and drivers under the influence of drugs are a hazard to themselves and to you. Be especially alert around bars and taverns. Watch for drivers who have trouble staying in their lane or maintaining speed, stop without reason, or show other signs of being under the influence ([Nevada Commercial Driver Manual](#), pg. 2-26).

Vehicle Factors

At night your headlights will usually be the main source of light for you to see and for others to see you. You cannot see nearly as much with your headlights as you can see in the daytime. With low beams you can see 350-500 feet. You must adjust your speed to keep your stopping distance within your sight distance. This means going slowly enough to be able to stop within the range of

your headlights.

Dirty headlights may give only half the light they should. This cuts down on your ability to see and makes it harder for other to see you.

Other lights. In order for you to be seen easily, the following must be clean and working properly. This includes:

- 1) Reflectors;
- 2) Marker lights;
- 3) Clearance lights;
- 4) Taillights;
- 5) Identification lights;
- 6) Turn signals and brake lights;
- 7) Hazard lights; and
- 8) Brake lights.

Windshields and mirrors must be clean. Bright lights at night can cause dirt on your windshield or mirrors to create glare of its own.

Avoid blinding others. Glare from your headlights can cause problems for drivers coming toward you. They can also bother drivers going in the same direction you are when your lights shine in their rearview mirrors. Dim your lights within 500 feet of an oncoming vehicle and when following another vehicle within 500 feet.

Avoid glare from oncoming vehicles. Do not look directly at lights of oncoming vehicles. Look slightly to the right at a right lane or edge marking, if available. If other drivers don't put their low beams on, don't try to "get back at them" by putting your own high beams on.

Use high beams when you can. Some drivers make the mistake of always using low beams. This seriously cuts down on their ability to see ahead. Use high beams when it's safe and legal to do so. Use them when you are not within 500 feet of an approaching vehicle. Also, don't let the inside of your vehicle get too bright. This makes it harder to see outside. Keep the interior light off and adjust your instruments lights as low as you can to still be able to read the gauges.

Unit 1.2.7 Extreme Driving Conditions

This unit must teach driver-trainees the specific problems presented by extreme driving conditions. The training will emphasize the factors affecting the operation of CMVs in cold, hot, and inclement weather and on steep grades and sharp curves. The training providers must teach driver-trainees the proper tire chaining procedures in this unit.

Driving in Fog

Fog can occur at any time. Fog on highways can be extremely dangerous. Fog is often unexpected, and visibility can deteriorate rapidly. The best advice for driving in fog is DON'T! It is preferable that you pull off the road until visibility is better.

If your windows fog up, in addition to the defroster/fans, turn on your AC or open a window.

If you must drive in fog, be sure to do the following:

- 1) Slow down before you enter fog;
- 2) Use low-beam headlights and fog lights for best visibility even in daytime and be alert for other drivers who may have forgotten to turn on their lights;
- 3) Turn on your 4-way flashers. This will give vehicles behind you a quicker opportunity to notice your vehicle;
- 4) Watch for vehicles on the side of the roadway. Seeing taillights or headlights in front of you may not be a true indication of where the road is ahead of you. The vehicle may not be on the road at all;
- 5) Use roadside highway reflectors as guides to determine how the road may curve ahead of you;
- 6) Listen for traffic you cannot see;
- 7) Don't pass other vehicles;
- 8) Don't stop along the side of the road, unless absolutely necessary; and
- 9) Use the strobe light if your bus is equipped with one ([Nevada Commercial Driver Manual](#), pg.10-10, pg. 2-27).

Driving in Winter

When driving in winter, you need to pay extra attention to the following issues.



- 1) **Slippery surfaces.** Drive slowly and smoothly on slippery roads. If it is very slippery, you shouldn't drive at all. Stop at the first safe place. If driving on slippery surfaces, you should:
 - a) **Start gently and slowly.** When first starting, get the feel of the road. Don't hurry.
 - b) **Check for ice.** Check for ice on the road, especially bridges and overpasses. A lack of spray from other vehicles indicates ice has formed on the road. Also, check your mirrors and wiper blades for ice.
 - c) **Adjust turning and braking to conditions.** Make turns as gently as possible. Do not brake any harder than necessary, and don't use the engine brake or speed retarder (they can cause the driving wheels to skid on slippery surfaces).
 - d) **Adjust speed to conditions.** Don't pass slower vehicles unless necessary. Go slow and watch far enough ahead to keep a steady speed. Avoid having to slow down and speed up. Take curves at slower speeds and don't brake while in curves. Be aware that as the temperature rises to the point where ice begins to melt, the road becomes even more slippery. Slow down more.
 - e) **Adjust space to conditions.** Don't drive alongside other vehicles. Keep a longer following distance. When you see a traffic jam ahead, slow down or stop to wait for it to clear. Try hard to anticipate stops early and slow down gradually.
- 2) **Wet brakes.** When driving in heavy rain or deep standing water, your brakes will get wet. Water in the brakes can cause the brakes to be weak, to apply unevenly, or to grab. This can cause lack of braking power, wheel lockups, pulling to one side or the other.
 - a) Avoid driving through deep puddles or flowing water if possible ([Nevada Commercial Driver Manual](#), pg. 2-28). But if you cannot, you should:

- i) Slow down and place transmission in a low gear;
- ii) Gently put on the brakes. This presses linings against brake drums or discs and keeps mud, silt, sand, and water from getting in;
- iii) Increase engine RPM and cross the water while keeping light pressure on the brakes;
- iv) When out of the water, maintain light pressure on the brakes for a short distance to heat them up and dry them out; and
- v) Make a test stop when safe to do so. Check behind to make sure no one is following, and then apply the brakes to be sure they work right. If not, dry out further as described above.
- vi) **CAUTION:** Do not apply too much brake pressure and accelerator at the same time or you can overheat brake drums and linings ([Nevada Commercial Driver Manual](#), pg. 2-29).



3) **Ice and snow equipment.** You may be required to put chains on your bus when there is ice and snow on the ground. The maximum speed while driving with chains on is 30 mph.

4) **Snow chains**

- a) Automatic Chains are activated by a switch in the driver area and should be activated and deactivated when the bus is in motion at about 25-30 mph (this prevents damage to the chains).
- b) Automatic chains don't work in deep snow and should be deactivated as soon as they are not needed.
- c) Manually installed chains consist of 2 circular metal loops, one tire, which is connected by evenly spaced chains across the tire tread. There are three types of chain clamps:
 - i) Type 1-Chain with S-hook;
 - ii) Type 2-Cam locks; or
 - iii) Type 3-Cable Chains.
 - (1) To install manual chains, you will need to follow manufacturer and your trainer instructions.
 - (2) Tighteners are larger rubber bands that resemble a bungee cord and take up

slack in the chains and have 5 to 8 hooks that hook onto the chain links.



Avalanches

There were 15 avalanches reported to the [Sierra Avalanche Center](#) for the 2020-2021 season. That same season there was an avalanche in Elko county that [resulted in one fatality](#). While avalanches typically occur in backcountry or isolated areas, there is always a possibility that one can happen over a mountain highway. The advice for school bus drivers is the same for anyone else regarding avalanche preparedness and response.

- 1) Always check road conditions BEFORE you head out and try to keep additional food, water, warm clothes, and blankets in your bus.
- 2) If you come across avalanche debris, STOP, find a safe place to wait and call 911 to notify them of the debris blocking the roadway.
- 3) If your bus is hit by an avalanche, stay in your bus with the windows UP, turn off the engine (to prevent carbon monoxide from filling the bus), call 911, and stay calm and attend to any injuries.

Driving in Hot Weather

Nevada is a state of extremes and the most notable of those extremes is the heat in southern Nevada. Buses that run in the summer need to be particularly cautious as temperatures in the south can reach 117°F. When driving in hot weather, you need to pay special attention to:

- 1) **Tires.** Check the tire mounting and air pressure. Inspect the tires every 2 hours or 100 miles when driving in very hot weather. Air pressure increases with temperature. Do not let air out or the pressure will be too low when the tires cool off. If a tire is too hot to touch, remain stopped until the tire cools off. Otherwise, the tire may blow out or catch fire.
- 2) **Engine oil.** The engine oil helps keep the engine cool, as well as lubricating it. Make sure there is enough engine oil. Continually check the oil temperature gauge to make sure the temperature is within proper range while you are driving.
- 3) **Engine coolant.** Before starting out, make sure that the engine cooling system has enough water and antifreeze. When driving, check the water temperature and coolant temperature gauge from time to time. Make sure it remains in the normal range. If the gauge goes

above the highest safe temperature, there may be something wrong that could lead to engine failure and possibly fire.

- a) Some vehicles have sight glasses, see-through coolant overflow containers or coolant recovery containers. These permit you to check the coolant level while the engine is hot. If the container is not part of the pressurized system, the cap can be safely removed, and coolant added even when the engine is at operating temperatures.
- b) **Never remove the radiator cap or any part of the pressurized system until the system is cooled!** Steam and boiling water can spray under pressure and cause severe burns. If you can touch the radiator cap with your bare hand, it is probably cool enough to open.



- 4) **Engine belts.** Learn how to check belt tightness on your bus by pressing on the belts. Loose belts will not turn the water pump and/or fan properly. This will result in overheating. Also check the belts for cracking or other signs of wear. Check for tension or movement.
- 5) **Hoses.** Make sure coolant hoses are in good condition. A broken hose while driving can lead to engine failure and even fire.
- 6) **Bleeding tar.** Tar in the road pavement frequently rises to the surface in very hot weather. Spots where tar “bleeds” to the surface are very slippery.

Go slow enough to prevent overheating. High speeds create more heat for tires and the engine. In desert conditions the heat may build up to the point where it is dangerous. The heat will increase chances of tire failure or even fire, and engine failure ([Nevada Commercial Driver Manual](#), (pg. 2-29).

Driving in Mountains

Nevada has more than 300 named mountain ranges, all running north-south as part of the Great Basin complex and has the greatest number of peaks over 10,000 in elevation. Using this metric, Nevada is the most mountainous state in the Union. In mountain driving, gravity plays a major role. On any upgrade, gravity slows you down. The steeper and/or longer the grade and/or the heavier the load, the more you will need to use lower gears to climb hills or mountains. When driving in mountains, you must do the following:

- 1) When coming down, long steep downgrades, gravity causes the speed of your vehicle to increase. You must select an appropriate **Safe Speed**, then use a lower gear, and use proper braking techniques.
- 2) **Go slow.** This is so your brakes can hold you back without getting too hot. If the brakes become too hot, they may start to fade or glaze. This means you have to apply them harder and harder to get the same stopping power.

- 3) **Select a safe speed.** The most important consideration is to select a speed that is not too fast for the hill. Your **safe speed** includes:
 - a) Total weight of the vehicle and students;
 - b) Length of grade;
 - c) Steepness of the grade;
 - d) Road conditions; and
 - e) Weather.
- 4) If a speed limit is posted, or there is a sign indicating Maximum Safe Speed, never exceed the speed shown. Also, look for and heed warning signs indicating the length and steepness of the grade.
- 5) You must use the braking effect of the engine as the principal way of controlling your speed. The braking effect of the engine is greatest when it is near the governed RPMs and the transmission is in the lower gears. Save your brakes so you will be able to slow or stop as required by road and traffic conditions.
- 6) **Be in the right gear before starting down the grade.** Shift the transmission to a lower gear before starting down the grade. Do not try to downshift after your speed has already built up. You will not be able to get back into any gear and all engine braking affect will be lost. Forcing an automatic transmission into a lower gear at high speed could damage the transmission and lead to loss of all engine braking affect.
- 7) **Brake fading or failure.** Brakes can fail from excessive heat caused by using them too much and not relying on the engine braking effect ([Nevada Commercial Driver Manual](#), pg. 5-9). Use proper braking techniques on a long or steep downgrade:
 - a) Apply the brakes just hard enough to feel a definite slowdown;
 - b) When your speed has been reduced to approximately five mph below your safespeed, release the brakes. This brake application should last for about 3 seconds.
 - c) When your speed has increased to your safe speed, repeat steps 1 and 2; and
 - d) Escape ramps have been built on many steep mountain downgrades. Escape ramps are a long bed of loose soft material to slow a runaway vehicle ([Nevada Commercial Driver Manual](#), pg. 2-32).

You may be ticketed for improper use of an escape ramp

- 8) **Slow moving school buses.** When traveling on a mountain road that has one lane for traveling in each direction AND where passing is unsafe, the driver of a slow-moving school bus (defined as a vehicle traveling at a rate of speed less than the posted speed limit) shall do the following when five or more vehicles have formed a line behind the bus:

- a) Pull over at the nearest place designated as a turnout by signs erected by the public authority.
- b) In the absence of such a designated turnout, at the nearest place where sufficient area for a safe turnout exists and the circumstances and conditions are such that the driver is able to turn off the roadway in a safe manner ([Nevada Revised Statute 484B.630](#)).

Section 1.3 Advanced Operating Practices

This section must introduce higher-level skills that can be acquired only after the more fundamental skills and knowledge taught in the prior two sections have been mastered. The training providers must teach driver-trainees the advanced skills necessary to recognize potential hazards and must teach driver-trainees the procedures needed to handle a CMV when faced with a hazard.

Unit 1.3.1 Hazard Perception

The unit must provide instruction for recognizing potential hazards in the driving environment in order to reduce the severity of the hazard and neutralize possible emergency situations. The training providers must teach driver-trainees to identify road conditions and other road users that are a potential threat to the safety of the CMV and suggest appropriate adjustments. The instruction must emphasize hazard recognition, visual search, adequate surveillance, and response to possible emergency-producing situations encountered by CMV drivers in various traffic situations. The training providers must also teach driver-trainees to recognize potential dangers and the safety procedures that must be utilized while driving in construction/work zones.

Hazardous Conditions

Aggressive Drivers/Road Rage

Aggressive driving and road rage is not a new problem. However, in today's world, where heavy and slow-moving traffic and tight schedules are the norm, more and more drivers are taking out their anger and frustration in their vehicles.

Aggressive driving is the act of operating a motor vehicle in a selfish, bold, or pushy manner, without regard for the rights or safety of others.

Road rage is operating a motor vehicle with the intent of doing harm to others or physically assaulting a driver or their vehicle ([Nevada Commercial Driver License Manual](#), pg. 2-23).

Don't be an Aggressive Driver

- 1) Reduce your stress before and while you drive. Listening to easy music can help.
- 2) Give your drive your full attention. Don't allow yourself to become distracted.
- 3) Be realistic about your drive time. Expect delays because of traffic, construction, or bad weather and make allowances.
- 4) If you're going to be later than expected, deal with it. Take a deep breath and accept the delay.
- 5) Give other drivers the benefit of the doubt. Whatever their reason, it has nothing to do with you.
- 6) Slow down and keep your following distance reasonable.
- 7) Don't drive slowly in the left lane of traffic.

- 8) **No gestures!** Keep your hands on the wheel.
- 9) **Be a cautious and courteous driver.** Don't be offended by other driver's actions.

What to do When Confronted by an Aggressive Driver

- 1) First and foremost, make every attempt to get out of their way.
- 2) Put your pride in the back seat. Do not challenge them by speeding up or attempting to hold-your-own in your travel lane.
- 3) Avoid eye contact.
- 4) **Ignore gestures** and refuse to react to them ([Nevada Commercial Driver Manual](#), pg.2-24).

Move-Over Laws

The incidents of law enforcement and emergency medical services, fire department personnel and people working on the road are being struck while performing duties at the roadside are increasing at a frightening pace. Move-over laws have been enacted, which require drivers to slow and change lanes when approaching a roadside incident or emergency vehicle ([Nevada Commercial Driver Manual](#), pg. 2-18).

When approaching any traffic incident, the driver of the approaching vehicle shall, in the absence of other directions given by a law enforcement officer :

- 1) Decrease your speed;
- 2) Be prepared to stop;
- 3) If possible, drive in a lane that is not adjacent to the lane or lanes where the traffic incident is located; and
- 4) A traffic incident means any vehicle, person, conditions, or other traffic hazard which is located on or near a roadway and which poses a danger to the flow of traffic or to a person involved in, responding to, or assisting with a traffic hazard. This includes:
 - a) Emergency vehicles;
 - b) Towing vehicles;
 - c) Public Utility vehicles;
 - d) Governmental agencies;
 - e) Vehicles using their flashing warning lights;
 - f) A crash scene;
 - g) A stalled vehicle;
 - h) Debris in the roadway; or
 - i) A person who is out of his or her vehicle attending to a repair ([NRS 484B.607](#)).

Roadway Work Zones

When people are working on the road, it is a hazard. There may be narrower lanes, sharp turns, or uneven surfaces. Other drivers are often distracted and drive unsafely. Workers and construction vehicles may get in the way. Drive slowly and carefully near work zones. Use your four-way flashers or brake lights to warn drivers behind you. Speeding traffic is the number one cause of injury and death in roadway work zones. Observe the posted speed limits at all times when approaching and driving through a work zone. Watch your speedometer, and don't allow your speed to creep up as you drive through long sections of road construction. Decrease your speed for adverse weather or road conditions. Decrease your speed even further when a worker is close to the roadway.

Unit 1.3.2 Skid Control/Recovery, Jackknifing, and Other Emergencies

This unit must teach the causes of skidding and jackknifing and techniques for avoiding and recovering from them. The training providers must teach the importance of maintaining directional control and bringing the CMV to a stop in the shortest possible distance while operating over a slippery surface. This unit must provide instruction in appropriate responses when faced with CMV emergencies. This instruction must include evasive steering, emergency braking, and off-road recovery, as well as the proper response to brake failures, tire blowouts, hydroplaning, and rollovers. The instruction must include a review of unsafe acts and the role the acts play in producing or worsening hazardous situations.

Drive-wheel Skids

By far the most common skid is one in which the rear wheels lose traction through excessive braking or acceleration. Skids caused by acceleration usually happen on ice or snow. Taking your foot off the accelerator can easily stop them. If it is very slippery, push the clutch in. Otherwise, the engine can keep the wheels from rolling freely and regaining traction.

Rear wheel braking skids occur when the rear drive wheels lock. Because locked wheels have less traction than rolling wheels, the rear wheels usually slide sideways in an attempt to "catch up" with the front wheels. In a bus or straight truck, the vehicle will slide sideways in a "spin out." With vehicles towing trailers, a drive-wheel skid can let the trailer push the towing vehicle sideways, causing a sudden jackknife ([Nevada Commercial Driver's License Manual, pg. 2-37](#)).

Jackknifing

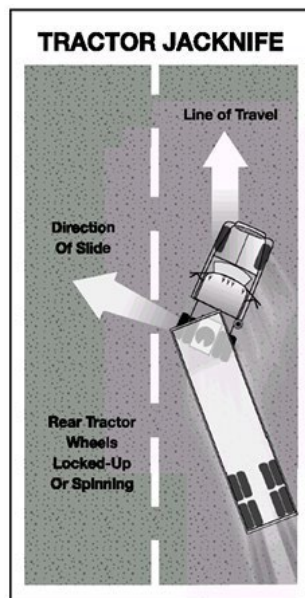

Don't over steer, over accelerate, or over brake. If you do, your vehicle may skid. On trailers, if your drive wheels or trailer wheels begin to skid, your vehicle may jackknife. When any vehicle starts to skid, you must take action to restore traction to the wheels. Jackknifing is when the tractor

begins to skid and it isn't corrected in time. The trailer may push the tractor until the cab hits the trailer.

Rollover

More than half of truck driver deaths in crashes are the result of truck rollovers. When more cargo is piled up in a truck, the "center of gravity" moves higher up from the road. The truck becomes easier to turn over. Fully loaded rigs are ten times more likely to roll over in a crash than empty rigs.

The following two things will help you prevent rollover--keep the cargo as close to the ground as possible and drive slowly around turns. Keeping cargo low is even more important in combination vehicles than in straight trucks. Also, keep the load centered on your rig. If the load is to one side so it makes a trailer lean, a rollover is more likely. Make sure your cargo is centered and spread out as much as possible ([NV CDL Section 3](#)).

Rollovers happen when you turn too fast. Drive slowly around corners, on ramps, and off ramps. Avoid quick lane changes, especially when fully loaded ([Nevada Commercial Driver License Manual, pg. 6-1](#)).

Slippery Surfaces

It will take longer to stop, and it will be harder to turn without skidding, when the road is slippery. Wet roads can double stopping distance. You must drive slower to be able to stop in the same distances on a dry road. Reduce speed by about one third (e.g., slow from 55 to 35 mph) on a wet road. On packed snow, reduce speed by half, or more. If the surface is icy, reduce speed to a crawl and stop driving as soon as you can safely do so.

Identifying Slippery Surfaces

Sometimes it is hard to know if the road is slippery. Here are some signs of slippery roads.

- 1) **Shaded areas.** Shady parts of the road will remain icy and slippery long after open areas have melted.
- 2) **Bridges.** When the temperature drops, bridges will freeze before the road will. Be especially careful when the temperature is close to 32 degrees Fahrenheit or lower.
- 3) **Melting ice.** Melting ice is much more slippery than ice that is not wet.
- 4) **Black ice.** Black ice is a thin layer that is clear enough that you can see the road underneath it. It makes the road look wet. Any time the temperature is below freezing and the road looks wet, watch out for black ice.
- 5) **Vehicle icing.** An easy way to check for ice is to open the window and feel the front of the mirror, mirror support, or antenna. If there's ice on these, the road surface is probably starting to ice up.
- 6) **Just after rain begins.** Right after it starts to rain, the water mixes with oil left on the road by vehicles. This makes the road very slippery.

Brake Failure

Brakes kept in good condition rarely fail. Most hydraulic brake failures occur for one of two

reasons: Loss of hydraulic pressure and brake fade on long hills ([Nevada Commercial Driver Manual](#), pg. 2-34).

If you lose air/hydraulic pressure:

- 1) Pump the brakes (for hydraulic brakes only);
- 2) Down-shift;
- 3) Pump the brakes;
- 4) Use the parking brake;
- 5) Use an escape ramp; and
- 6) If no escape ramp is available, take the least hazardous escape route you can—such as an open field or a side road that flattens out or turns uphill.

Proper Braking Technique

When driving downhill, snub braking is an effective braking technique. You need to select a safe speed, which is a speed that does not exceed the speed limit, is not too fast for the weight of the vehicle, length, and steepness of the grade, weather, and road conditions. Once you reach your safe speed, brake down gently to 5 mph below your safe speed. Brake for a firm 3-4 seconds followed by a gradual cooling. Continue this procedure while driving downhill to maintain your safe speed ([Nevada Commercial Driver Manual](#), pg. 5-9).

**If you have tire failure, do not brake until after
you have gained control of the bus!**

Tire Failure

It is important that you recognize tire failure quickly because you only have a few seconds to react. If your front tire has a blowout, your bus will pull in the direction of the flat. If your rear tire blows out, the bus will swerve violently. Here is how to recognize tire failure ([Nevada Commercial Driver Manual](#), pg. 2-34).

- 1) **Sound.** The loud bang of a blowout is an easily recognized sign. Because it can take a few seconds for your vehicle to react, you might think it is some other vehicle. But any time you hear a tire blow, you must assume it is yours and prepare to stop.
- 2) **Vibration.** If the vehicle thumps or vibrates heavily, it may be a sign that one of the tires has gone flat. With a rear tire, that may be the only sign you get.
- 3) **Feel.** If the steering feels heavy, it is probably a sign that one of the front tires has failed. Sometimes, failure of a rear tire will cause the vehicle to slide back and forth or fishtail. However, dual rear tires usually prevent this.
- 4) If you believe that one of your tires has had a blowout, you need to:
 - a) **Hold the steering wheel firmly.** If a front tire fails, it can twist the steering wheel out

of your hand. The only way to prevent this is to keep a firm grip on the steering wheel with both hands at all times.

- b) **Stay off the brake.** It's natural to want to brake in an emergency. However, braking when a tire has failed could cause you to lose of control.
- c) Once you have regained control, use steady braking, making sure to not lock up the wheels.
- d) Move off the roadway as far as possible and secure the bus.
- e) Notify your dispatcher and evacuate the bus if necessary.

School bus drivers must always plan for emergencies. That is why school buses are equipped with emergency equipment and exit doors and windows. You will need to know what emergency equipment is on the school bus, where it is located and how it is used. In addition, you will need to know procedures when an emergency occurs.

Hydroplaning

In some weather, water or slush collects on the road. When this happens, your vehicle can hydroplane ([Nevada Commercial Driver License Manual](#), pg. 2-14). It's like water skiing; the tires lose their contact with the road and have little or no traction. You may not be able to steer or brake. You can regain control by releasing the accelerator. This will slow your vehicle and let the wheels turn freely.

- 1) If the vehicle is hydroplaning, **DO NOT USE THE BRAKES TO SLOW DOWN!**
- 2) It does not take a lot of water to cause hydroplaning. Hydroplaning can occur at speeds as low as 30 mph if there is a lot of water. Hydroplaning is more likely if tire pressure is low.
- 3) Road surfaces where water can collect can create conditions that cause a vehicle to hydroplane. Watch for clear reflections, tire splashes, and raindrops on the road. These are indications of standing water.

Defensive Driving

Steering to Avoid a Crash

Following safe driving practices can prevent emergencies, but if an emergency does happen, your chances of avoiding a crash depend upon how well you take action.

Stopping is not always the safest thing to do in an emergency. When you don't have enough room to stop, you may need to steer away from what's ahead. Remember, you can almost always turn to miss an obstacle more quickly than you can stop ([Nevada Commercial Driver Manual](#), pg. 2-33).

- 1) **Keep both hands on the steering wheel.** In order to turn quickly you must have a firm grip on the steering wheel with both hands. The best way to have both hands on the wheel in the event of an emergency is to keep them there all the time.
- 2) **Know how to turn quickly and safely.** A quick turn can be made safely if it is done the

right way. Here are some points that safe drivers use.

- a) **Do not apply the brake** while you are turning. It is very easy to lock your wheels while turning. If that happens, you may skid out of control.
- b) **Do not turn any more than needed** to clear whatever is in your way. The more sharply you turn, the greater the chances of a skid or rollover.
- c) **Be prepared to counter-steer**, that is, to turn the wheel back in the other direction, once you have passed whatever was in your path. Unless you are prepared to counter-steer, you won't be able to do it quickly enough. You should think of emergency steering and counter-steering as two parts of one driving action.

**If you have to steer to avoid crash, DON'T
BRAKE!**

- 3) **Know where to steer.** If an oncoming driver has drifted into your lane, moving to the right is best. If that driver realizes what has happened, the natural response will be to return to his or her own lane.
- 4) If something is blocking your path, the best direction to steer will depend on the situation.
 - a) If you have been using your mirrors, you'll know which lane is empty and can be safely used.
 - b) If the shoulder is clear, going right may be best. No one is likely to be driving on the shoulder, but someone may be passing you on the left. You will know if you have been using your mirrors.
 - c) If you are blocked on both sides, a move to the right may be best. At least you won't force anyone into an opposing traffic lane and a possible head-on collision.
- 5) **Leaving the road.** In some emergencies, you may have to drive off the road. It may be less risky than facing a collision with another vehicle.
- 6) Most shoulders are strong enough to support the weight of a large vehicle and, therefore, may offer an available escape route. Here are some guidelines to follow if you do leave the road.
 - d) **Avoid braking.** If possible, avoid using the brakes until your speed has dropped to about 20 mph. Then brake very gently to avoid skidding on a loose surface.
 - e) **Keep one set of wheels on the pavement** if possible. This will help maintain control.
 - f) **Stay on the shoulder.** If the shoulder is clear, stay on it until your vehicle has come to a stop.
- 7) **Returning to the road.** If you are forced to return to the road before you can stop, do the following:
 - g) **Hold the wheel tightly and turn enough to get right back on the road safely.** Try to edge gradually back on the road. If you do, your tires might grab unexpectedly and

you could lose control.

- h) When both front tires are on the paved surface, counter steer immediately. The two turns should be made as a single steer- counter steer move.

Stopping Quickly and Safely

If someone suddenly pulls out in front of you, your natural response is to hit the brakes. This is a good response if there is enough distance to stop and you use the brakes correctly.

You should brake in a way that will keep your vehicle in a straight line and allow you to turn if it becomes necessary. You can use either the controlled braking or the emergency stab braking method ([Nevada Commercial Driver Manual](#), pg. 2-34).

- 1) **Controlled braking.** Apply the brakes as hard as you can without locking the wheels. Keep steering wheel movements very small while doing this. If the wheels lock, release the brakes. Re-apply the brakes as soon as you can.
- 2) **Emergency stab braking**
 - a) Apply your brakes all the way.
 - b) Release the brakes when wheels lock up.
 - c) Once the wheels start rolling, apply the brakes fully again. It can take up to one second for the wheels to start rolling after you release the brakes. If you re-apply the brakes before the wheels start rolling, the vehicle won't straighten out.
 - d) Hold the wheel tightly and turn enough to get right back on the road safely. Try to edge gradually back on the road. If you don't, your tires might grab unexpectedly, and you could lose control.
 - e) Do not jam the brakes. Emergency braking does not mean pushing down on the brake pedal as hard as you can. That will only keep the wheels locked up and cause a skid. If the wheels are skidding, you cannot control the vehicle.

Unit 1.3.3 Railroad-Highway Grade Crossing

This unit must teach driver-trainees to recognize potential dangers and appropriate safety procedures to utilize at railroad (RR)-highway grade crossings. This instruction must include an overview of various Federal/State RR grade crossing regulations, RR grade crossing environments, obstructed view conditions, clearance around the tracks, and rail signs and signals. The training providers must instruct driver-trainees that railroads have personnel available (“Emergency Notification Systems”) to receive notification of any information relating to an unsafe condition at the RR-highway grade crossing or a disabled vehicle or other obstruction blocking a railroad track at the RR-highway grade crossing.

Railroad Crossings

In 2021 there were 2,131 highway-rail grade crossing collisions, 237 fatalities and 653 injuries ([Operation Lifesaver Data](#)).

Signs and Signals at Railroad Crossings

- 1) **Passive and active traffic control** signs. These devices are installed along the roads near the railroad tracks to regulate, warn and guide traffic. They alert you to the presence of railroad tracks and to the possibility of an approaching train. Below is a list of various signs and devices that you will see in connection with a highway-rail grade crossing.
- 2) The **Crossbuck** sign is the most common sign at public highway-rail intersections. It has two crossed white boards with words railroad crossing. It marks the crossing.
 - a) If there is more than one track, a sign below the cross buck indicates the number of tracks present.
 - b) School buses must stop before the crossbuck sign.
 - c) After a train has passed, wait, look, and listen for another train coming from either direction. Take care at passive crossings.

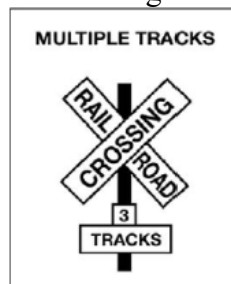

- 3) The **stop** and **yield** sign means the same as they do at highway intersections. A driver must always stop at the STOP sign in advance of the railroad track.

School bus drivers are required to STOP at railroad crossings when transporting student.

[Nevada Revised Statue 484B.560](#)

- 4) The **do not stop on the tracks** sign reminds the driver not to stop on the railroad track for any reason.



- 5) The **tracks out of service** sign tells the driver trains no longer travel these tracks. It is not necessary to stop at these crossings.



- 6) The **exempt** crossing sign placed below the cross buck informs drivers of school buses carrying children that a stop is not required by law, **except** when a train is approaching or occupying the crossing. Because these tracks can be activated and trains could be on the tracks, it is recommended that exempt stops be evaluated, and school bus drivers use extreme caution when approaching **exempt** crossings. Some school districts may require school buses stop at exempt crossings.

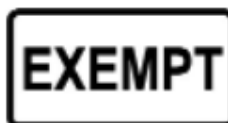

- 7) **Signs in advance** of railroad crossings warn drivers that the road crosses the railroad tracks ahead.
- 8) Yellow circular **advance warning** sign warns drivers that the road crosses railroad tracks ahead.



- 9) **Pavement markings** on paved roads near the yellow circular Advance Warning sign also alert drivers that the road crosses railroad tracks ahead.



- a) A **stop line** may be painted across the lane on paved roads and identifies the safe place to stop while looking and listening for an approaching train.
- b) The driver must stop the school bus before the Stop Line. On gravel roads there are no pavement markings or stop lines. If there are no Stop Line, you must stop the school bus within 50 feet but not less than 15 feet from the nearest rail ([Nevada Revised Statute 484B.553](#)).
- c) The Stop Line on each side of a single track grade crossing are at least 35 feet apart. Do not stop within this area.
- d) Drivers should remember to apply the emergency or parking brakes while waiting at the Stop Line, so they won't move or be shoved into the path of the train.

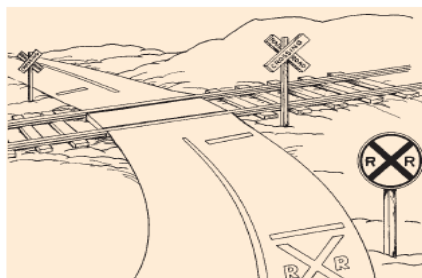

- 10) The **yellow diamond parallel track** sign identifies highway-rail grade crossings that appear immediately after making either a right or a left turn ([OLS Bus Driver's Guide](#)).



Active Signal Devices at Railroad Crossings

There are electronically powered devices that warn of an approaching train.

- 1) **Flashing red lights**, with or without bells-warn of an approaching train. When the red lights are flashing, a train is approaching. You must stop and wait until the train passes, the gates go up and the lights go out, and then proceed when it is clearly safe to do so.
- 2) Flashing red lights, with bells and gates-warn that a train is approaching. It is illegal to go around lowered gates ([Operation Lifesaver Instructors Guide](#)).

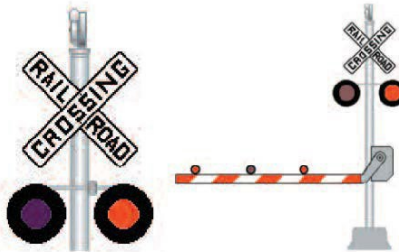

- 3) **Emergency notification** sign shows the railroad's emergency phone number and USDOT Crossing Number. Each crossing in the USA has a unique USDOT Crossing Number. If it is missing call 911.



- 4) When you are not required to stop at a railroad crossing ([Federal Motor Carrier Safety Regulation 392.10](#) and [Nevada Revised Statute 484B.560](#)).
 - a) When you are not carrying students on the school bus.
 - b) When a police officer or official traffic-control device controls the movement of traffic.
 - c) When the crossing that is marked with a device indicating that the crossing is abandoned or exempt.

NEVER attempt to race a train to a crossing. It is easy to misjudge a train's speed and distance, making it appear to be moving more slowly than it actually is.

Requirements to Practice Emergency Evacuation Drills

- 1) At least twice each year, all students who ride the school bus must practice the evacuation of a school bus and receive instruction in the responsibility of a passenger on a school bus to use the emergency exit doors on the school bus, including helping passengers evacuate the school bus in an emergency ([NRS 386.820 Section 1](#)).
- 2) Each school district shall adopt a safety program in accordance with [NRS 386.820 Section 2](#).
- 3) You must practice and participate in emergency evacuations at the beginning of any field trip ([Nevada Revised Statute 386.820](#) and [National Transportation Safety Board Safety Recommendation, Oakland, Iowa](#)).

Evacuation Procedures

Be prepared and plan ahead. When possible, assign two responsible, older student assistants to each emergency exit. Teach them how to assist other students to get off the bus and how to use emergency exits and equipment. If an emergency evacuation is required, you must scan your surroundings and check for traffic in front and behind you. Know the safest location to take your students in event of a crisis at any crossing on your route.

- 1) Plan how you would evacuate your bus to a safe place as far away from the railroad tracks at least 100 feet off the road in the direction of an oncoming train.
- 2) Place transmission in Park, set the parking brake and shut the engine off.
- 3) Remove the ignition key and activate the hazard-warning lights;
- 4) Order the evacuation and get the students off the bus quickly to a safe place. Make sure to walk through the bus to ensure no students remain on the bus. Retrieve emergency equipment.
- 5) If necessary, call 911. Notify dispatch of evacuation location, conditions, and type of assistance needed. Use the emergency notification number posted at or near the crossing to notify them that you're stalled on the tracks and call 911.
- 6) Account for all students and check for their safety.
- 7) Protect the scene and set out emergency warning devices ([Nevada Commercial Driver License Manual](#), pg. 10-7).

Special Situations at Railroad Crossings

- 1) **Bus stalls or trapped on tracks.** If your school bus stalls or is trapped on the tracks, get everyone out and off the bus and tracks immediately. Move everyone far from the bus at

an angle, which is both away from the tracks and toward the train.

- 2) **Police officer at the crossing.** If a police officer is at the crossing, obey directions. If there is no police officer, and you believe the signal is malfunctioning, call your dispatcher to report the situation and ask for instructions on how to proceed.
- 3) **Obstructed view of tracks.** Do not attempt to cross the tracks unless you can see far enough down the track to know for certain that no trains are approaching.
- 4) **Passive crossings.** Are those that do not have any type of traffic control device. Be especially careful at “passive” crossings. Even if there are active railroad signals that indicate the tracks are clear, you must look and listen to be sure it is safe to proceed.
- 5) **Containment or storage areas.** If it won't fit, don't commit! Each driver needs to know the length of their bus and the size of the storage or containment area at the highway-rail crossings on your school bus route, as well as any crossing you encounter in the course of a school activity trip.
 - a) When approaching a crossing with a signal or stop sign on the opposite side, pay attention to the amount of room there. Be certain the bus has enough containment or storage area to completely clear the railroad tracks on the other side if there is a need to stop. As a general rule, add 15 feet to the length of the school bus to determine an acceptable amount of containment or storage area ([Nevada Commercial Driver License Manual](#), pg. 10-9).
 - b) Watch your overhang. Know the length of your vehicle and allow for your vehicle's overhang as well. While the wheels of the bus may have crossed the track, many drivers don't realize that their back end could still be hanging over the tracks. Many times, a crash could be avoided if it weren't for the last few feet ([Operation Lifesaver Instructor Guide](#)).



Mandatory Emergency Evacuations at Railroad Crossings

You are required to evacuate the school bus when:

- Your school bus is stalled on or adjacent to a railroad crossing; or

- The position of the bus may change and increase danger ([Nevada Commercial Driver L Manual](#), pg. 10-6).

Section 1.4 Vehicle Systems and Reporting Malfunctions

This unit must provide entry-level driver-trainees with sufficient knowledge of the CMV and its systems and subsystems to ensure that they understand and respect their role in vehicle inspection, operation, and maintenance and the impact of those factors upon highway safety and operational efficiency.

Unit 1.4.1 Identification and Diagnosis of Malfunctions

This unit must teach driver-trainees to identify major vehicle systems. The goal is to explain their function and how to check all key vehicle systems, as appropriate (e.g., engine, engine exhaust auxiliary systems, brakes, drive train, coupling systems, and suspension) to ensure their safe operation. Driver-trainees must be provided with a detailed description of each system, its importance to safe and efficient operation, and what is needed to keep the system in good operating condition.

Major vehicle systems and malfunctions

Accelerator/brake pedal. Accelerator pedal is on the right and makes the vehicle go. Brake pedal is on the left and stops the vehicle. Check that it is connected and functional.

Air brakes. Uses compressed air to make the brakes work. With the engine running, build the air pressure to 120-140 PSI. Shut the engine off and push in the parking brake, press on the foot brake, and hold it for 1 minute. Check the air gauge to see if the air pressure drops not more than 3 PSI in 1 minute. With the key in the on position, begin applying and releasing the foot brake. The low air warning device should activate before the air pressure drops below 60 PSI. Continue to apply and release the foot brake, at approximately 40 PSI, the parking brake should pop out.

Air compressor belt/gear. With the engine off, driver points to air compressor. Mention that the compressor is securely mounted and not leaking. Identifies the belt that drives air compressor. With engine off, driver points to, touches, or presses the belt to test that it is snug. Notes that the belt is not frayed, has no visible cracks, loose fibers, or signs of wear. Pushes belt with hand, and if it deflects more than $\frac{1}{2}$ to $\frac{3}{4}$ of an inch, driver observes that slippage is probably excessive.

Air gauge. Check that the air gauge is working properly and that the air compressor builds the air pressure to governor cut-out at roughly 120-140 PSI.

Air leaks/level. Air brake and suspension systems. Be sure that the vehicle is sitting level (front and rear), and if air-equipped, check for audible air leaks from air brake system or suspension system air bags.

Alternator belt/gear. With engine off, points to or touches alternator. Mentions the alternator is securely mounted and that all wires are securely fastened. Identifies belt that drives alternator or generator. With engine off, points to, touches, or presses belt to see that the belt is snug. Notes that the belt is not frayed, has no visible cracks, loose fibers, or signs of wear. Pushes belt with hand and if it deflects more than $\frac{1}{2}$ to $\frac{3}{4}$ of an inch, driver observes that slippage is probably excessive.

Ammeter/voltmeter. Indicate if alternator is properly functioning. Driver checks that the gauge

shows that the alternator or generator is charging, and the warning light is off. Needle will jump and flutter, then indicate charged. Voltmeter needs to be within normal operating range which is 12- 14 volts and the ammeter should be above zero.

Anti-lock brake systems (ABS). Prevents brakes from locking up. When starting your engine ABS light should go on and off, you should hear “popping noises” this is an automatic checking system on each tire. If you do not hear any popping noises, the ABS could be defective. If the ABS is defective, braking will default back to the regular braking system.

Axle seals. Make sure there are no cracks or distortions in wheel/axle mounting and there are no signs of leaking lubricants. If the axle has a sight glass, driver checks that oil level is adequate.

Battery box. Wherever located, see that the batteries are secure, connections are tight, and cell caps are present. Battery connections should not show signs of excessive corrosion. Battery box and cover or door must be secure.

Brake chambers. See that brake chambers are not leaking, cracked, or dented and are mounted securely. All mounting hardware is present and secure.

Brake drum/linings. Brake shoes and linings rub on the inside of the drum to slow the vehicle down. Check for cracks, dents, or holes. Also check for loose or missing bolts. Brake linings (where visible) are no thinner than ¼ inch. Check brake drum and linings for contaminants such as grease, oil, etc.

Brake Hoses/Lines. Check that the hoses/lines can supply air or hydraulic fluid to brakes. Check for cracked, worn or frayed hoses, and that all couplings are secure and not leaking.

Clutch/gearshift. Disengages engine from drive train so vehicle won't move and reduces load on starting motor. Depress clutch before turning on the starter. Keep it depressed until the engine reaches idling speed. On an automatic transmission, place the gear selector in the park or neutral position. On a standard transmission, place gearshift in neutral. Start engine and release the clutch slowly.

Coolant level. Look at sight glass of reservoir, or if the engine is not hot, remove the radiator cap and look to see the level. Adequate level will show in sight glass or be visible in the radiator when the cap is removed. **Note:** If the engine is hot, do not remove the radiator cap.

Crossing control arm. Check to make sure that it activates with red loading lights and retracts back to bumper fully. Driver may not, at any time, tie the crossing arm to the bus preventing it from extending out. The crossing arm must always be operational, or bus is Out-of-Service, except for special needs buses which are used solely to transport special needs students who are manually loaded and unloaded.

Doors/hinges. Check that driver and passenger entry, exit, rear, and side doors are not damaged and that they open, close and latch properly from the inside. Check door window for damage and excessive dirt. Hinges should be secure with seals intact. Check that all emergency exits are clearly labeled and working correctly.

Driveshaft. Visually and physically inspect each segment of the driveshaft and association hardware. Inspect for bends, cracks, missing weights, or debris entangled in the shaft. Each shaft

more than 18 inches long shall be equipped with a suitable guard to prevent an accident or injury in the event of its fracture of disconnection, bent or missing.

Visually and physically inspect each universal joint and center bearing. The universal joint(s) and center bearing(s) shall not be loose or worn and shall have all attaching hardware securely fastened. Check for lateral and vertical movement of the universal joints and center bearing by grasping the universal joint and attempting to move it. Check for welded repairs ([National Transportation Specifications and Procedures, 2015](#), pg. 86).

Driver's seat/seat belt. Must be secured to floor and driver seat belt is not frayed, securely mounted, adjusts and latches properly.

Emergency equipment. Check for three red reflective triangles, fire extinguisher, first-aid kit, body-fluid clean up kit and spare fuses (if used). All emergency equipment must be readily accessible to the driver and clearly labeled.

Emergency exits. Make sure that the bus is equipped with the required number of emergency exits, emergency exits are not damaged, operate smoothly, and open and close securely from the inside and outside of the school bus. Check that all emergency exit-warning devices are working and are properly identified. Check that the flip seat at any emergency exit can remain in the upright position when not in use has no obstructions and the safety mechanism is operational. Student restraint systems cannot be placed next to an emergency exit.

Exhaust system. Check system for damage and signs of leaks such as rust or carbon soot. System should be connected tightly and mounted securely.

Fire extinguisher. Fire extinguisher must be fully charged, properly rated, sealed, pin in place and a current certification tag. The fire extinguisher must be secured and readily accessible to the driver.

Frame. Check that there are no cracks and frame members are not bent. No loose, cracked, bent, broken, or missing cross members. Cracks are most likely to appear midway between points of attachment to vehicle assemblies. Check that floors are not damaged.

Fuel tank. Check that tank(s) are securely mounted with mounting straps, caps are tight and there are no leaks from tank(s) or lines. Signs of spillage from overfilling a fuel tank are not to be treated as a fuel leak. Fuel tank guard, if equipped, is securely mounted.

Glow plug/indicator light. The key should be turned to the "on" position and the driver should wait until the glow plug indicator goes out before starting the engine.

Heater/defroster. Test that heater and defroster work.

Horn. Check that horn works.

Hub oil seal. Checks that wheel hub oil seal on the front axle is not leaking. If a sight glass is present, visibly check that oil level is adequate.

Hydraulic brakes. On buses without airbrakes, pump brake pedal 3 times and hold down for 5 seconds. Brake pedal should not move (depress) during this time. If equipped with a hydraulic brake reserve (back-up system), with the key off, press the brake pedal and listen for the sound of the reserve system electric motor. Check that the warning buzzer or light is off.

Leaks/hoses. Look for puddles or dripping fluids on the ground, under the engine or the underside of the engine and transmission. Inspect engine hoses for condition and leaks.

Lighting indicators. Check dash indicators to make sure both left- and right-hand turn signals, 4-way flashers, headlight high beams, and fog/driving lights illuminate when corresponding lights are turned on.

Lights/reflectors. Check that all outside lights and reflective equipment is clean and functional and lenses are not cracked, broken, or missing. This includes clearance lights (red on rear and amber elsewhere), headlights (both high and low beams), taillights, turn signals, four-way flashers, brake lights, red reflectors (on rear) and amber reflectors (elsewhere), strobe light (if equipped), stop arm light and alternately flashing amber and red lights. You must check the brake, turn signal and four-way flashers functions operate separately.

Lug nuts. Check that all lug nuts are present, are not loose (look for rust trails around nuts), have no cracks radiating from lug bolt holes, or distortion of the bolt holes.

Mirrors (All). Inspect side mirrors and passenger entry/exit mirrors. Check for proper adjustment during in-cab inspection. Check that all internal and external mirrors and mirror brackets are not damaged cracked, broken and are mounted securely with no loose fittings. Check to assure that visibility is not impaired due to dirty mirrors.

Oil level. Check oil level before starting the engine. Be able to indicate where dipstick is located. Check that oil level is above the refill mark and in a safe operating range.

Oil pressure gauge. Check that the oil pressure is building to normal. The gauge shows increasing/decreasing oil pressure or warning light goes off. Engine oil temperature gauge (if present) should begin a gradual rise to normal operating range.

Parking/maxi brake. Check that the parking brake will hold the vehicle by gently trying to pull forward with the parking brake on.

Passenger entry. Check that the entry door is not damaged, operates smoothly, and closes securely. Check that handrails are secure, and the step light is working. Check that entry steps are clear, the tread is secure and not worn excessively.

Passenger seats. Check that there are no broken seat frames and that the frames are firmly attached to floor. Seat cushions must be attached securely to the seat frame and cannot be damaged.

Power steering fluid. With the engine stopped, check the dipstick, and see where the fluid level is. Level must be above refill mark.

Power steering pump (belt or gear). With the engine off, driver must point to, touch, or press belt to test that it is snug. Note that the belt is not frayed, has no visible cracks, loose fibers, or signs of wear. Push belt with hand, and if it deflects more than 1/2 to 3/4 of an inch, slippage is probably excessive. Need to know and mention if pump is belt driven or gear driven. If device is gear driven, must be able to know of the belt/gear is operating properly, is not damaged or leaking, and is properly mounted and secure.

Rims. Tires are mounted on rims or bare metal. Check for damaged or bent rims. Rims cannot have any non-manufactured welds. Check for rust trails that may indicate rim is loose on hub.

Shock absorbers. Check that shock absorbers are secure and that there are no leaks. Be prepared to inspect the same suspension components on every axle.

Slack adjuster. Check for broken, loose, or missing parts. With brakes released, when pulled by hand push rod should not move more than approximately 1 inch. Check that mounting hardware is present and not damaged or missing.

Spacers. If equipped, check that spacers are not bent, damaged, or rusted through. Check that spacers are evenly centered, with the dual wheels and tires evenly separated. Note: If vehicle is not equipped with spacers, driver must mention this and check between the discs (Budd) wheels for even spacing, damage and foreign objects.

Splash guards. Check that splashguards or mud flaps are not damaged and are mounted securely.

Spring/air/torque. Look for missing, shifted, cracked or broken leaf springs. Look for broken or distorted coil springs. If vehicle is equipped with torsion bars, torque arms or other types of suspension components, check that they are not damaged and are mounted securely. Check air ride suspension for damage and leaks.

Spring mount. Check that spring attachments (brackets, bolts, bushings) are in place. Check for cracked or broken spring hangers. Check for broken, missing, or loose bolts (including U-bolts). Check for missing or damaged bushings. Check for broken, lose or missing axle mounting parts.

Steering box/hoses. Check that the steering box is securely mounted and not leaking. Look for any missing nuts, bolts, and cotter pins. Check for power steering fluid leaks or damage to power steering hoses.

Steering linkage. Check that connecting drag link, pitman arm, tie rod and upper and lower steer arms from the steering box to the wheel are not worn or cracked. Check that joints and socket are not worn or loose. Check for loose or missing nuts, bolts, or cotter pins.

Steering play. Turn steering wheel back and forth and see that there should not be more than 10 degrees (approximately 2 inches movement at the rim of a 20-inch steering wheel).

Stop arms. Check the stop arm to see that it is mounted securely to the frame of the vehicle. Check for loose fittings and damage. Check that the stop arm extends fully when operated and stop arm lights are operational.

Temperature gauge. Measures coolant temperature in the engine cooling system. Make sure the temperature gauge is working. Temperature should begin to climb to the normal operating range or temperature light should be off.

Tires. Check every tire for the following ([Nevada Commercial Driver License Manual](#), pg. 11-4):

- 1) No recaps on the front tires.
- 2) Bias and radial tires have not been combined.
- 3) Check minimum tread depth (4/32" on steering axle tires, 2/32" on all other tires).
- 4) Check tire condition. Tread is evenly worn and look for cuts or other damage to tread or sidewalls. Also, make sure that valve caps and stem are not missing, broken, or damaged.
- 5) Check for proper inflation.

Water pump/belt. With the engine off, point to, touch, or press the belt to test that it is snug. Note that the belt is not frayed, has no visible cracks, loose fibers, or signs of wear. Push the belt with hand, and if it deflects more than 3/4 of an inch, slippage is likely and belt needs tightened. Drivers should know and mention if pump is belt driven or gear driven. Water pump appears to be functioning, properly mounted and secure and not leaking.

Wheelchair lift/tie downs. Check for leaking, damaged or missing parts and explain how it should be checked for correct operation. Check that doors and hinges are not damaged and that they open, close, and latch properly. Check that wheelchair ties are secure. Wheelchair lift must be fully retracted and latched securely.

Windshield. Check the windshield to make sure it is clear, clean and has no illegal stickers, obstructions, or damage to the glass. Windshield cannot obstruct the drivers view.

Wipers/washers. Check that wiper arms and blades are secure, not damaged and operates smoothly. Check for windshield washer fluid and that windshield washers operate correctly.

Inspection Items for Other CMVs Electrical

- 1) Check that trailer connectors are sealed and in good condition.
- 2) Check fittings out of truck and trailer.
- 3) Check all connections from truck and trailer.
- 4) Check that glad hands are locked in place and free of damage.
- 5) Check that trailer electrical plug is firmly seated and locked in place on both truck and trailer.

Catwalk and Steps

- 1) Check that catwalk is solid, securely bolted to tractor frame, and clear of loose objects.
- 2) Check that the steps are solid securely bolted to the tractor frame, and clear of loose objects.

Cargo

- 1) Check that doors and hinges are not damaged and that they open, close, and latch properly.
- 2) Check that ties, straps, chains, and binders are secure.
- 3) If equipped with cargo lift, check for leaking, damaged, or missing parts and explain how to check for correct operation.
- 4) Check that lift is fully retracted and latched securely.

Locking Pins

If equipped, check that the locking pins are locked in place and release arm is secured.

Header Boards and Bulkheads

- 1) If equipped, check header board or bulkhead to see that it is secure, free of damage, and strong enough to contain cargo.
- 2) On enclosed trailers, check the front area for signs of damage (i.e., cracks, bulges, holes, or missing rivets).

Hitch and Trailer

- 1) Check to see that hitch release lever is in place and secure.
- 2) Check that kingpin is not bent or damaged.
- 3) Check that visible part of apron is not bent, cracked, or damaged.
- 4) Check that the trailer is laying flat on the fifth wheel skid plate and that there is no space between the apron and fifth wheel (no gap).
- 5) Check that landing gear is fully raised, has no missing parts, crank handle is secure, and the support frame and landing pads are not damaged.
- 6) If power operated, check for air or hydraulic leaks.
- 7) Check locking mechanism for missing or broken parts and security.
- 8) Check that fifth wheel locking jaws or lever are secure around the king pin.
- 9) Check for loose or missing brackets, clamps, bolts, or nuts.
- 10) Check that fifth wheel and sliding mounting appear solidly attached in place.
- 11) Check for loose or missing mounting bolts and for broken welds for pintle hook or other type of hitch mount, and tongue/draw-bar assembly, to ensure that they are solidly attached in place.
- 12) Check the pintle hook for cracks or breaks and excessive wear.
- 13) Check for cracks or breaks in the platform structure, which supports the fifth wheel, skid plate.
- 14) Check that the release arm is secure and all the way in.
- 15) If equipped with safety latch, check that the release arm is in the engaged position and the safety latch is in place.
- 16) Check to make sure the latch is secured and locked in place, cotter pin is not missing, is in place and not damaged.
- 17) Safety chains are hooked and crisscrossed, free of kinks and excessive slack, cotter pins to hooks are in place and hooks are secured with hooks pointing in an outward position.
- 18) If trailer is equipped with electric brakes, check that breakaway chains or cables with battery backup are not missing or damaged.
- 19) If equipped, look for loose or missing pins in the slide mechanism of the sliding fifth wheel. If air powered, check for leaks.
- 20) Make sure locking pins are fully engaged.
- 21) Check that the fifth wheel is positioned properly so the tractor frame will clear the landing gear during turns.
- 22) If equipped, check that the sliding pintle is secured with no loose or missing nuts or bolts and cotter pin is in place.
- 23) Check that the tongue/draw-bar is not bent or twisted and check for broken welds and stress cracks.
- 24) Check that the tongue/draw-bar eye is not worn excessively.

- 25) Check that the storage area is solid and secure to the tongue; cargo in the storage area i.e., chains, binders etc., are secure.

Unit 1.4.2. Roadside Inspections

This unit must instruct driver-trainees on what to expect during a standard roadside inspection conducted by authorized personnel. The training providers must teach driver-trainees on what vehicle and driver violations are classified as out-of-service (OOS), including the ramifications and penalties for operating a CMV when subject to an OOS order as defined in [section 390.5](#).

What to Expect at a Roadside Inspection

You will be greeted by the inspector/officer, and they will ask you to shut the truck off. You may even be asked to remove your keys from the ignition. Your wheels will be chocked, and they will ask you to release your brakes.

You will be asked for your logbook/log device and credentials, and they will ask basic questions. The inspection (Level 1) will start, and you will be given more instructions.

It is important that you follow instructions. If you cannot hear the inspector/officer, just ask for them to repeat what they want. Failure to follow instructions can get someone injured and will cause the inspection to go poorly for you.

Be organized to speed things up. Inspections have procedures that must be followed and there's no way to make that process shorter. But you can make it go smoother (and therefore faster) if you get yourself organized.

Common Violations for Drivers

- 1) Log is not current
- 2) 15-hour Rule violation
- 3) False or Forged Logbook
- 4) Form and Matter violations regarding the formatting of the log

Common Violations on Vehicles

- 1) Tires
- 2) Load securement
- 3) Lighting
- 4) Leaks
- 5) Damaged windshield
- 6) No proof of annual inspection



Ramifications of operating a CMV when subject to an OOS order

Out-of-Service order means a declaration by an authorized enforcement officer of a Federal, State, Canadian, Mexican, or local jurisdiction that a driver, a commercial motor vehicle, or a motor carrier operation is out-of-service pursuant to [49 CFR 386.72](#), [392.5](#), [392.9a](#), [395.13](#), or [396.9](#), or compatible laws, or the North American Standard Out-of-Service Criteria. Table from [49 CFR 383.51\(a\)](#):

If the driver operates a CMV and is convicted of ***	For a first conviction while operating a CMV, a person required to have a CLP or CDL and a CLP or CDL holder must be disqualified from operating a CMV for ***	For a second conviction in a separate incident within a 10-year period while operating a CMV, a person required to have a CLP or CDL and a CLP or CDL holder must be disqualified from operating a CMV for ***	For a third or subsequent conviction in a separate incident within a 10-year period while operating a CMV, a person required to have a CLP or CDL and a CLP or CDL holder must be disqualified from operating a CMV for ***
(1) Violating a driver or vehicle out-of-service order while transporting nonhazardous materials	No less than 180 days or more than 1 year	No less than 2 years or more than 5 years	No less than 3 years or more than 5 years.
(2) Violating a driver or vehicle out-of-service order while transporting hazardous materials as defined in § 383.5 , or while operating a vehicle designed to transport 16 or more passengers, including the driver	No less than 180 days or more than 2 years	No less than 3 years or more than 5 years	No less than 3 years or more than 5 years.

Driver Out-Of-Service Regulations

School bus drivers can be placed out-of-service by their employer, law enforcement or inspectors. You will be placed out-of-service for any of the following violations:

- 1) Any driver who does not possess a valid CDL, including, but not limited to improper class, expired, cancelled, revoked, disqualified, suspended, or withdrawn ([Federal Motor Carrier Safety Regulation 391.15, Disqualification of Drivers](#)).
- 2) Any driver with a learner's permit who is not accompanied by the holder of a valid CDL. Must also hold a valid automobile driver license or have a valid operator's status allowed by licensing jurisdiction ([Federal Motor Carrier Safety Regulation 383.25, Commercial Learner's Permit](#)).
- 3) Any driver operating a school bus without corrective lenses or hearing aid as indicated on the driver's medical certificate ([Federal Motor Carrier Safety Regulation 391.11, General Qualifications of Drivers](#)).
- 4) Any driver operating a school bus without possessing a valid medical certificate ([Federal Motor Carrier Safety Regulation 391.41, Physical Qualification for Drivers](#)).
- 5) When a driver's ability or alertness is so impaired, or so likely to become impaired, through fatigue, illness, or any other cause that is likely to make it unsafe for him/her to begin or continue to operate CMV ([Federal Motor Carrier Safety Regulation 392.3, Ill or Fatigued Operator](#)).
- 6) Any driver who violates Hours of Service laws:
 - a) Any driver who has driven more than 10 hours in a 15 hour period;
 - b) Any driver who has been on duty for 15 hours ([Nevada Revised Statute 386.815](#));
 - c) Any driver who has been on duty for more than 60 hours in 7 consecutive days;
 - d) Has no record of duty status (logbook) when required; or
 - e) Provides a false record of duty status (logbook) ([Federal Motor Carrier Safety Regulation 395.8, Driver's Record of Duty Status](#)).

Note: When a driver at the direction of the motor carrier is traveling, but has no direct responsibility to the carrier, the time is counted as on-duty time unless the driver is afforded at least 10 consecutive hour's off-duty when arriving at the destination. In this case the driver is off duty for the entire period ([Federal Motor Carrier Safety Regulation, 395.1 \(j\)](#)).

Drivers who are traveling with the bus must count that time as on-duty.

Unit 1.4.3 Maintenance

This unit must introduce driver-trainees to the basic servicing and checking procedures for various engine and vehicle components and to help develop their ability to perform preventive maintenance and simple emergency repairs.

State School Bus Inspections

Following the passage of Assembly Bill (AB) 417 (2021), school buses must be inspected annually by the Commercial Vehicle Enforcement (CMV) division of the Nevada Highway Patrol. If a bus is placed out of service based on that annual inspection, there will need to be another inspection conducted after appropriate repairs are made before the bus can be used again. As a school bus driver, if you can catch any of these issues throughout the year it will save everyone time and money as well as increase the efficiency of your department by allowing for more proactive identification of possible concerns. The details of what to look for and how to conduct school bus inspections are in Unit 1.1.3 pre- and post-inspections. This section is dedicated to CMV systems and reporting in general.

Major Vehicle Systems

- 1) **Engine** – the component that provides power for the vehicle.
- 2) **Engine Exhaust** – collects the exhaust gases from the cylinders, removes harmful substances, reduces the level of noise, and discharges the purified exhaust gases at a suitable point of the vehicle away from its occupants.
- 3) **Brakes** – a device for slowing or stopping a moving vehicle.
- 4) **Drive Train** – connects the transmission to the drive axles.
- 5) **Suspension** – the system of springs and shock absorbers by which a vehicle is cushioned from road conditions.
- 6) **Coupling Systems**- the primary connection component in a towing system that attaches a trailer to your tow vehicle.
- 7) **Fifth Wheel Hitch** – the part that lives in the bed of the pickup truck or on the top of the frame of a semi-truck that is a large, flat plate that has a shape similar to a horseshoe.
- 8) **Pintle Hitch** – a type of tow hitch that uses a ring-to-hook for a more secure mount that's ideal for rougher terrain.
- 9) **Ball Coupling** – a type of tow hitch that uses a ball coupling as a mount.

Simple Emergency Repairs

Flat Tire – Note the location of the flat tire and contact your mechanic for instructions. Depending on the location of the flat tire, you may be able to continue driving the vehicle for a short distance.

Overheating – Leave the engine running and turn on all heaters until the temperature gauge is within normal range.

Fluid Leaks – Note the color and location of where the fluids are leaking from and contact your

mechanic for instructions.

Running out of fuel – Note the type of fuel that is being used and contact your mechanic for instructions.

Dead Battery - Depending on the reason your battery is dead; you may just need a “jump”, or you may need to have the vehicle towed. Contact your mechanic.

Section 1.5 Non-Driving Activities

This section must teach driver-trainees activities that do not involve actually operating the CMV, e.g., proper cargo securement.

Unit 1.5.1 Handling and Documenting Cargo

This unit must teach driver-trainees the basic theory of cargo weight distribution, cargo securement on the vehicle, cargo covering, and techniques for safe and efficient loading/unloading. The training providers must also teach driver-trainees the basic cargo security/cargo theft prevention procedures. The training providers must teach driver-trainees the basic information regarding the proper handling and documentation of HM cargo.

Safety handling

If you load cargo wrong or do not secure it, it can be a danger to others and yourself. Loose cargo that falls off a vehicle can cause traffic problems and others could be hurt or killed. Loose cargo could hurt or kill you during a quick stop or crash. Your vehicle could be damaged by an overload. Steering could be affected by how a vehicle is loaded, making it more difficult to control the vehicle. Whether or not you load and secure the cargo yourself, you are responsible for inspecting your cargo, recognizing overloads and poorly balanced weight, knowing your cargo is properly secured and does not obscure your view ahead or to the sides, and knowing your cargo does not restrict your access to emergency equipment. If you intend to carry hazardous material that requires placards on your vehicle, you will also need to have a hazardous materials endorsement ([Nevada CDL Manual pg. 3-1](#)).

Legal Weight Limits

You must keep weights within legal limits. States have maximums for GVWRs, GCWRs, and axle weights. Often, maximum axle weights are set by a bridge formula. A bridge formula permits less maximum axle weight for axles that are closer together. This is to prevent overloading bridges and roadways. Overloading can have bad effects on steering, braking, and speed control. Overloaded trucks have to go very slowly on upgrades. Worse, they may gain too much speed on downgrades. Stopping distance increases. Brakes can fail when forced to work too hard. During bad weather or in mountains, it may not be safe to operate at legal maximum weights. Take this into account before driving ([Nevada CDL Manual pg. 3-1](#)).

Don't Be Top-heavy

The height of the vehicle's center of gravity is very important for safe handling. A high center of gravity (cargo piled up high or heavy cargo on top) means you are more likely to tip over. It is most dangerous in curves, or if you have to swerve to avoid a hazard. It is very important to distribute the cargo so it is as low as possible. Put the heaviest parts of the cargo under the lightest parts ([Nevada CDL Manual pg. 3-2](#)).

Balance the Weight

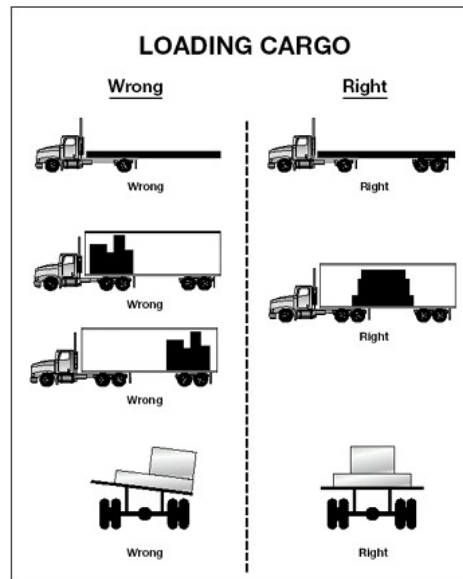

Poor weight balance can make vehicle handling unsafe. Too much weight on the steering axle can cause hard steering. It can damage the steering axle and tires. Under-loaded front axles (caused by shifting weight too far to the rear) can make the steering axle weight too light to steer safely. Too little weight on the driving axles can cause poor traction. The drive wheels may spin easily. During bad weather, the truck may not be able to keep going. Weight that is loaded so there is a high center of gravity causes greater chance of rollover. On flat bed vehicles, there is also a greater chance that the load will shift to the side or fall off ([Nevada CDL Manual pg. 3-2](#)).

Blocking and Bracing

Blocking is used in the front, back, and/or sides of a piece of cargo to keep it from sliding. Blocking is shaped to fit snugly against cargo. It is secured to the cargo deck to prevent cargo movement. Bracing is also used to prevent movement of cargo. Bracing goes from the upper part of the cargo to the floor and/or walls of the cargo compartment ([Nevada CDL Manual pg. 3-2](#)).

Cargo Tie-down

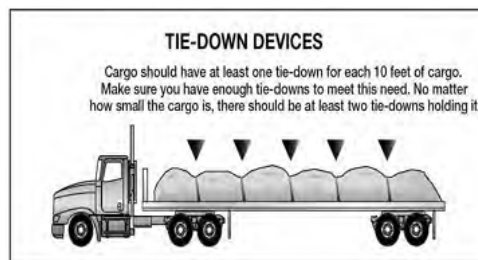

On flatbed trailers or trailers without sides, cargo must be secured to keep it from shifting or falling off. In closed vans, tie-downs can also be important to prevent cargo shifting that may affect the handling of the vehicle. Tie-downs must be of the proper type and proper strength. Federal regulations require the aggregate working load limit of any securement system used to secure an

article or group of articles against movement must be at least one-half times the weight of the article or group of articles. Proper tie-down equipment must be used, including ropes, straps, chains, and tensioning devices (winches, ratchets, clinching components). Tie-downs must be attached to the vehicle correctly (hooks, bolts, rails, rings) ([Nevada CDL Manual pg. 3- 2](#)).

Covering Cargo

There are two basic reasons for covering cargo: To protect people from spilled cargo. To protect the cargo from weather. Spill protection is a safety requirement in many states. Be familiar with the laws in the states you drive in. You should look at your cargo covers in the mirrors from time to time while driving. A flapping cover can tear loose, uncovering the cargo, and possibly block your view or someone else's ([Nevada CDL Manual pg. 3-3](#)).

Basic cargo security and theft prevention

- 1) Use high-security locks
- 2) Communicate consistently with dispatch
- 3) Keep your cell with you when away from the vehicle
- 4) Be aware of high theft areas and avoid hot spots of theft
- 5) Keep moving to reduce risk of theft
- 6) Park in secure locations
- 7) Use tracking devices

Documentation of HM

Shipping paper requirements are contained in 49 CFR Part 172 Subpart C. For the purpose of the hazardous materials regulations, a shipping paper is any shipping document whose purpose is to communicate a hazard and conforms to the requirements contained in this Subpart. Each person who offers hazardous materials for transportation shall describe the hazardous materials on a shipping paper that conforms to the requirements of the HMR. No carrier may transport a hazardous material unless it is accompanied by a shipping paper that is prepared in accordance with the HMR.

The regulation requires an emergency response telephone number to be placed on the shipping paper. The telephone number must be monitored at all times when the material is in transportation to include storage incidental to transportation. The number must be of a person who is knowledgeable of the hazardous materials being shipped and the appropriate emergency response procedures, or a person who has immediate access to a person who has such knowledge.

Emergency Response Information

- The Emergency response telephone number must be monitored at all times while the shipment is in transit.
- Emergency response information that must appear on the shipping paper or in a separate document with the shipping paper:
 - Description of the hazmat material contained

- The potential immediate hazards to health
- Directions to handle small or large fires, spills, or leaks
- Preliminary first aid measures

For more information visit [FMCSA *How to comply with Hazardous Materials Regulations*](#)

Unit 1.5.2 Environmental Compliance Issues

This unit must teach driver-trainees to recognize environmental hazards and issues related to the CMV and load, and also make aware that city, county, State, and Federal requirements may apply to such circumstances.

Class	Class Name	Example
1	Explosives	Ammunition, Dynamite, Fireworks
2	Gases	Propane, Oxygen, Helium
3	Flammable	Gasoline, Acetone
4	Flammable Solids	Matches, Fuses
5	Oxidizers	Ammonium Nitrate, Hydrogen Peroxide
6	Poisons	Pesticides, Arsenic
7	Radioactive	Uranium, Plutonium
8	Corrosives	Hydrochloric Acid, Battery Fluid
9	Miscellaneous Hazardous Material	Materials Formaldehyde, Asbestos
10	ORM-D (Other Regulated Material-Domestic)	Hair Spray or Charcoal
11	Combustible Liquids	Fuel Oils, Lighter Fluid

Responses to Specific Hazards

Class 1 (Explosives)

If your vehicle has a breakdown or accident while carrying explosives, warn others of the danger. Keep bystanders away. Do not allow smoking or open fire near the vehicle. If there is a fire, warn every one of the dangers of a possible explosion.

Remove all explosives before separating vehicles involved in a collision by placing the explosives at least 200 feet from the vehicles and occupied buildings and keep a safe distance.

Class 2 (Compressed Gases)

If compressed gas is leaking from your vehicle, warn others of the danger. Only permit those involved in removing the hazard or wreckage to get close. You must notify the shipper if compressed gas is involved in any accident. Unless you are fueling machinery used in road construction or maintenance, do not transfer a flammable compressed gas from one tank to another on any public roadway.

Class 3 (Flammable Liquids)

If you are transporting a flammable liquid and have an accident or your vehicle breaks down, prevent bystanders from gathering. Warn people of the danger. Keep them from smoking. Never transport a leaking cargo tank farther than needed to reach a safe place. Get off the roadway if you can do so safely. Don't transfer flammable liquid from one vehicle to another on a public roadway except in an emergency.

Class 4 (Flammable Solids) and Class 5 (Oxidizing Materials)

If a flammable solid or oxidizing material spills, warn others of the fire hazard. Do not open smoldering packages of flammable solids. Remove them from the vehicle if you can safely do so. Also, remove unbroken packages if it will decrease the fire hazard.

Class 6 (Poisonous Materials and Infectious Substances)

It is your job to protect yourself, other people, and property from harm. Remember that many products classed as poison are also flammable. If you think a Division 2.3 (Poison Gases) or Division 6.1 (Poison Materials) might be flammable, take the added precautions needed for flammable liquids or gases. Do not allow smoking, open flame, or welding. Warn others of the hazards of fire, of inhaling vapors, or coming in contact with the poison. A vehicle involved in a leak of Division 2.3 (Poison Gases) or Division 6.1 (Poisons) must be checked for stray poison before being used again. If a Division 6.2 (Infectious Substances) package is damaged in handling or transportation, you should immediately contact your supervisor. Packages that appear to be damaged or show signs of leakage should not be accepted

Class 7 (Radioactive Materials)

If radioactive material is involved in a leak or broken package, tell your dispatcher or supervisor as soon as possible. If there is a spill, or if an internal container might be damaged, do not touch or inhale the material.

Do not use the vehicle until it is cleaned and checked with a survey meter.

Class 8 (Corrosive Materials)

If corrosives spill or leak during transportation, be careful to avoid further damage or injury when handling the containers. Parts of the vehicle exposed to a corrosive liquid must be thoroughly washed with water. After unloading, wash out the interior as soon as possible before reloading. If continuing to transport a leaking tank would be unsafe, get off the road. If safe to do so, contain any liquid leaking from the vehicle. Keep bystanders away from the liquid and its fumes. Do everything possible to prevent injury to bystanders.

CHEMTREC (800) 424-9300

The Chemical Transportation Emergency Center (CHEMTREC) in Washington also has a 24-hour toll-free line.

CHEMTREC was created to provide emergency personnel with technical information about the physical properties of hazardous materials. The National Response Center and CHEMTREC are

in close communication. If you call either one, they will tell the other about the problem when appropriate.

Do not leave radioactive yellow - II or yellow - III labeled packages near people, animals, or film.

You or your employer must phone CHEMTREC when any of the following occur as a direct result of a hazardous materials incident:

- 1) A person is killed.
- 2) An injured person requires hospitalization. Estimated property damage exceeds \$50K.
- 3) The general public is evacuated for more than one hour.
- 4) One or more major transportation arteries or facilities are closed for one hour or more.
- 5) Fire, breakage, spillage, or suspected radioactive contamination occurs.
- 6) Fire, breakage, spillage, or suspected radioactive contamination occurs involving shipment of infectious substances,
- 7) The release of a marine pollutant in a quantity greater than 119 gallons or a liquid or 882 pounds for a solid.

Unit 1.5.3 Hours of Service Requirements

This unit must teach driver-trainees to understand that there are different hours-of-service (HOS) requirements applicable to different industries. The training providers must teach driver-trainees all applicable HOS regulatory requirements. The training providers must teach driver-trainees to complete a Driver's Daily Log (electronic and paper), timesheet, and logbook recap, as appropriate. The training providers must teach driver-trainees the consequences (safety, legal, and personal) of violating the HOS regulations, including the fines and penalties imposed for these types of violations.

PROPERTY-CARRYING DRIVERS	PASSENGER-CARRYING DRIVERS
11-Hour Driving Limit May drive a maximum of 11 hours after 10 consecutive hours off duty.	10-Hour Driving Limit May drive a maximum of 10 hours after 8 consecutive hours off duty.
14-Hour Limit May not drive beyond the 14th consecutive hour after coming on duty, following 10 consecutive hours off duty. Off-duty time does not extend the 14-hour period.	15-Hour Limit May not drive after having been on duty for 15 hours, following 8 consecutive hours off duty. Off-duty time is not included in the 15-hour period.
Rest Breaks May drive only if 8 hours or less have passed since end of driver's last off-duty or sleeper berth period of at least 30 minutes. Does not apply to drivers using either of the short-haul exceptions in 395.1(e). [49 CFR 397.5 mandatory "in attendance" time may be included in break if no other duties performed]	60/70-Hour Limit May not drive after 60/70 hours on duty in 7/8 consecutive days.
60/70-Hour Limit May not drive after 60/70 hours on duty in 7/8 consecutive days. A driver may restart a 7/8 consecutive day period after taking 34 or more consecutive hours off duty.	Sleeper Berth Provision Drivers using a sleeper berth must take at least 8 hours in the sleeper berth, and may split the sleeper berth time into two periods provided neither is less than 2 hours.
Sleeper Berth Provision Drivers using the sleeper berth provision must take at least 8 consecutive hours in the sleeper berth, plus a separate 2 consecutive hours either in the sleeper berth, off duty, or any combination of the two.	

On-Duty Time and Hours-Of-Service Regulations

When transporting students to extra-curricular activities, it is important for you to know hours of service regulations and what on-duty time means.

On-Duty Time Includes

All the time from the time a driver begins to work or is required to be in readiness to work until the time the driver is relieved from work and all responsibility for performing work and includes:

- 1) All time spent at a facility waiting to be dispatched;
- 2) All time inspecting, servicing, or conditioning any school bus;
- 3) All time spent driving a school bus;

- 4) All time spent on the school bus, other than driving time;
- 5) All time needed for loading and unloading, supervising, or assisting the loading and unloading of students, and anytime waiting for students;
- 6) All time used for repairing, obtaining assistance, or waiting for assistance to repair a disabled vehicle;
- 7) All time spent being tested for drugs and alcohol, including travel time to and from the collection site;
- 8) Performing any other work as a common, contracted, or private motor carrier; and
- 9) Performing any work for a non-motor carrier ([Federal Motor Carrier Safety Regulation 395, Hours of Service](#)).

You are required by federal law to include all duties performed for which you were compensated by any employer.

What is Not Considered On-Duty Time

- 1) Time spent resting in a parked vehicle;
- 2) Time spent resting in a hotel;
- 3) When relieved of all duty and responsibility for the care and custody of the vehicle or passengers it is carrying.
- 4) Any rest break of at least 30 minutes as off-duty time provided:
 - a) The driver is relieved of all duty and responsibility for the care and custody of the vehicle, its accessories, and any cargo or passengers it may be carrying; and
 - b) During the stop, and for the duration of the stop, the driver must be at liberty to pursue activities of his/her own choosing.

Nevada hours-of-service regulations exceed federal hours-of- service regulations. In Nevada you must follow the below regulations.

- 1) Cannot operate a vehicle or school bus for more than 10 hours in a 15-hour period.
- 2) After driving 10 hours and/or operating a vehicle in a 15-hour period, you must rest (be off-duty) for 10-hours ([Nevada Revised Statute 386.815](#)).
- 3) Drivers who drive extra-curricular activity trips that travel out of state should keep a logbook showing on-duty time ([Federal Motor Carrier Safety Regulation 395.8, Driver's Record of Duty Status](#)).
- 4) Drivers who encounter adverse driving conditions and who cannot, because of these conditions, safety completely the run within the maximum driving time are permitted to

drive for not more than 2 additional hours ([Federal Motor Carrier Safety Regulation 395.1, Scope of Rules in this Part](#)).

Drivers who are traveling with the bus must count that time as on-duty.

Electronic Logging Device (ELD):

Q: Who must comply with the electronic logging device (ELD) rule?

A: The ELD rule applies to motor carriers and drivers who are currently required to keep records of duty service (RODS) under the hours-of-service (HOS) regulations.

Drivers who use the timecard exception, and don't keep paper RODS, will not be required to use ELDs.

The following drivers may keep paper RODS:

- Drivers who keep RODS no more than 8 days during any 30-day period.
- Driveaway-towaway drivers (transporting a vehicle for sale, lease, or repair), provided the vehicle driven is part of the shipment or the vehicle being transported is a motor home or recreational vehicle trailer.
- Drivers of vehicles manufactured before model year 2000.
- However, a carrier can choose to use an ELD, even if it is not required.

Unit 1.5.4 Fatigue and Wellness Awareness

The issues and consequences of chronic and acute driver fatigue and the importance of staying alert will be covered in this unit. The training providers must teach driver-trainees about wellness and basic health maintenance information that affect a driver's ability to safely operate a CMV.

Basic Health Maintenance

Basic health Maintenance that affects a driver's ability to safely operate a motor vehicle include mental and physical conditions. Mental wellness can include alertness which can be weakened by fatigue, and burnout. Physical conditions can include hunger, dehydration, posture.

Mental Wellness

An alert driver is responsive and aware to hazards and road conditions. An alert driver can respond quickly. Fatigue can lower a driver's alertness creating unsafe conditions. Like all other jobs drivers are prone to burnout. To avoid burnout, maintain healthy levels of sleep, diet, and exercise. Cultivate your ability to self-reflect and attend to your needs.

Fatigue

Fatigue causes errors related to speed and distance, increases your risk of being in a crash, causes you to not see and react to hazards as quickly; and affects your ability to make critical decisions.

- 1) Drowsy driving is one of the leading causes of traffic collisions. NHTSA estimates 100,000 police-reported crashes a year.
- 2) According to the National Sleep Foundations Sleep in America Poll, 60% of Americans have driven while feeling sleepy and more than 103 million people admit having actually fallen asleep at the wheel.
- 3) If you are sleepy, the only safe cure is to get off the road and get some sleep.

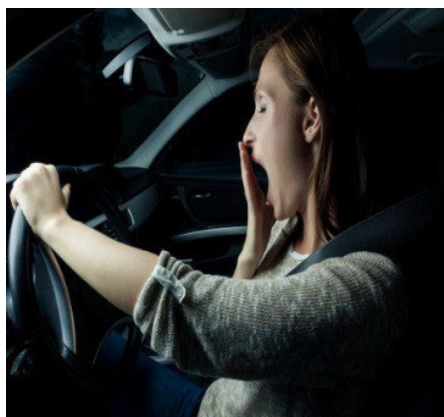

At-risk groups. Crashes tend to occur at times when sleepiness is most common, like during the night and in the mid-afternoon. Most people are less alert at night, especially after midnight ([Nevada Commercial Driver Manual](#), pg. 2-25).

Research has identified young males, shift workers, commercial drivers, and people with untreated sleep disorders or with short-term chronic sleep deprivation as having an increased risk for having a crash resulting from falling asleep at the wheel.

NTSB has reported that drowsy driving was the cause of more than half of crashes leading to a death.

According to the National Sleep Foundation's Sleep in America poll, 60% of Americans have driven while feeling sleepy and 36% admit falling asleep at the wheel in the past year.

[Nevada Commercial Driver Manual](#), (pg. 2-25)

Warning signs of fatigue. Many people cannot tell if or when they are about to fall asleep ([Nevada Commercial Driver Manual](#), pg. 2-25). There are warning signs that indicate fatigue:

- 1) Difficulty focusing, frequent blinking or heavy eyelids;
- 2) Yawning repeatedly or rubbing eyes;
- 3) Daydreaming or wandering/disconnected thoughts;
- 4) Trouble remembering the last few miles driven, missing exits or traffic signs;
- 5) Trouble keeping head up;
- 6) Drifting from your lane, following too closely, or hitting a shoulder rumble strip; and
- 7) Feeling restless and irritable.

Physical Wellness

Staying hydrated is important to maintaining your health. Consistent hydration is necessary to expel metabolic waste and toxins from your system. You should drink plenty of water daily to stay energized and alert. Exercise regularly by stretching or walking after a long day behind the wheel to help maintain posture. Avoid slouching, your spine needs to relieve pressure and you should adjust your position every 30 minutes to avoid feeling stiff.

Unit 1.5.5 Post-Crash Procedures

This unit must teach driver-trainees the appropriate post-crash procedures, including the requirement that the driver, if possible, assess his or her physical condition immediately after the crash and notify authorities, or assign the task to other individuals at the crash scene. The training providers must teach driver-trainees how to protect the area; obtain emergency medical assistance; move on-road vehicles off the road in minor crashes so as to avoid subsequent crashes or injuries; engage flashers; place reflective triangles and other warning devices for stopped vehicles; and properly use a fire extinguisher, if necessary. The training providers must instruct driver-trainees in post-crash testing requirements related to controlled substances and alcohol.

Crash Procedures

If you are in crash, follow these procedures:

- 1) Stop the vehicle and if in a major crash do not move it without permission of the investigating officer. If the crash was minor where there were slight damage to the vehicles involved that does not impede their ability to operate safely and there are no injuries move on-road vehicles off the road to avoid subsequent crashes or injuries. Never leave the scene of the accident;
- 2) Assess your physical condition immediately and determine that you can perform emergency functions. If not assign the following tasks to another individual at the crash scene.
- 3) Set the brake, turn off ignition and activate hazard lights;
- 4) Notify dispatch of crash location, conditions, and type of assistance needed;
- 5) Call 911 for emergency assistance;
- 6) Remain calm and survey the scene;
- 7) Account for all passengers and assess the situation;
- 8) Secure the scene;
- 9) Evacuate the vehicle if necessary;
- 10) Take the keys and place emergency warning devices;
- 11) If on a bus collect the names of students and establish a seating chart; Law enforcement officials will require a seating chart at the time of the crash;
- 12) Do not discuss the crash; and
- 13) Do not release any of your students unless authorized.

**Any statement you make about a crash can be used in court.
Do not discuss causes of the crash with other involved.
Do not admit guilt and let the proper authorities handle the case.**

Warning Devices

Warning devices such as flares or reflective triangles should be positioned properly to warn other drivers of an accident.

- **The first device** should be positioned in the direction of approaching traffic, within 10 feet of the last vehicle involved in the accident, and on the traffic side. No flame-producing signal should ever be attached to any part of a truck or another vehicle!
- **A second device** should be placed about 100 feet *behind* the accident scene, facing approaching traffic, and in the center of the lane or shoulder where the truck and other vehicles involved in the accident are stopped.
- **The third device** should be placed about 100 feet in *front* of the accident scene and facing traffic approaching from the other direction.

Fire extinguisher

To operate a fire extinguisher, remember the word PASS:

Pull the pin. Hold the extinguisher with the nozzle pointing away from you and release the locking mechanism.

Aim low. Point the extinguisher at the base of the fire.

Squeeze the lever slowly and evenly.

Sweep the nozzle from side-to-side.

You should only use the fire extinguisher:

- 1) Once you have evacuated all students to a safe place;
- 2) The fire is small and contained to a single object; and
- 3) You are safe from the toxic smoke produced by the fire. Do not use the fire extinguisher:
 - If the fire is spreading beyond the spot where it started;
 - If you can't fight the fire with your back to an escape exit; and

If the fire can block your only escape.

A fire extinguisher may not put a fire out, but it will provide you with valuable time to get students off the bus!

Post-Accident Required Testing Criteria.

Under FMCSA regulation [Title 49 CFR 382.209](#) no driver required to take a post-accident alcohol test shall consume alcohol for eight hours following the accident, or until he/she undergoes a post-

accident test, whichever occurs first. A test is required in multiple situations.

- 1) A test must always be conducted on a surviving driver when an accident involving a CMV results in a fatality. The driver does not need to be cited for a traffic violation or be deemed at fault for this test to occur.
- 2) If the driver is in an accident where at least one vehicle is towed AND the driver receives a citation for a moving traffic violation.
- 3) If the driver is in an accident where at least one person received medical treatment away from the scene AND the driver receives a citation for a moving traffic violation.

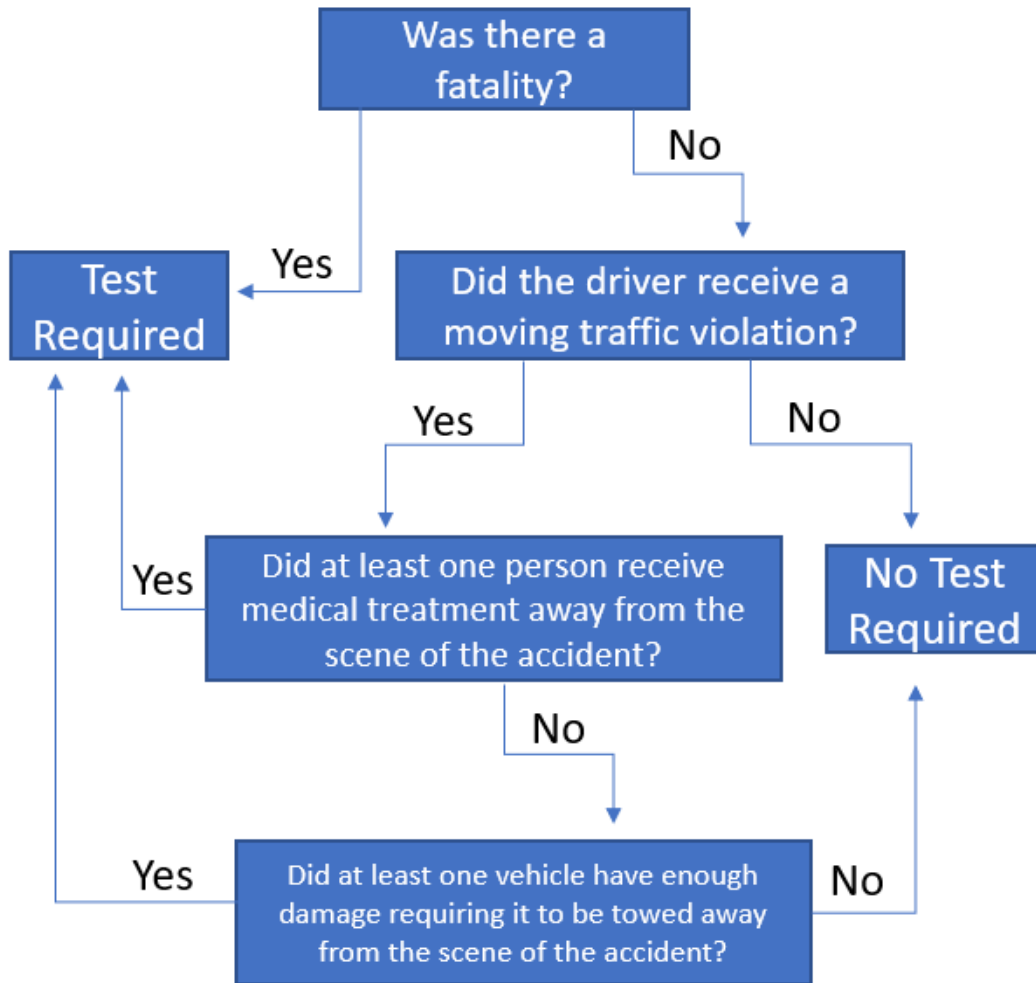

Unit 1.5.6 External Communications

This unit must instruct driver-trainees in the value of effective interpersonal communication techniques/skills to interact with enforcement officials. The training providers must teach driver-trainees the specifics of the roadside vehicle inspection process, and what to expect during this activity. Driver-trainees who are not native English speakers must be instructed in FMCSA English language proficiency requirements and the consequences for violations. The training providers must teach driver-trainees the implications of violating Federal and state regulations will have on their driving records and their employing motor carrier's records.

Specifics of the roadside vehicle inspection process

You will be greeted by the inspector/officer.

They will ask you to shut the truck off. You may even be asked to remove your keys from the ignition.

Your wheels will be chocked.

They will ask you to release your brakes.

You will be asked for your logbook/log device and credentials, and they will ask basic questions.

The inspection (a level 1) will start, and you will be given more instructions.

It's important that you follow instructions. If you can't hear the inspector/officer, just ask for them to repeat what they want. Failure to follow instructions can get someone injured and will cause the inspection to go poorly for you.

Be organized to speed things up.

Inspections have procedures that must be followed and there's no way to make that process shorter. But you can make it go smoother (and therefore faster) if you get yourself organized.

Here's a basic list:

- Do you know your dashboard? Know how to work the many systems of your vehicle. It's amazing how many don't know where all of the controls are.
- Make sure you know where your logbook is or have a plan for the inspector to look at your electronic log. Know how to access your elogs and how to email them to the inspector.
- Organize your permits. Recommend to drivers to go through they're permit book at least once a quarter and know what's in there. Rifling through permits alone adds 5 to 10 minutes (or more) alone onto the inspection time.

English Language Proficiency

English language proficiency is required under the FMCSA regulations. [FMCSA 49 CFR 391.11\(b\)\(2\)](#) states "a person is qualified to drive a motor vehicle if he/she - Can read and speak the English language sufficiently to converse with the general public, to understand highway traffic signs and signals in the English language, to respond to official inquiries, and to make entries on reports and records."

Ways You Communicate

Interpersonal Communication

Interpersonal communication is communication between two or more people. During your roadside inspection the process can go more smoothly if you communicate effectively.

Verbal and Non-Verbal Messages

Verbal messages should be professional. You should speak politely and directly to speed up the process. Nonverbal messages such as logs and should be written clearly. Being organized and ready with documents can communicate your efficiency and understanding of what is required.

Attitude

Remain professional. This is a procedure and a being argumentative can slow down the process. It can also communicate hostility which can turn in become dangerous.

Failure to communicate effectively can result in a failed inspection. Not having proper documents can put you and your vehicle out of service. This can result in delayed shipments and loss of time. Violations can even disqualify your license.

Effects on driving record

Records are verified by employer yearly and can affect your employment.

Unit 1.5.7 Whistleblower/Coercion

This unit must teach the driver-trainees about the right of an employee to question the safety practices of an employer without incurring the risk of losing a job or being subject to reprisals simply for stating a safety concern. The training providers must instruct driver-trainees in the whistleblower protection regulations in [29 CFR part 1978](#). The training providers must teach driver-trainees the procedures for reporting to FMCSA incidents of coercion from motor carriers, shippers, receivers, or transportation intermediaries.

Coercion

Coercion occurs when a motor carrier, shipper, receiver, or transportation intermediary threatens to withhold work from, take employment action against, or punish a driver for refusing to operate in violation of certain provisions of the Federal Motor Carrier Safety Regulations (FMCSRs), Hazardous Materials Regulations (HMRs) and the Federal Motor Carrier Commercial Regulations (FMCCRs).

Coercion may be found to have taken place even if a violation has not occurred.

An example of coercion is when a motor carrier terminates a driver for refusing to accept a load that would require the driver to violate the hours of service requirements.

Elements of Coercion

The following must have occurred for coercion to have existed:

- A motor carrier, shipper, receiver, or transportation intermediary request a driver to perform a task that would result in the driver violating certain provisions of the FMCSRs, HMRs, or the FMCCRs;
- The driver informs the motor carrier, shipper, receiver, or transportation intermediary of the violation that would occur if the task is performed, such as driving over the hours of service limits or creating unsafe driving conditions; and
- The motor carrier shipper, receiver, or transportation intermediary make a threat or take action against the driver's employment or work opportunities to get the driver to take the load despite the regulatory violation that would occur.

Coercion Complaints

Coercion complaints must be filed within 90 days of the alleged coercion action.

When filing your complaint, please include as much supporting information as you have, such as:

- Text messages or email exchanges between parties showing coercion attempts by a motor carrier, shipper, receiver, or transportation intermediary, as well as your responses; and
- Names of anyone who may have witnessed the coercion attempt.
- All coercion complaints must be in writing and can be mailed to the Division Office located in the state where the complainant is employed or filed with the National Consumer Complaint Database.

Whistleblowers

File a Whistleblower Complaint with the Occupational Safety and Health Administration (OSHA)

Drivers have the right to question the safety practices of their employer without the risk of losing their job or being subject to retaliation for stating a safety concern. The Occupational Safety and Health Administration's whistleblower statutes protect drivers from retaliation.

<https://www.whistleblowers.gov/>

Protections

Under [29 CFR part 1978](#) it outlines protections and ramifications for employers that retaliate against an employee.

Employers are in violation if they intimidate, threaten, restrain, coerce, blacklist, discharge, discipline, harass, suspend, demote, or in any other manner retaliate against any employee that has testified or will testify, made an oral or filed a written complaint with an employer, government agency or others for violation of motor vehicle safety, or security regulation, standard or order. If an employee feels they have been retaliated against for a complaint made they may file a complaint with the local OSHA. Addresses and telephone numbers for these officials are set forth in local directories and at the following Internet address: <http://www.osha.gov>.

Unit 1.5.8 Trip Planning

This unit must address the importance of and requirements for planning routes and trips. This instruction must address planning the safest route, planning for rest stops, heavy traffic areas, railroad-highway grade crossing safe clearance and ground clearance (*i.e.*, “high center”), the importance of Federal and State requirements on the need for permits, and vehicle size and weight limitations. The training providers must teach driver-trainees the correct identification of restricted routes, the pros and cons of Global Positioning System (GPS)/trip routing software, and the importance of selecting fuel-efficient routes.

Planning the route

In general, this is more applicable to long haul drivers. Short haul drivers such as a school bus driver routes are often set and require a little adjustment. When planning a route, you are given a destination and you figure out how many miles there. You need to consider how much your fuel your vehicle can hold and how many miles you can travel with a tank of fuel. Managing fatigue is a consideration and you need to plan for rests. You want to plan hours of the day that works for you and that you can make stops where there are amenities that work for you. The interstate highway system is often the safe route but not always the most fuel efficient. As fuel is one of the largest expenses in driving use tools like GPS to plan for rest stops on the shortest and most reasonable route.

Planning for rest stops

You need to constantly need to plan and adjust. Knowing your allowed driving time and an average of 55 mph you can determine how long your travel will take and when you will need to stop to stay within compliance of hours of service.

Using GPS to plan routes

Using tools like GPS, apple and google maps is a great tool to plan the route. It will give you estimated route information and stops along the way. With detailed information for turn-by-turn directions. The downside to using these is times upon planning may show traffic in real time and by time you drive your route it may be better or worse. Some roads may not be updated in real time due to construction changes. It is also good to remember that when they estimate time it is based on non CMV posted speed limits which is not always applicable to CMV drivers. You should plan to travel 600-650 miles in a given day. A good recommendation is to add 25% travel time when traveling heavy or through mountains. GPS may also plot routes that are restricted from CMVs. Be mindful when routes are crossing bridges and railroads of clearance.

Heavy traffic areas

Cities, border crossings, ports are heavy traffic areas. It is good to plan your timing for routes in heavy traffic areas during lower congestion times. Congestion is heavier typically during hours in which people go to or from work.

Railroad-highway grade crossing safe clearance

FMCSA prohibits drivers subject to the Department of Transportation's commercial vehicle safety rules from entering a highway-rail grade crossing unless there is enough space to drive completely through the crossing without stopping. The prohibition is included in [Part 392 of FMCSA's Federal Motor Carrier Safety Regulations](#) and [Part 174 of PHMSA's Hazardous Materials Regulations](#). The new Federal prohibition is intended to improve safety and includes significant consequences for violations, and disqualification of CDL holders who are convicted of violating State traffic laws prohibiting this unsafe driving behavior. The Federal Railroad Administration (FRA) has developed a Rail Crossing Locator application (app) that allows users to access the highway-rail grade crossing database and map features on an iPhone or iPad using a free App available through Apple's App Store.

FRA's Rail Crossing Locator app works by prompting users to enter a specific location, which then allows them to locate highway-rail grade crossings in their area and retrieve important information, such as the physical characteristics of a crossing and the type of traffic control devices used. The app also allows users to report information about grade crossings to the FRA to ensure the most accurate and up-to-date information is available.

Federal requirements for permits and vehicle size and weight limitations

Federal law prevents States from enforcing vehicle weight limits on Interstate highways that deviate from established Federal weight limits and specific exceptions. Although most States explicitly establish two sets of weight limits, one for State highways and one for Interstate highways, others do not explicitly draw out separate limits for Interstates in statute. The Federal government does not issue permits for oversize or overweight vehicles. This is a State option.

The driver must be mindful of permits required and weight limits for each state in which they are operating in. A list of states permitting offices contacts can be found at the [Department of Transportation website for freight management and operations](#).

Unit 1.5.9 Drugs/Alcohol

This unit must teach driver-trainees the rules applicable to controlled substances (including prescription drugs) and alcohol use and testing related to the operation of a CMV.

Use during operation of a CMV

A driver cannot take a controlled substance or prescription medication without a prescription from a licensed practitioner. If a driver uses a drug identified in [21 CFR 1308.11 \(391.42\(b\)\(12\)\)](#) or any other substance such as amphetamine, a narcotic, or any other habit forming drug, The driver is medically unqualified.

There is an exception: the prescribing doctor can write that the driver is safe to be a commercial driver while taking the medication. In this case, the Medical Examiner may, but does not have to certify the driver.

Any anti-seizure medication used for the prevention of seizures is disqualifying.

The Medical Examiner has 2 ways to determine if any medication a driver uses will adversely affect safe operation of a CMV:

- Review each medication - prescription, non-prescription and supplement
- Request a letter from the prescribing doctor

Alcohol use is always prohibited while operating any motor vehicle.

Controlled Substances And Alcohol Use Testing

Required Testing

The United State Department of Transportation has published "[What Employees Need to Know About DOT Alcohol & Drug Testing](#)" as a reference for testing procedures and frequently asked questions about [CFR 382](#).

All school bus drivers must submit to any of the following testing:

- 1) **Pre-Employment.** Prior to the first time driving, a driver shall undergo testing for controlled substances and the employer must receive a negative test result.
- 2) **Post-Accident.** An employer shall test for controlled substances and alcohol as soon as practical following a crash.
- 3) **Random Testing.** Every driver shall submit to random controlled substance and alcohol testing.
- 4) **Reasonable Suspicion.** Your employer shall require a driver to submit to an alcohol test when the employer has reasonable suspicion to believe the driver is under the influence.
- 5) **Return to duty.** The requirements for return-to-duty testing must be performed in accordance with [49 CFR part 40, subpart O](#).

- 6) **Follow up testing.** The requirements for follow-up testing must be performed in accordance with [49 CFR part 40, subpart O](#).

Drug and Alcohol Clearinghouse

Effective January, 6, 2020, the [Federal Motor Carrier Safety Regulation, Drug & Alcohol Clearinghouse](#) will require the following:

- 1) FMCSA regulation requires employers to report to the Clearinghouse information related to violations of the drug and alcohol regulations under [Federal Motor Carrier Safety Regulation 382.701, Drug and Alcohol Clearinghouse](#).
- 2) Employers will be required to query the Clearinghouse for current and prospective employees' drug and alcohol violations before permitting those employees to operating a DMV on public roads.
- 3) Employers will be required to annually query the Clearinghouse for each driver they currently employ.

You are not physically qualified to drive a CMV if you use marijuana, even if prescribed.

[Federal Motor Carrier Safety Administration, Medical Marijuana FAQ's](#)

Unit 1.5.10 Medical Requirements

This unit must teach driver-trainees the Federal rules on medical certification, medical examination procedures, general qualifications, responsibilities, and disqualifications based on various offenses, orders, and loss of driving privileges ([49 CFR part 391, subparts B and E](#)).

Medical Examinations

All Nevada school bus drivers must be physically examined by a Federally Certified Registered Medical Examiner ([Federal Motor Carrier Safety Regulation 49 CFR 391.43\(a\)](#), [National Registry of Certified Medical Examiners](#)).

- 1) Select that you are an **INTERSTATE, NON-EXCEPTED** driver. Interstate, non-excepted drivers are required to submit a DOT medical certificate. Please be aware that if you self-certify incorrectly, you will be required to return to DMV and change your status, including paying any fees required by DMV.
- 2) Provide your current medical certificate to DMV ([Federal Motor Carrier Safety Regulation 391.41, Physical Qualifications for Drivers](#)). The Department of Motor Vehicles will suspend the driver's license of any person who fails to submit a required medical examination within 15 days after it is requested ([Nevada Administrative Code 483.320](#)).
- 3) CMV drivers with medical waivers will not be issued school bus endorsement in Nevada.
- 4) Your employer can request you be reexamined if there are concerns about your ability to operate a CMV.

**It is your responsibility to make sure that DMV
has your Medical Examiner Certificate prior to the
expiration date.**

[Nevada Commercial Driver License Manual](#), (pg. ii)

Physical Qualifications

You are physically qualified to drive a school bus if there is NO impairment of any of the following [Federal Motor Carrier Safety Regulation 391.41, Physical Qualifications for Drivers](#):

- 1) A hand or finger which interferes with prehension or power grasping.
- 2) An arm, foot, or leg which interferes with the ability to perform tasks associated with operating a CMV; or any significant limb defect or limitation which interferes with the ability to perform normal tasks associated with operating a CMV.
- 3) Has no established medical history or clinical diagnosis of diabetes mellitus which currently requires insulin injections for control unless the person meets the requirements in [Federal Motor Carrier Safety Regulation 391.46, Physical Qualification Standards for an Individual with Diabetes Mellitus Treated with Insulin for Control](#).
 - a) Prior to the examination required by [FMCSA Regulation 391.45](#) or the expiration of

a medical examiner's certificate, the individual must be evaluated by his or her "treating clinician." A treating clinician means a healthcare professional who manages and prescribes insulin for the treatment of diabetes mellitus.

- b) During the evaluation of an individual, the treating clinician must complete the [Federal Motor Carrier Safety Regulation, Insulin-Treated Diabetes Mellitus Assessment Form MCSA-5870.](#)
- c) At least annually, but no later than 45 days after the treating clinician signs and dates the Insulin-Treated Diabetes Mellitus Assessment Form (MCSA-5870) certifying that the driver has been medically examined and is free of complications from diabetes mellitus that might impair his or her ability to operate a CMV safely.
 - i) The individual is not physically qualified to operate a commercial motor vehicle if he or she is not maintaining a stable insulin regimen and not properly controlling his or her diabetes mellitus.
 - ii) An individual is not physically qualified on a permanent basis if he or she has either severe non-proliferation diabetic retinopathy or proliferative diabetic retinopathy.
 - iii) An individual is not physically qualified to operate a CMV up to the maximum 12-month period until he or she provides the treating clinician with at least 3 months of electronic blood glucose self-monitoring records while being treated with insulin.
 - iv) An individual who does not provide the treating clinician with at least the preceding 3 months of electronic blood glucose self-monitoring records while being treated with insulin is not physically qualified to operate CMV for more than 3 months.
- d) *Blood glucose self-monitoring records.* Individuals with diabetes mellitus treated with insulin for control must self-monitor blood glucose in accordance with the specific treatment plan prescribed by the treating clinician. Such individuals must maintain blood glucose records measured with an electronic glucometer that stores all readings, that records the date and time of readings, and from which data can be electronically downloaded. A printout of the electronic blood glucose records or the glucometer must be provided to the treating clinician at the time of any of the evaluations required by this section.
- e) An individual with diabetes mellitus treated with insulin for control experiences a severe hypoglycemic episode is prohibited from operating a CMV. You must report such occurrence to your treating clinician, and you must be evaluated again as soon as possible. A severe hypoglycemic episode is one that requires the assistance of others, or results in loss of consciousness, seizure, or coma. The prohibition on operating a commercial motor vehicle continues until a treating clinician:
 - i) Has determined that the cause of the severe hypoglycemic episode has been addressed,
 - ii) Has determined that the individual is maintaining a stable insulin regimen and

proper control of his or her diabetes mellitus; and

- iii) completes a new Insulin-Treated Diabetes Mellitus Assessment Form, MCSA-5870.
- 4) Has no current clinical diagnosis of myocardial infraction, angina pectoris, coronary insufficiency, thrombosis, or any other cardiovascular disease of a variety known to be accompanied by syncope, dyspnea, collapse, or congestive cardiac failure.

OSA is a respiratory dysfunction and medical examiners can require an OSA test if a driver exhibits symptoms or multiple risk factors. [Federal Motor Carrier Safety Regulation, Bulletin to Medical Examiners on OSA](#)

- 5) Has no established medical history or clinical diagnosis of a respiratory dysfunction that is not currently being managed with a medical professional likely to interfere with the ability to control and drive a CMV. This includes emphysema, chronic asthma, carcinoma, tuberculosis, chronic bronchitis, and obstructive sleep apnea (OSA) if the medical examiner detects a respiratory dysfunction, that in any way is likely to interfere with the driver's ability to safely control and drive a commercial motor vehicle.
- 6) Has no current clinical diagnosis of high blood pressure likely to interfere with ability to operate a commercial motor vehicle safely.
- 7) Has no established medical history or clinical diagnosis of rheumatic, arthritic, orthopedic, muscular, neuromuscular, or vascular disease.
- 8) Has no established medical history or clinical diagnosis of epilepsy or any other condition that could cause the loss of consciousness.
- 9) Has no mental, nervous, organic, or functional disease, or psychiatric disorder likely to interfere with the ability to drive a CMV safely.
- 10) Has distance vision acuity of at least 20/40 in each eye without corrective lenses or visual acuity separately corrected to 20/40 or better with corrective lenses, distant binocular acuity of at least 20/40 in both eyes with or without corrective lenses, field of vision of at least 70 degrees in the horizontal Meridian in each eye, and the ability to recognize the colors or traffic signals and devices showing standard, red, green, and amber.
- 11) First perceives a forced whispered voice in the better ear at not less than 5 feet or without the use of a hearing aid or, if tested by use of an audiometric device. Does not have an average hearing loss in the better ear greater than 40 decibels at 500 Hz, 1,000 Hz and 2,000 Hz with or without a hearing aid when the audiometric device is calibrated to American National Standard.
- 12) If an individual meets the criteria by using a hearing aid, the driver must wear that hearing aid and have it in operation at all times while driving. Also, the driver must be in

- possession of a spare power source for the hearing aid.
- 13) Does not use any drug or substance identified in 21 CFR 1308.11 Schedule I, an amphetamine, a narcotic, or other habit-forming drug.
 - 14) Does not use any non-Schedule I drug or substance that is identified in the other schedules in 21 CFR part 1308 except when the use is prescribed by a license medical practitioner, as defined in 382.107, who is familiar with the driver's medical history and has advised the driver that the substance will not adversely affect the driver's ability to safely operate a commercial motor vehicle.
 - 15) Has no current clinical diagnosis of alcoholism.

Medical variances and waivers are not allowed in Nevada for CDL drivers with a School Bus Endorsement.

Physical Performance Tests

The National Transportation Safety Board issued Recommendation H-19-006 which requested states require drivers pass a physical performance test annually and anytime a driver's physical condition changes in a manner that could affect the driver's ability to physically perform school bus driver duties. Drivers, at a minimum, will be expected to be able to pass the following physical performance tests:

- 1) Climb and descend bus steps 3 times in 30 seconds.
- 2) Demonstrate the ability to activate alternately the throttle and brake controls 10 times in 10 seconds.
- 3) Depress and hold the brake and pedal a minimum of 3 seconds, 5 consecutive times.
- 4) Manually open and close the bus entrance door 3 consecutive times.
- 5) Demonstrated while the vehicle is in motion, with the driver operating a minimum of 2 hand controls on both sides of the steering wheel, while maintaining control of the vehicle at all times. Each response must be completed within 8 seconds.
- 6) Starting in a seated position, leave the driver's seat and exit the bus from the rearmost floor level emergency door exit within 20 seconds.
- 7) Demonstrate the ability to drag or carry 100-pound object 30 feet in 30 seconds.
- 8) Any other performance skills test your school deems necessary to assure the driver can perform their duties.

Section 2.1 Class B Behind the Wheel Training

There are no required minimum instruction hours for BTW range training, but the instructor must cover all topics set forth in the BTW range curriculum. The instructor must document the total number of clock hours (one clock hour for each 60 minutes of instruction) each trainee takes to complete the BTW range curriculum. The instructor must document that each trainee is proficient in all elements of the BTW range curriculum for the trainee to successfully complete this module. This unit must teach driving exercises related to basic vehicle control skills and mastery of basic maneuvers, as covered in 49 CFR §§ 383.111 and 383.113. The training providers must teach this unit on a driving range as defined in § 380.605. The training provider must teach “Get Out and Look” (GOAL) to the trainee as it applies to units B2.2-2.6.

Unit 2.1.1 Behind the Wheel - Range

This unit must teach driving exercises related to basic vehicle control skills and mastery of basic maneuvers, as covered in [§§ 383.111](#) and [383.113 of this chapter](#) necessary to operate the vehicle safely. The training providers must teach driver-trainees activities in this unit on a driving range as defined in [§ 380.605](#). The training provider must teach “Get Out and Look” (GOAL) to the driver-trainee as it applies to units B2.2-2.6.

Unit 2.1 Vehicle Inspection – Pre-trip/Enroute/Post-trip

Driver-trainees must demonstrate proficiency in conducting pre-trip and post-trip inspections as specified in [§§ 392.7](#) and [396.11](#), including appropriate inspection locations. Instruction must also be provided on enroute vehicle inspections.

Unit 2.2 Straight Line Backing

Driver-trainees must demonstrate proficiency in proper techniques for performing various straight line backing maneuvers to appropriate criteria/acceptable tolerances.

Unit 2.3 Alley Dock Backing (45/90 Degree)

Driver-trainees must demonstrate proficiency in proper techniques for performing 45/90-degree alley dock maneuvers to appropriate criteria/acceptable tolerances.

Unit 2.4 Off-Set Backing

Driver-trainees must demonstrate proficiency in proper techniques for performing off-set backing maneuvers to appropriate criteria/acceptable tolerances.

Unit 2.5 Parallel Parking Blind Side

Driver-trainees must demonstrate proficiency in proper techniques for performing parallel parking blind side positions/maneuvers to appropriate criteria/acceptable tolerances.

Unit 2.6 Parallel Parking Sight Side

Driver-trainees must demonstrate proficiency in proper techniques for performing sight side parallel parking maneuvers to appropriate criteria/acceptable tolerances.

Section 3.1.1 Behind the Wheel – Public Road

There are no required minimum instruction hours required for BTW public road training, but the instructor must cover all topics set forth in the BTW public road curriculum and must document the total number of clock hours (one clock hour for each 60 minutes of instruction) each trainee takes to complete the BTW public road curriculum. The instructor must determine and document that each trainee is proficient in all elements of the BTW public road curriculum for the trainee to successfully complete this module. The instructor must engage in active two-way communication with the trainees during all active BTW public road training sessions. Skills described in units B3.8 through 3.12 of this section must be discussed during public road training, but not necessarily performed. Trainees are not required to demonstrate proficiency in the skills described in units B3.8 through 3.12.

Unit 3.1 Vehicle Controls Including: Left Turns, Right Turns, Lane Changes, Curves at Highway Speeds, and Entry and Exit on the Interstate or Controlled Access Highway

Driver-trainees must demonstrate proficiency in proper techniques for initiating vehicle movement, executing left and right turns, changing lanes, navigating curves at speed, exiting and entering the interstate, and stopping the vehicle in a controlled manner.

Unit 3.2 Shifting/Transmission

Driver-trainees must demonstrate proficiency in proper techniques for performing safe and fuel-efficient shifting.

Unit 3.3 Communications/Signaling

Driver-trainees must demonstrate proficiency in proper techniques for signaling intentions and effectively communicating with other drivers.

Unit 3.4 Visual Search

Driver-trainees must demonstrate proficiency in proper techniques for visually searching the road for potential hazards and critical objects.

Unit 3.5 Speed and Space Management

Driver-trainees must demonstrate proficiency in proper habits and techniques for adjusting and maintaining vehicle speed, taking into consideration various factors such as traffic and road conditions. Driver-trainees must demonstrate proficiency in maintaining proper speed to keep appropriate spacing between the driver-trainee's CMV and other vehicles. Instruction must include

methods for calibrating safe following distances under an array of conditions including traffic, weather, and CMV weight and length.

Unit 3.6 Safe Driver Behavior

Driver-trainees must demonstrate proficiency in safe driver behavior during their operation of the CMV.

Unit 3.7 Hours of Service (HOS) Requirements

Driver-trainees must demonstrate proficiency in the basic activities required by the HOS regulations, such as completing a Driver's Daily Log (electronic and paper), timesheet, and logbook recap, as appropriate.

Unit 3.8 Hazard Perception

Driver-trainees must demonstrate their ability to recognize potential hazards in the driving environment in time to reduce the severity of the hazard and neutralize possible emergency situations. Driver-trainees must demonstrate the ability to identify road conditions and other road users that are a potential threat to vehicle safety and suggest appropriate adjustments.

Unit 3.9 Railroad (RR)-Highway Grade Crossing

Driver-trainees must demonstrate the ability to recognize potential dangers and to demonstrate appropriate safety procedures when RR-highway grade crossings are reasonably available.

Unit 3.10 Night Operation

Driver-trainees must be familiar with how to operate a CMV safely at night. Training providers must teach driver-trainees that night driving presents specific circumstances that require heightened attention on the part of the driver. Driver-trainees must be taught special requirements for night vision, communications, speed, space management, and proper use of lights.

Unit 3.11 Extreme Driving Conditions

Driver-trainees must be familiar with the special risks created by, and the heightened precautions required by, driving CMVs under extreme driving conditions, such as heavy rain, high wind, high heat, fog, snow, ice, steep grades, and curves. Training providers must teach driver-trainees the basic driving habits needed to deal with the specific challenges presented by these extreme driving conditions.

Unit 3.12 Skid Control/Recovery, Jackknifing, and Other Emergencies

Driver-trainees must know the causes of skidding and jackknifing and techniques for avoiding and recovering from them. Driver-trainees must know how to maintain directional control and bring the CMV to a stop in the shortest possible distance while operating over a slippery surface. Driver-trainees must be familiar with proper techniques for responding to CMV emergencies, such as evasive steering, emergency braking, and off-road recovery. They must also know how to prevent or respond to brake failures, tire blowouts, hydroplaning, and rollovers.

Passenger (P) Endorsement Theory

Passenger (P) endorsement applicants must complete the curriculum outlined in this section, which applies to driver-trainees who expect to operate CMVs in the any of the vehicle groups defined in [§ 383.91\(a\)\(1\)-\(3\)](#) for which a P endorsement is required.

There is no required minimum number of instruction hours for theory training, but the training provider must cover all the topics set forth in the curriculum. There is no required minimum number of instruction hours for BTW training, but training providers must determine whether driver-trainees have demonstrated proficiency in all elements of the BTW curriculum. Training instructors must document the total number of clock hours each driver-trainee spends to complete the BTW curriculum. The training must be conducted in a passenger vehicle of the same vehicle group as the applicant intends to drive. The passenger endorsement training must, at a minimum, contain the following:

Unit C1.1 Post-Crash Procedures

This unit must teach driver-trainees appropriate post-crash procedures, including the requirement that the driver, if possible, assess his or her physical condition immediately after the crash and notify authorities, or assign the task to a passenger or other individuals at the crash scene. Also, training providers must teach driver-trainees how to obtain emergency medical assistance; move on-road vehicles off the road in minor crashes so as to avoid subsequent crashes or injuries; engage flashers, reflective triangles, and other warning devices for stopped vehicles; and properly use a fire extinguisher if necessary.

Post-Crash Procedures

This unit was discussed above in [unit 1.5.5 Post-Crash Procedures](#) for a class B CDL. Same procedures apply.

Unit C1.2 Other Emergency Procedures

This unit must instruct driver-trainees in managing security breaches, on-board fires, emergency exit and passenger evacuation training, medical emergencies, and emergency stopping procedures including the deployment of various emergency hazard signals. Instruction must also include procedures for dealing with mechanical breakdowns and vehicle defects while en route.

Emergency Evacuation Procedures

Practicing emergency evacuations is not only required, but extremely important if an actual evacuation is required ([Nevada Commercial Driver License Manual](#), pg. 10- 6).

Emergency evacuation procedures must be explained to all students. This includes knowing how to operate various emergency exits and the importance of listening to and following all instructions.

You should only **evacuate** the school bus if the following conditions exist:

- 1) If there is a fire or danger of a fire.
- 2) If there is a smell of raw or leaking fuel.
- 3) If there is a chance the school bus could be hit by another vehicle.
- 4) If the bus is in the path of a sighted tornado or rising waters.
- 5) If there are downed power lines.

If you must evacuate the school bus in an emergency, the following **must be considered**:

- 1) Are there responsible, older students who can provide assistance at emergency exits? Teach them how to assist the other students off the bus. This can be done when practicing emergency evacuation drills prior to the trip.
- 2) Determine the best type of evacuation. Can students be evacuated through all emergency exits, or just through the front, rear, side, or roof evacuation exits?

Determine a **safe place**.

- 1) At least 100 feet off the road in the direction of oncoming traffic. This will keep the students from being hit by debris if another vehicle collides with the bus.
- 2) Upwind if the bus is on fire.
- 3) As far away from railroad tracks as possible and in the direction of any oncoming train.
- 4) Upwind of the bus at least 300 feet if there is a risk from spilled hazardous materials.
- 5) In the direct path of a sighted tornado. Escort students to a nearby ditch or culvert if shelter in a building is not readily available. Direct them to lie face down, hands covering their head.
- 6) Not subject to flash floods.

General procedures for evacuating the bus.

- 1) Notify dispatch of emergency location, conditions, type of assistance needed and plan to evacuate the school bus;
- 2) Activate hazard warning lights;
- 3) Place the transmission in park, or if there is no shift point, in neutral;
- 4) Set the parking brake;
- 5) Shut off the engine;
- 6) Remove ignition key;
- 7) Notify dispatch of evacuation location, update conditions, and type of assistance needed; and
- 8) Take electronic communication devices.

Order the evacuation by giving the command **PREPARE TO EVACUATE** and provide instruction as to what emergency exits are going to be used by:

- 1) Having a student or adult assistant take their assigned posts at emergency exits;
- 2) If evacuating out the front exit door, turn toward the front of the bus and begin moving backwards to the first occupied seats. Have assistants do the same when evacuating students out the rear or side emergency exits;
- 3) Starting with either the left or the right seat, touch the shoulder of the person nearest to the aisle to indicate that the student in that seat needs to get up and head for the exit; and
- 4) Keep the students in the opposite seat by holding your hand on their shoulder until you are reaching for them to evacuate.

Move down the aisle repeating this procedure **until the bus is empty**.

- 1) Lead students to the nearest safe place.
- 2) Never move a student you believe may have suffered a neck or spinal injury unless his or her life is in immediate danger. Special procedures must be used to move neck spinal injury victims to prevent further injury.
- 3) Once students are evacuated:
 - a) Walk through the bus to ensure no students remain on the bus;
 - b) Retrieve emergency equipment;
 - c) Join waiting students. Account for all students and check for their safety;
 - d) Protect the scene. Set out emergency warning devices as necessary and appropriate; and
 - e) Prepare information for emergency responders ([Nevada Commercial Driver License Manual](#), pg. 10-7).

Breakdowns

If you experience a breakdown, you should:

- 1) Slow down, activate your turn signal, and move to the far-right lane if possible. You can also pull off onto a shoulder in order to prevent a crash;
- 2) Notify dispatch of breakdown and follow their instructions;
- 3) Set the parking brake, turn off the ignition, set hazard lights, and remove the keys;
- 4) Take your keys and place emergency warning devices as described above; and
- 5) Evacuate the bus only if necessary.

**Never leave students
unattended to seek assistance!**

Duty To Render Aid

[Nevada Revised Statute 484E.030](#)

Nevada requires the driver of any vehicle involved in a crash resulting in injury, death, or damage to any vehicle or property, shall:

- 1) Give their name, address, and the registration number of the vehicle they are driving, and upon request, provide their license to any person injured in such crash.
- 2) Give such information and upon request, surrender such license, to any police officer at the scene of the crash or who is investigating the crash.
- 3) Render to any person injured reasonable assistance, including the carrying, or the making of arrangements for the carrying, of such person to a physician, surgeon, or hospital for medical or surgical treatment if it is apparent that such treatment is necessary, or if such carrying is requested by the injured person.

Procedures For Rendering Aid

If you stop due to a crash to render aid, you need to:

- 1) Stop in a safe place;
- 2) Set the parking brake, turn off the ignition and turn on your hazard lights;
- 3) Notify dispatch of crash and 911 if necessary. Follow dispatch instructions;
- 4) If you are getting off the bus to render aid, notify dispatch;
- 5) Take your keys and communication devices;
- 6) Place emergency warning devices as described above; and
- 7) Provide first aid if necessary.

Nevada's Good Samaritan Law

Nevada law states that any person, who renders emergency aid, gratuitously and in good faith, is not liable for any civil damages as a result of any act or omission, not amounting to gross negligence, by him/her in rendering the emergency care or assistance, or as a result of any act or failure to act, not amounting to gross negligence, to provide or arrange for further medical treatment for the injured person ([Nevada Revised Statute 41.500](#)).

Medical Emergencies

A medical emergency can occur at any time on the school bus. All school bus drivers are required to have training in first aid and CPR. This training will be critical in an emergency. Make sure to follow your training and call 911 in a serious emergency that requires immediate medical attention.

Types of medical emergencies you may experience on the school bus:

- 1) Allergic reactions;
- 2) Anaphylactic shock;
- 3) Asthma;
- 4) Bites and stings;
- 5) Bleeding;
- 6) Chocking;
- 7) Dehydration;
- 8) Heat stroke;
- 9) Hyperventilation;
- 10) Nose bleeds; and
- 11) Seizures.

Unit C1.3 Vehicle Orientation

This unit must teach driver-trainees the basic physical and operational characteristics of passenger-carrying CMV (e.g., bus and motor coach), including overall height, length, width, ground clearances, rear overhang, Gross Vehicle Weight and Gross Vehicle Weight Rating, axle weights, wheels and rims, tires, tire ratings, mirrors, steer wheels, lighting, windshield, windshield wipers, engine compartments, basic electrical system, brake systems, as applicable, and spare tire storage. Additionally, training providers must instruct driver-trainees in techniques for proper driver seat and mirror adjustments.

Basic Characteristics of passenger-carrying CMV

In addition to the orientation and specifics noted above in [Unit 1.1.1](#) Passenger (P) and (S) requires additional knowledge. Motor carriers are subject to regulatory oversight when their vehicles are used on a highway in interstate commerce to transport passengers.

Under FMCSA regulations a passenger CMV is a vehicle “designed to transport” more than 15 passengers, including the driver. Designed to transport only refers to the number of designated seats. It does not include areas for standing passengers. There are multiple categories for a passenger carrying CMV.

- A bus is a motor vehicle designed, constructed and/or used to transport passengers.
- A motorcoach is a bus designed with an elevated passenger deck located over a baggage compartment.
- A minibus is designed to transport 16 or more passengers (including the driver) and is typically built on a small truck chassis.

Unit C1.4 Pre-Trip, En route, and Post-Trip Inspection

This unit must teach the driver-trainee the importance of pre-trip, en route, and post-trip inspections; and provide instruction in techniques for conducting such inspections as stated in [§392.7](#) and [396.11](#), and demonstrate their ability to inspect the following:

- 1) Emergency exits;
- 2) Passenger-carrying CMV interiors (including passenger seats as applicable);
- 3) Restrooms and associated environmental requirements;
- 4) Temperature controls (for maintaining passenger comfort);
- 5) Driver and passenger seat belts.

Additionally, training providers must instruct driver-trainees in procedures, as applicable, in security-related inspections, including inspections for unusual wires or other abnormal visible materials, interior and exterior luggage compartments, packages or luggage left behind, and signs of cargo or vehicle tampering. Finally, training providers must instruct driver-trainees in cycling-accessible lifts and procedures for inspecting them for functionality and defects.

Vehicle Inspection

In addition to the curriculum above for class B CDL drivers need to know information specific to passenger (P) and school bus (S) endorsements. Outlined in the [Nevada CDL manual pg. 4-1](#). Before driving your bus, you must be sure it is safe. You must review the inspection report made by the previous driver. Only if defects reported earlier have been certified as repaired or not needed to be repaired, should you sign the previous driver's report. This is your certification that the defects reported earlier have been fixed.

Vehicle Systems

Make sure these things are in good working order before driving: Service brakes, including air hose couplings (if your bus has a trailer or semitrailer), Parking brake, Steering mechanism, Lights and reflectors, Tires (front wheels must not have recapped or re-grooved tires), Horn, Windshield wiper or wipers, Rear-vision mirror or mirrors, Coupling devices (if present), Wheels and rims, Emergency equipment, Make sure your bus has the fire extinguisher and emergency reflectors (3 reflective triangles or at least 6 fuses or 3 liquid burning flares) required by law. The bus must also have spare electrical fuses, unless equipped with circuit breakers.

Access Doors and Panels

As you check the outside of the bus, close any open emergency exits. Also, close any open access panels (for baggage, restroom service, engine, etc.) before driving.

Bus Interior

People sometimes damage unattended buses. Always check the interior of the bus before driving to ensure rider safety. Aisles and stairwells should always be clear. The following parts of your bus must be in safe working condition: Each handhold and railing. Floor covering. Signaling devices, including the restroom emergency buzzer, if the bus has a restroom. Emergency exit handles. The seats must be safe for riders. All seats must be securely fastened to the bus. Never

drive with an open emergency exit door or window. The "Emergency Exit" sign on an emergency door must be clearly visible. If there is a red emergency door light, it must work. Turn it on at night or any other time you use your outside lights.

Temperature control

Make the passengers comfortable as possible.

Roof Hatches

You may lock some emergency roof hatches in a partly open position for fresh air. Do not leave them open as a regular practice. Keep in mind the bus's higher clearance while driving with them open.

Use Your Seatbelt!

The driver's seat should have a seat belt. Always use it for safety.

Standee Line

No rider may stand forward of the rear of the driver's seat. Buses designed to allow standing must have a two-inch line on the floor or some other means of showing riders where they cannot stand. This is called the standee line. All standing riders must stay behind it.

At Your Destination

When arriving at the destination or intermediate stops announce: The location. Reason for stopping. Next departure time. Bus number. Remind riders to take carry-ons with them if they get off the bus. If the aisle is on a lower level than the seats, remind riders of the step-down. It is best to tell them before coming to a complete stop. Charter bus drivers should not allow riders on the bus until departure time. This will help prevent theft or vandalism of the bus.

Passenger Supervision

Many charter and intercity carriers have passenger comfort and safety rules. Mention rules about smoking, drinking, or use of radio and tape players at the start of the trip. Explaining the rules at the start will help to avoid trouble later on.

After-trip Vehicle Inspection

Inspect your bus at the end of each shift. If you work for an interstate carrier, you must complete a written inspection report for each bus driven. The report must specify each bus and list any defect that would affect safety or result in a breakdown. If there are no defects, the report should say so. Riders sometimes damage safety-related parts such as handholds, seats, emergency exits, and windows. If you report this damage at the end of a shift, mechanics can make repairs before the bus goes out again. Mass transit drivers should also make sure passenger signaling devices and brake- door interlocks work properly.

Student Seat Belt Usage

- 1) Nevada law currently does not have a mandatory seat belt usage regulation for school buses. Each school/school district has the authority to develop policies and procedures for usage and penalties for non-usage. School bus drivers must know their school/school

district policy on enforcement and usage.

- 2) School bus drivers should promote usage even without a mandatory usage policy by the school/school district.
- 3) Under [Nevada Revised Statute 484D.495](#), drivers may not be considered as negligent or as a causation in any civil action or negligent for a violation of the requirement for use of lap/shoulder belts.

Proper Use of 3-Point Lap Shoulder Belts



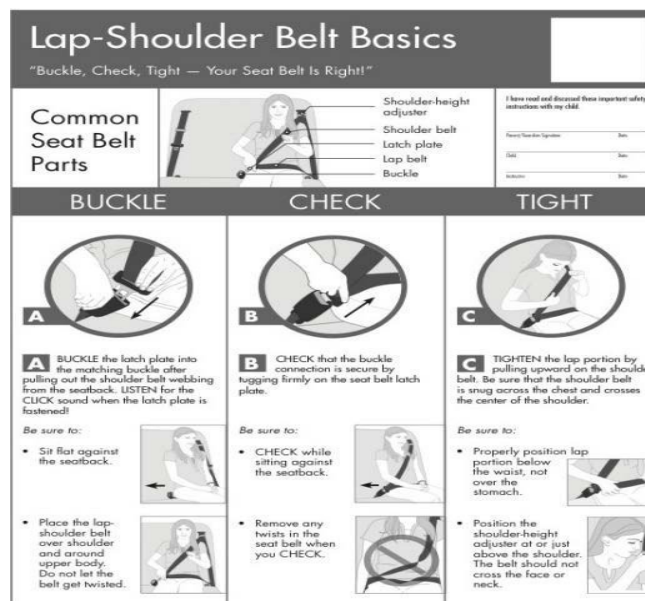







- 1) Train students to sit flat against the backseat.
- 2) Train students to place the lap shoulder belt over the shoulder and around the upper body. Do not let the belt get twisted.
- 3) Train students to buckle the latch plate into the matching buckle after pulling out the shoulder belt webbing from the seatback. Listen for the CLICK sound when the latch plate is fastened.
- 4) Train students to make sure that the lap belt is properly positioned below the waist, not over the stomach.
- 5) Train students to position the shoulder-height adjuster at or just above the shoulder. The belt should not cross the face or neck.



Improper Use of 3-Point Lap Shoulder Belts

- 1) Instruct students to never sit in front of the buckled lap shoulder belt.
- 2) Instruct students to never place the shoulder belt behind their back and wear only the lap belt.
- 3) Instruct students to never place the shoulder belt under their arm.

- 4) Instruct students to never allow the belt webbing to be twisted. It should lay flat against your body.
- 5) Instruct students to never insert the latch plate of your shoulder belt into the buckle for the seat beside you. Be sure students use their own buckle.
- 6) Instruct students to never wear their backpack when seated in the bus. Place it on the floor in front of your feet.
- 7) Never sit on the front or side edge of your seat.

UNBUCKLING	
	
<ol style="list-style-type: none"> 1. Push the red button on the buckle and remove the latch plate from the buckle. 2. Allow the shoulder belt to retract into the upper seatback so webbing is not loose. 	<ol style="list-style-type: none"> 3. As a courtesy to the next passenger, move the shoulder-height adjuster up to its highest position.
IMPROPER LAP-SHOULDER BELT USE	
	<p>NEVER sit in front of the buckled lap-shoulder belt.</p>
	<p>NEVER place the shoulder belt behind your back and wear only the lap belt.</p>
	<p>NEVER place the shoulder belt under your arm.</p>
	<p>NEVER wear the shoulder belt or lap belt loosely.</p>
	<p>NEVER allow the belt webbing to be twisted. It should lay flat against your body.</p>
	<p>NEVER insert the latch plate of your shoulder belt into the buckle for the seat beside you. Be sure to use your own buckle.</p>
	<p>NEVER wear your backpack when you are seated in the bus. Place it on the floor in front of your feet.</p>
	<p>NEVER sit on the front or side edge of your seat.</p>

© 2014 NSTSAP Rev 01 07/14

[National School Transportation Specifications and Procedures, 2015](#) (pg. 397)

Unit C1.5 Fueling

This unit must instruct driver-trainees on the significance of avoiding refueling a bus while passengers are onboard and the imperative of avoiding refueling in an enclosed space.

Refueling

Avoid fueling your bus with riders on board unless absolutely necessary. Never refuel in a closed building with riders on board. Never refuel in a closed space with passengers where fumes can build up in the compartment with no escape. Fumes can be odorless, tasteless, and colorless making them hard to detect making them very dangerous.

Unit C1.6 Idling

This unit must teach driver-trainees the importance of compliance with State and local laws and regulations, including for example, idling limits, fuel savings; and the consequences of non-compliance, including adverse health effects and penalties.

Idling

In addition to the information provided in the curriculum above for a class B CDL Drivers seeking a passenger endorsement need to know the basics of idling.

State law says that you shall not idle a bus for more than 15 consecutive minutes. If parking at a school or any other parking lot, you must turn off your engine after 15 minutes ([Nevada Administrative Code 445b.575](#)). In addition to increased fuel consumption idling releases carbon monoxide and hydrocarbons which can have health effects and lead to penalties if over the 15-minute rule.

You are not allowed to idle your school bus engine for more than 15 minutes.

[Nevada Administrative Code 445B.575](#)

Unit C1.7 Baggage and/or Cargo Management

In this unit, training providers must teach driver-trainees:

- 1) Proper methods for handling and securing passenger baggage and containers, as applicable.
- 2) Procedures for identifying and inspecting baggage and containers for prohibited items, such as hazardous materials.
- 3) Proper handling and securement of devices associated with the Americans with Disabilities Act (ADA) compliance, including oxygen, wheeled mobility devices, and other associated apparatuses.

Handling and Securing Passenger Cargo Loading and Trip Start

Do not allow riders to leave carry-on baggage in a doorway or aisle. There should be nothing in the aisle that might trip other riders. Secure baggage and freight in ways that avoid damage and: Allow the driver to move freely and easily. Allow riders to exit by any window or door in an emergency. Protect riders from injury if carry-ons fall or shift.

Hazardous Materials

Watch for cargo or baggage containing hazardous materials. Most hazardous materials cannot be carried on a bus. Containers will often be labeled with a placard on the outside of the container.

Forbidden Hazardous Materials

Commercial Passenger Buses may carry small-arms ammunition labeled ORM-D, emergency hospital supplies, and drugs. You can carry small amounts of some other hazardous materials if the shipper cannot send them any other way. Buses must never carry: Division 2.3 poison gas, liquid Class 6 poison, tear gas, irritating material. More than 100 pounds of solid Class 6 poisons. Explosives in the space occupied by people, except small arms ammunition. Labeled radioactive materials in the space occupied by people. More than 500 pounds total of allowed hazardous materials, and no more than 100 pounds of any one class.

Riders sometimes board a bus with an unlabeled hazardous material. Do not allow riders to carry on common hazards such as car batteries or gasoline ([NV CDL manual pg. 4-2](#)).

A school bus should never have any hazardous material onboard unless meeting ADA compliance.

Specialized Assistive Equipment

[National Highway Traffic Safety Administration, Transporting Students with Special Needs](#) (Section IV, Specialized Equipment)

Passengers with special needs may use a variety of specialized equipment requiring special care and use. One of the most challenging to transport is the wheelchair.

Some of the specialized equipment or assistive devices you might encounter as a bus driver/attendant of students with special needs are:

- 1) Braces or crutches;
- 2) Walker or cane;
- 3) Wheelchair;
- 4) Tracheotomy tube;
- 5) IV or feeding tube;
- 6) Lap tray;
- 7) Oxygen equipment;
- 8) Child safety seat or safety vest;
- 9) A guide dog/service animal;
- 10) Extra belt cutters;
- 11) Do Not Resuscitate (DNR) orders; and
- 12) Medical support equipment. This may include respiratory devices, such as oxygen bottles or ventilators ([National Congress on School Transportation Specifications and Procedures](#), pg. 77).

Wheelchair Tie-down Occupant Restraint System (WTORS)

WTORS shall be designed, installed, and operated for use with forward-facing wheelchair-seated passengers. It is important to use a complete WTORS to secure the wheelchair and provide the occupant with a properly designed and tested securement system. When securing a wheelchair in the school bus, you will need the following securement systems.

- 1) There are 7 securement points:
 - a) A 4-point securement system that anchors the wheelchair to the vehicle; and
 - b) A 3-point securement system that secures the student in the wheelchair that includes a shoulder belt that attaches to the vehicle and a lap belt.
- 2) To protect the occupant, a seatbelt system with both pelvic and upper torso belts must be used.
- 3) The WTORS, including anchorage track, floor plates, pockets, or other anchorages, and shall be provided by the same manufacturer.
- 4) Wheelchair securement positions shall be located such that wheelchair and their occupants do not block access to the lift door.
- 5) Immediately after their use, all securement hardware not permanently affixed to vehicle floors and sidewalls (tracks, plate) should be detached and stored in a bag, box, or other compartment.
- 6) A device for storage of the WTORS shall be provided. When the system is not in use, the storage device shall allow for clean storage of the system, shall keep the system securely contained within the passenger compartment, shall provide reasonable protection from

vandalism, and shall enable the system to be readily accessed for use.

- 7) If the upper torso belt anchorage is higher than 44 inches, measured from the vehicle floor, an adjustment device as part of the occupant restraint system must be supplied ([National School Transportation Specifications and Procedures](#), pg. 75).

Storage of Specialized Equipment

Specialized equipment must never be secured in:

- 1) Aisles;
- 2) Where it can become a projectile;
- 3) The evacuation path;
- 4) A student's lap; and
- 5) Between the seat and the window. Other lightweight items may be secured in:
 - 1) In seat belts in unoccupied seats;
 - 2) Cargo nets fixed to the side or back walls of the school bus;
 - 3) Under seats;
 - 4) Latched compartments; or
 - 5) At the rear of the bus.

Remember that all objects can become projectiles in a crash. So, all items must be stored properly. This includes brooms and any other supplies or equipment you carry on the school bus.

Child safety seats must be either secured to the seat with or without the children, or stored in a storage area, or taken off the school bus with the child.

All securement straps and hardware not secured to the floor and sidewalls must be detached and stored in a bag, box, or other compartment. (OOS)

Unit C1.8 Passenger Safety Awareness Briefing

This unit must teach driver-trainees how to brief passengers on safety topics including fastening seat belts, emergency exits, emergency phone contact information, fire extinguisher location, safely walking in the aisle when the bus is moving, and restroom emergency push button or switch.

Safety Awareness Briefing

Passengers aware of the safety features of the motorcoach they are traveling on may be more likely to utilize features, such as safety belts, while being knowledgeable of emergency features, such as emergency exits, in the event they need to access them.

Guidance from the Federal Motor Carrier Safety Administration details both the minimum content and timing of these passenger safety briefings. The passenger safety briefing should include at least the following:

- Instruction to follow driver direction and instructions in the event of any emergency or safety issue.
- Tips on avoiding passenger injuries due to slips, trips and falls while on the motorcoach. These tips should include: staying seated while the coach is in motion; keeping aisle/walkways clear of obstructions; and methods available to steady and support oneself if moving about the coach while it is in motion.
- The location and operation of all emergency exits (windows and roof hatches). The service door should be emphasized as the primary exit in any emergency.
- The location of on-board fire extinguishers in the passenger compartment.
- Who the passengers should notify in an emergency (should the driver be incapacitated).
- The presence of the emergency call button located in the restroom.

For motorcoaches equipped with safety belts, drivers should also remind passengers that seatbelts are available, and their use is encouraged.

Frequency and Timing

In addition to safety briefing topics, guidance was also provided on the timing and frequency of passenger safety briefings. When, and how often, these briefings should be provided is dependent upon the type of trip being operated.

For demand responsive trips - charters and tours – the safety briefings should be provided after passenger boarding and prior to beginning the trip. If you are with the same group on a multi- day trip, passenger safety briefings only need to be repeated if a motorcoach change occurs.

For fixed route trips, passenger safety briefings should be provided after boarding and prior to beginning the trip and repeated thereafter at all major stops and terminals.

Unit C1.9 Passenger Management

In this unit, training providers must teach driver-trainees:

- 1) Proper procedures for safe loading and unloading of passengers prior to departure, including rules concerning standing passengers and the standee line.
- 2) Procedures for dealing with disruptive passengers.

Loading and Unloading

As the driver you should always stand on the downhill side of the door when passengers are loading and unloading. Steps to get on and off the bus has the potential for injury. Passengers should board the bus one at a time, utilize all steps in the stairwell and use the handrail at all times if able. Generally, the first step that is closest to the ground will be the highest rise for passengers to step onto. If a passenger is having difficulty, they may need assistance from you or a stepstool if available. You should offer assistance before providing it.

Passenger Awareness

Some passengers will ask for assistance others may not. Pay attention while your greeting passengers for any signs that assistance may be required. If you see a person that may need help based on physical condition or appearance, simply ask them. Reminding passengers to use the handrail, to not rush or to exercise caution raises awareness and may help prevent unintentional injury. Some passengers maybe carrying too much in their hands to use the handrail in this event remind the passenger to watch their step or offer assistance.

Unloading Procedures

When parking the bus, park in a manner where the passengers are either able to step directly onto a curb or the ground. Make the choice obvious by positioning the bus close enough to or far away enough from a curb to avoid confusion as to where they will step off to. Injury can happen when passengers try to overextend themselves to reach a curb out of their reach.

Standing Passengers and Standee Line (School buses do not allow standees)

Some buses will have accommodations for standing passengers. Even when a bus accommodates it is not preferable to have a passenger stand if seats are available due to fall risk. If standing, they should utilize the added handrails. These buses also have a standee line near the driver's seat. This line is a marker on the aisle the standing passengers must not cross as to not interfere with the Driver's ability to operate the vehicle safety.

Disruptive Passengers

Recognize the emotion of the passenger, politely ask the passenger to remain seated (if applicable), ask the passenger questions while not arguing or escalating the situation, make a decision that will help defuse the situation (ex: finding a safe location to pull over). Assess the amount of risk they pose to you and other passengers. Consider contacting dispatch if necessary

Unit C1.10 Americans with Disabilities Act (ADA) Compliance

Along with addressing the proper operation of accessibility equipment (e.g., lifts), this must teach driver-trainees the applicable regulations and proper procedures for engaging persons with disabilities or special needs under the ADA. Training must cover passengers with mobility issues, engaging passengers with sight, hearing, or cognitive impairments, and recognizing the permitted use of service animals.

Special needs

When driving with the disabled this could mean taking extra measures to ensure safe transportation. As a driver you may have to help others with disabilities to safely ride the bus. This may require physical, or verbal assistance. A person with vision impairments may need to be guided, physical impairments may need assistance securing with seatbelts, or hard of hearing with an effective means of communication. Always build positive relationships and speak with dignity and respect as you would any passenger.

Transporting Specialized Assistive Equipment

Transporting Oxygen

Oxygen is a non-flammable substance that is stored in liquid or gas form and used by a student to aid in breathing. If a school bus In order to transport oxygen, the bus driver needs to know the following information that needs to be documented in the student's IEP.

- 1) The type and size of the oxygen tank that will be transported, along with an emergency plan in the event of a medical emergency or equipment failure.
- 2) Oxygen tanks should be no larger than 38 cubic feet for compressed gas.
- 3) If the student is using the oxygen on an as needed basis. The bus driver cannot make the decision regarding the amount of oxygen needed.
- 4) Oxygen tanks must be secured in a rack or mounting device that will sustain at least five times the weight of the tank.
- 5) All oxygen tanks must be kept away from intense heat (130 degrees or higher) or friction.
- 6) Unless absolutely necessary, only one medical support device per student can be transported at a time.
- 7) Any changes in medical equipment or required services may require a change in the IEP. Notify your supervisor immediately.
- 8) School buses are not required to have placards or labeling on the vehicle when transport.

Transporting Service Animals

Service animals are dogs that are individually trained to work or perform tasks for people with disabilities. ADA regulations require that state and local governments, businesses, and nonprofit organizations that serve the public must allow service animals to accompany people with disabilities in areas of the facility where the public is normally allowed.

Bus drivers are not responsible for determining if a service animal is required for a student while being transported on the school bus. If a service animal is required for a student, the IEP should review and approve the service animal on the school bus.

- 1) Services provided by service animals for students with special needs.
 - a) For students who are physically weak or experience fatigue, service dogs can actually pull them in their wheelchairs, providing longer periods of independent mobility.
 - b) For students who have visual or memory problems, the dogs can help lead them throughout the school and bus area.
 - c) For students with seizure activity, the dogs can give the student a warning that they are going to have a seizure.
 - d) For students with balance and walking difficulties, the dogs can provide physical support to aid with walking, balance, and coordination.
 - e) For students with limited upper extremity movement and strength, the service dogs can pick up objects that might be out of the students' reach or ability.
 - f) For students who use motorized wheelchairs, service dogs have often been trained to pick up the students' arms if they drop and place them back on the wheelchair joystick box.
 - g) For those with phobias or emotional disturbance disorders, the dogs provide a calming effect.
 - h) In many cases, the service animal provides a social opportunity for the child where one would not have occurred otherwise ([National School Transportation Specifications and Procedures](#), pg. 421).
- 2) Federal rules related to service animals.
 - a) Allergies and fear of dogs are not valid reasons for denying access or refusing service to people using service animals. When a person is allergic to dog dander and a person who uses a service animal must spend time in the same room, like the school bus, they both should be accommodated.
 - b) A person with a disability cannot be asked to remove their service animal unless the dog is out of control and the student does not take effective action to control the dog.
 - c) Students with disabilities who use service animals cannot be isolated from other students or treated less favorably.
 - d) Students can be charged for any damage caused by a service animal.
 - e) You are not required to provide care or food for the service animal.

- f) In addition to the provisions about service dogs, revised ADA regulations have a new provision for miniature horses that have been individually trained to perform tasks or work with students with a disability ([United States Department of Justice: ADA Requirements for Service Animals](#)).
- 3) Loading students with service animals.
- a) Never allow a service animal to ride the bus lift.
 - b) Lead the service animal up the steps while the student is on the lift and the lift is still on the ground to provide maximum safety for the dog and child.
 - c) Ambulatory students should ascend the steps separately, with the service animal boarding first so it doesn't block or trip the child during boarding.
- 4) Riding position and safety.
- a) Once the student and dog are on the bus, the best position for the service animal is between the wheelchair and the bus wall.
 - b) Decisions should be made as to whether the service animal should be restrained or remain free to assist the student according to the student's individual needs. The important thing is to minimize potential injury to the service animal and others on the bus in case of a crash.
 - c) The service animal should never be allowed to block the aisle. Depending on space available, an ambulatory student's service animal may be placed on the floor near the student's immediate seating area.
 - d) The service animal's safety during the actual bus ride with all the stops and acceleration should come into consideration.
 - e) A service animal cannot block any emergency exit.
 - f) Emergency procedures should be established along with evacuation plans.
 - g) A service animal may be taken off the bus via the steps or allowed to jump of the back of the bus without assistance.
 - h) Students or their parents should train bus staff in basic commands, should the student be unable to give the service animal commands.
 - i) Handling of an injured service animal during an emergency should be left to the direction of the handler. In the event that the handler becomes incapacitated, first responders should determine the best method of evacuation.
 - j) Dog behavior management. If a service animal begins to bark, groan or whine, question what is causing the service animal to act this way and consult with the student/handler to interpret the behavior when possible. Make sure that something is not wrong with the student or animal ([National School Transportation Specifications and Procedures](#), pg. 421).



Wheelchairs

There are many kinds of wheelchairs. They range widely in cost from hundreds of dollars to tens of thousands of dollars and have a variety of features. Some examples include:

- 1) Lap trays;
- 2) Forearm positioning device;
- 3) Tilt and recline options;
- 4) Various harnesses;
- 5) Joysticks; and
- 6) Different head and footrests.



Wheelchair Characteristics

- 1) Some wheelchairs are manufactured for transportation purposes. When they are, they will have a label stating they are manufactured for transportation.
- 2) This doesn't mean that students can't use mobile seating devices/wheelchairs that are not manufactured for transportation purposes.
- 3) Students should be transported in wheelchairs manufactured for transportation or whenever possible be transferred to a regular seat in the school bus.
- 4) Some students cannot get on the bus without a wheelchair but can sit in a regular seat. It is recommended that whenever possible, students be transferred to a regular seat on the school bus.
- 5) The wheelchair must be secured even if not used by the student.
- 6) Some wheelchairs are not always safe to transport students in. When a wheelchair is structurally unsafe to transport, you will need to contact your supervisor to come up with an alternate transportation plan ([National Highway Traffic Safety Administration, Transporting Students with Special Needs-Specialized Equipment](#)).
- 7) Some mobile seating devices the student cannot remain seated in during transportation:
 - a) A wheelchair with a sports back; and
 - b) A 3-wheeled scooter.



- 8) Be aware of:
 - a) An extra heavy wheelchair that requires additional tie-downs; and
 - b) The "tilt-in-space" wheelchair if tilted more than 20 degrees.

Power Wheelchairs

Power wheelchairs are loaded like manual wheelchairs except for the following:

- 1) The power is switched off and battery is charged before operating the lift;
- 2) The wheel locks are engaged;
- 3) For some chairs, the gears on the motors must be disengaged;
- 4) The gears on the motors should be re-engaged to set the internal locking mechanism while the wheelchair is on the lift; and
- 5) The gears need to be engaged to allow the student or aide to maneuver the power

wheelchair into the securement position if they are capable.



Tilt ‘n Space Wheelchair

These wheelchairs require additional securement straps. If this wheelchair is tilted more than 20 degrees, the shoulder belt won’t work correctly. Students in these types of wheelchairs should be loaded in them and if possible, transfer the student to a regular seat in the school bus.



WC 19 Wheelchairs



- 1) WC19 wheelchairs meet voluntary standards for design, testing, and labeling. The WC19 standard is designed to work in combination with the standard for wheelchair tie-downs and occupant restraints. It provides for the use of crash-tested, four-point, strap-type tie-downs and three-point occupant restraint over the torso and pelvis.
- 2) A WC19-compliant wheelchair is strong enough to provide effective support for the wheelchair rider in a wide range of crash and emergency vehicle maneuvers.
- 3) It also makes it faster and easier to secure the chair because it has four clearly marked and easy to reach securement points where tie-down hooks and straps can be attached.

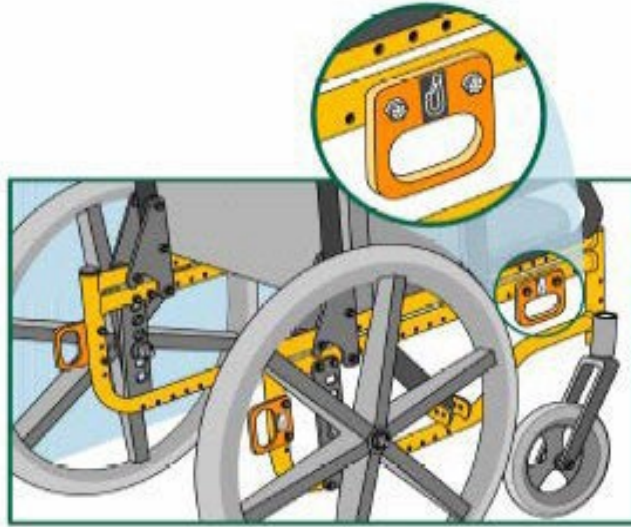

- 4) If a WC19 wheelchair is not available, the next best choice is a wheelchair with an accessible metal frame to which tie-down straps and hooks can be attached at frame junctions.

WC19 Wheelchair Symbols

If you do not have a WC19 wheelchair, it is best to attach the tie-down hooks or straps to welded junctions of the frame or to other structural areas where the frame is fastened together with hardened steel bolts – often indicated by six raised lines or bumps on the bolt head ([National School Transportation Specifications and Procedures](#), pg. 445).

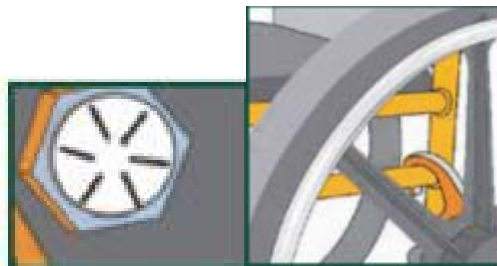

Unit C1.11 Hours of Service (HOS) Requirements

This unit must teach driver-trainees the HOS regulations that apply to drivers for interstate passenger carriers. Training providers must teach driver-trainees the basic activities required by the HOS regulations, such as completing a Driver's Daily Log (electronic and paper), timesheet, and logbook recap, as appropriate. Training providers must teach driver-trainees how to recognize the signs of fatigue and basic fatigue countermeasures as a means to avoid crashes.

Recap Hours of Service requirements

Hours of service requirements are similar to the above in the class B CDL curriculum. Recap above for timesheets, logbooks, fatigue, and basic fatigue countermeasures ([Unit 1.5.3 Hours of Service Requirements](#) and [Unit 1.5.4 Fatigue and Wellness Awareness](#)).

Passenger-carrying drivers:

- Are limited to driving 10 hours after 8 consecutive off duty hours.
- May not drive after having been on duty for 15 hours.
- May not drive 60/70 hours on duty in 7/8 consecutive days.
- Drivers are allowed to extend the 10-hour maximum driving time and 15-hour on-duty limit by up to 2 hours when adverse driving conditions are encountered.

Unit C1.12 Safety Belt Safety

This unit must teach driver-trainees the Federal rules governing the proper use of safety restraint systems by CMV drivers, as set forth in [§ 392.16](#).

49 CFR 392.16

Drivers.

Seat belts are required for the driver during operation.

No driver shall operate a commercial motor vehicle, and a motor carrier shall not require or permit a driver to operate a commercial motor vehicle, that has a seat belt assembly installed at the driver's seat unless the driver is properly restrained by the seat belt assembly.

Passengers.

Seat belts are not required for passengers on a bus. Seat belts are required passengers for non-passenger CMVs.

No driver shall operate a property-carrying commercial motor vehicle, and a motor carrier shall not require or permit a driver to operate a property-carrying commercial motor vehicle, that has seat belt assemblies installed at the seats for other occupants of the vehicle unless all other occupants are properly restrained by such seat belt assemblies.

Unit C1.13 Distracted Driving

This unit must teach driver-trainees FMCSA regulations that prohibit drivers from texting or using hand-held mobile phones while operating their vehicles (e.g., [§§ 392.80](#) and [392.82](#)); and must teach the serious consequences of violations, including crashes, heavy fines, and impacts on a motor carrier's and/or driver's safety records, such as driver disqualification.

Distracted Driving

Recap [Unit 1.2.3 Distracted Driving](#). Distracted driving rules apply regardless of vehicle being operated.

Unit C1.14 Railroad (RR) – Highway Grade Crossings and Drawbridges (This Does Not Apply to School Buses)

This unit must instruct driver-trainees in applicable regulations, techniques, and procedures for navigating RR-highway grade crossings and drawbridges appropriate to passenger buses.

Driving Procedures

Never Race a Train to a Crossing. Never attempt to race a train to a crossing. It is extremely difficult to judge the speed of an approaching train ([Nevada CDL Manual, pg. 4-3](#)).

Reduce Speed

Speed must be reduced in accordance with your ability to see approaching trains in any direction, and speed must be held to a point which will permit you to stop short of the tracks in case a stop is necessary.

Don't Expect to Hear a Train.

Trains may not or are prohibited from sounding horns when approaching some crossings. Public crossings where trains do not sound horns should be identified by signs. Noise inside your vehicle may, also prevent you from hearing the train horn until the train is dangerously close to the crossing.

Don't Rely on Signals

You should not rely solely upon the presence of warning signals, gates, or flagmen to warn of the approach of trains. Be especially alert at crossings that do not have gates or flashing red light signals.

Double Tracks Require a Double Check

Remember that a train on one track may hide a train on the other track. Look both ways before crossing. After one train has cleared a crossing, be sure no other trains are near before starting across the tracks.

Yard Areas and Grade Crossings in Cities and Towns

Yard areas and grade crossings in cities and towns are just as dangerous as rural grade crossings. Approach them with as much caution.

Railroad-highway Crossing/ Stops

Stop at RR Crossings: Stop your bus between 15 and 50 feet before railroad crossings. Listen and look in both directions for trains. You should open your forward door if it improves your ability to see or hear an approaching train. Before crossing after a train has passed, make sure there isn't another train coming in the other direction on other tracks. If your bus has a manual transmission, never change gears while crossing the tracks. You do not have to stop but must slow down and carefully check for other vehicles: At streetcar crossings. Where a policeman or flagman is directing traffic. If a traffic signal is green. At crossings marked as "exempt" or "abandoned" ([Nevada CDL Manual pg. 4-3](#)).

Drawbridges

Stop at drawbridges that do not have a signal light or traffic control attendant. Stop at least 50 feet before the draw of the bridge. Look to make sure the draw is completely closed before crossing. You do not need to stop, but must slow down and make sure it's safe, when: There is a traffic light showing green. The bridge has an attendant or traffic officer who controls traffic whenever the bridge opens ([Nevada CDL Manual, pg. 4-3](#)).

Unit C1.15 Weigh Stations

This unit must teach driver-trainees the weigh-station regulations that apply to buses.

Weigh Stations

One of the most important functions of a weight station is to determine whether the vehicle is overloaded.

It is the driver's responsibility to know the requirements for Weigh stations in the state they are traversing. Some states require any commercial vehicle to be weighed based solely on weight, while other states may require if over a weight and passenger count.

Upon approaching a weigh station there will often be a sign which may include the following: distance, direction, speed limit, open status, possible exemptions, etc.

A weigh station may be rolling that allows you to keep the vehicle in motion while it is being weighed, while others will require you to stop. They may at that time review your hours of service to ensure you are in compliance and may even inspect your equipment. Failure to stop at required stations may vary depending on state but may result in disqualification or even jail time in some jurisdictions.

Unit C1.16 Security and Crime

This unit must teach driver-trainees the basic techniques for recognizing and minimizing physical risks from criminal activities.

Security and Crime

While we all wish that security was not a potential concern, history has proven otherwise. Drivers who develop consistent processes during the critical times of boarding and alighting passengers can greatly decrease the risk of passenger injury as well as foresee any possible passenger or security issues, thereby ensuring a successful and safe trip for all. Sometimes it isn't always obvious, and you will need to pay closer attention to the passenger.

Passenger Screening

When greeting passengers in addition to good customer service you can observe and get a lot of information about them. Look for unusual behavior that can be a security and safety concern.

Throughout the course of your driving, you will come to learn what is normal responses and behavior as you greet your passengers. If a passenger doesn't let another passenger speak for themselves or is controlling of their actions, it is a red flag. If you can smell that they are intoxicated or show physical signs of being under the influence of something they have a chance to become disorderly. If they are nervous or jumpy passenger when you greet them, they could be a potential safety risk. If they are over dressed for weather conditions or are overprotective of their luggage, they could be hiding something. Sometimes it can be obvious and a person could indicate something illegal like a bomb threat, something is wrong or ask for help from another passenger. Never assume a person is joking if they indicate a potential safety, or legal issue.

Luggage Screening

Similar to observing and screening passengers, luggage observation while loading is key to identifying potentially dangerous or suspicious packages a passenger may be attempting to transport on your motorcoach. As with any security-related concern, you will learn what is "ordinary" over the course of being a driver – and recognizing out of the ordinary will become intuitive.

If you observe a passenger who appears to be overly possessive or concerned about his luggage during the passenger boarding process, close attention should be paid to the parcels for any signs of danger. If a customer insists on loading their luggage themselves, drivers may allow them to do so but should check the luggage for suspicious signs after they board the coach. This will require strategic placement and loading of luggage, so it can be readily screened.

For passengers boarding with carry-ons, take note of anything unusual with respect to their carry-ons. For instance, if they are attempting to carry on a full-size suitcase instead of stowing it in the luggage bays, concerns and questioning should ensue. For luggage being stowed in the luggage bays, be cognizant of any of the following signs or concerning characteristics:

- Parcels that are unusually heavy for their size

- Parcels that emit unusual odors
- Parcels that obviously contain large amounts of liquid or are wet
- Parcels containing unusual contents such as metal, pipes, nails, or ball bearings (opening parcels for inspections is not advised unless something concerning is obvious or can be felt through soft-sided luggage).

Response

If you do see crime or safety concerns always reach out to authorities for assistance. Never put you or the other passengers at risk by trying to handle a situation yourself. Do not unnecessarily escalate a situation. If applicable, try to be discrete until help can arrive.

Unit C1.17 Roadside Inspections

This unit must teach driver-trainees what to expect during a standard roadside inspection conducted by authorized personnel. Training providers must teach driver-trainees what passenger-carrying vehicle and driver violations are classified as out-of-service (OOS), including the ramifications and penalties for operating a CMV when subject to an OOS order as defined in [§ 390.5](#).

Inspections

Recap and review [Unit 1.4.2 Roadside Inspections](#) curriculum for a Class B CDL.

In states that receive federal MCSAP grant funds they must adhere to the Safe, Accountable, Flexible, Efficient Transportation Equity Act: A Legacy for Users (SAFETEA-LU). As part of the SAFETEA-LU Congress established a new section, [49 CFR 350.207\(a\)\(19\)](#). Stating that except in the case of an imminent or obvious safety hazard, ensure that an inspection of a vehicle transporting passengers for a motor carrier of passengers is conducted at a bus station, terminal, border crossing, maintenance facility, destination, or other location where a motor carrier may make a planned stop (excluding a weigh station). This doesn't mean inspection won't happen roadside just that it is less likely to occur roadside. You may be directed to another facility in which inspection will occur. If this happens you must comply and go to the designated area. All standard inspection rules and ramifications will apply.

Unit C1.18 Penalties and Fines

This unit must teach driver-trainees the potential consequences of violating driver-related regulations, including impacts on driver and motor carrier safety records, adverse impacts on the driver's Pre-employment Screening Program record; financial penalties for both the driver and carrier; and possible loss of CMV driving privileges.

Penalties and fines

In addition to the above disqualification penalties in the previous units there can be additional ramifications for you and your employer. Failure to follow applicable state and federal laws can result in fines and jail time. Employers that knowingly promote or disregard safety regulations can also be held liable. Driving records are kept and maintained by the Department of Transportation. Many employers do use the [FMCSA pre-employment screening program](#). A violation and loss of a job at one employer can prevent you from getting hired elsewhere. A driver may request their own record for review for a small fee.

Unit C2.1.1 Behind the Wheel – Range and Public Road

This BTW training consists of exercises related to basic vehicle control skills and mastery of basic maneuvers necessary to operate the vehicle safely. Activities in this unit will take place on a driving range or a public road as defined in [§ 380.605](#). The instructor must engage in active communication with the driver-trainees during all BTW training sessions.

Unit C2.1 Vehicle Orientation

Driver-trainees must demonstrate their familiarity with basic passenger-carrying CMV physical and operational characteristics including overall height, length, width, ground clearances, rear overhang, gross vehicle weight and gross vehicle weight rating, axle weights, wheels and rims, tires, tire ratings, mirrors, steer wheels, lighting, windshield, windshield wipers, engine compartments, basic electric system, and spare tire storage. Additionally, driver-trainees must demonstrate techniques for proper driver's seat and mirror adjustments.

Unit C2.2 Pre-Trip, Enroute, and Post-Trip Inspection

Driver-trainees must demonstrate proficiency in conducting such pre-trip, enroute and post-trip inspections of buses and key components of [§§ 392.7](#) and [396.11](#), and demonstrate their ability to inspect the following:

- 1) Emergency exits;
- 2) Passenger-carrying CMV interiors (including passenger seats as applicable);
- 3) Restrooms and associated environmental requirements;
- 4) Temperature controls (for maintaining passenger comfort); and
- 5) Driver and passenger seat belts.

Additionally, driver-trainees must demonstrate their knowledge of procedures, as applicable, in security-related inspections, including inspections for unusual wires or other abnormal visible materials, interior and exterior luggage compartments, packages or luggage left behind, and signs of cargo or vehicle tampering. Driver-trainees must be familiar with the operation of cycling-accessible lifts and the procedures for inspecting them for functionality and defects. For passenger-carrying vehicles equipped with said lifts and tie-down positions, trainee must demonstrate their ability to operate the cycling-accessible lifts.

Unit C2.3 Baggage and/or Cargo Management

In this unit, driver-trainees must demonstrate their ability to:

- 1) Properly handle passenger baggage and containers to avoid worker, passenger, and non-passenger related injuries and property damage;

- 2) Visually inspect baggage and containers for prohibited items, such as hazardous materials and identify such items;
- 3) Properly handle and secure devices associated with ADA compliance including oxygen, wheeled mobility devices, and other associated apparatuses.

Unit C2.4 Passenger Safety Awareness Briefing

Driver-trainees must demonstrate their ability to brief passengers on safety on topics including: Fastening seat belts, emergency exits, emergency phone contact information, fire extinguisher location, safely walking in the aisle when the bus is moving, and restroom emergency push button or switch.

Unit C2.5 Passenger Management

In this unit, driver-trainees must demonstrate their ability to safely load and unload passengers prior to departure and to deal with disruptive passengers.

Unit C2.6 Railroad-Highway Grade Crossings

Driver-trainees must demonstrate proper procedures for safely navigating railroad-highway grade crossings in a passenger-carrying CMV.

Unit D1.1 School Bus Endorsement Training Curriculum Theory Instruction

School bus (S) endorsement applicants must complete the curriculum outlined in this section, which applies to driver-trainees who expect to operate a “school bus” as defined in [§ 383.5](#). There is no required minimum number of instruction hours for theory training, but the training provider must cover all the topics set forth in the curriculum. There is no required minimum number of instruction hours for BTW training, but the training provider must determine whether driver-trainees have demonstrated proficiency in all elements of the BTW curriculum. Training instructors must document the total number of clock hours each driver-trainee spends to complete the BTW curriculum. The training must be conducted in a school bus of the same vehicle group as the applicant intends to drive. The school bus endorsement training must, at a minimum, include the following:

Much of what you will need for the school bus and passenger endorsements have been worked into the previous sections of this manual. This includes inspections, danger zones, loading and unloading, vehicle orientation, emergency exits and evacuations, post-crash procedures, and railroad crossings. This section will cover some of the other aspects of driving a school bus in Nevada that have not previously been covered in detail.



Qualifications For School Bus Drivers

Federal regulations require that you must be qualified to drive a Commercial Motor Vehicle. Your employer cannot require or permit you to drive a CMV unless you are considered qualified.

School Bus Driver Responsibilities

School bus drivers have additional responsibilities that include:

- 1) Being familiar with and abide by all federal, state and school rules, policies, and procedures that affect student transportation.
- 2) Report to work with a professional attitude, emotionally and physically prepared to transport students.

- 3) Recognizing the importance of establishing appropriate rapport with students, parents, their supervisors, and school, or central administrators to ensure proper student management.
- 4) Instructing students and demonstrating safe and appropriate behavior, consequences of improper behavior, general procedures, seat belt use and proper adjustment, evacuation drills, and safe travel practices.
- 5) Maintaining order, safety, and protecting the rights of others on the school bus.
- 6) Exercise good judgment and using appropriate verbal intervention. This includes, but is not limited to, the following:
 - a) Minimizing interior noise;
 - b) Controlling passenger movement;
 - c) Requiring an orderly entrance and exit;
 - d) Eliminating movement or potential movement of objects; and
 - e) Requiring silence at railroad crossings.
- 7) Prohibiting transportation of unauthorized materials.
- 8) Handle minor infractions with school approved, on-board consequences, and discussions approved by the school district or agency head.
- 9) In instances of serious or recurring misconduct, follow school policies pertaining to misconduct, submit written reports on appropriate forms to the administrator, and your supervisor or the designated authority who can deal with discipline problems.
- 10) Represent your school by presenting a positive image in dress, language, and manner while on duty, including when you are off duty.
- 11) The school bus driver making a planned and systematic inspection of the bus before each route and/or trip, or to assure that the inspection has been completed properly, and in a timely manner.
- 12) Know federal rules and regulations on confidentiality, including the Health Insurance Portability and Accountability Act (HIPAA), Family Educational Rights and Privacy Act (FERPA), the Americans with Disabilities Act (ADA), Individuals with Disabilities Education Act (IDEA), and state Mandatory Reporting laws ([National School Transportation Specifications & Procedures, 2015](#), pg. 138).
- 13) Be considerate and patient with all children, especially the young or special needs student.
- 14) Always keep the bus clean, including route, and extra-curricular trips.
- 15) It is highly recommended that you keep a daily log of events.
- 16) Monitor, supervise children with appropriate management, and discipline of disruptive pupils who threaten the safety of other students.
- 17) Never allow unauthorized people to board or enter your school bus.

Additional Nevada Requirements



In addition to federal requirements, Nevada school bus drivers must:

- 1) Be of good, reputable, and sober character.
- 2) Be competent, qualified by experience, attitude, and disposition.
- 3) Have GOOD PERSONAL HYGIENE, and dress in an appropriate manner according to your school's policy.
- 4) Be physically qualified and able to perform all duties required of a school bus driver, as required by your school.
- 5) Successfully complete a state approved training course which includes at least 20 hours of training while operating a school bus, and at least 20 hours of classroom training that must include:
 - a) The responsibilities of drivers;
 - b) The requirements for drivers of school vehicles;
 - c) The appropriate management and discipline of disruptive pupils who threaten the

safety of other pupils or the driver while riding in a school bus or at the school bus stop;

- d) The laws affecting the operation of a school bus or vehicle belonging to a school;
- e) Defensive driving;
- f) Emergency procedures; and
- g) First aid and CPR training ([Nevada Revised Statute 386.825](#)).

Note: School bus driver training must be conducted by a Nevada State Certified School Bus Driver Trainer ([Nevada Administrative Code 386.530](#)).

- 1) Conduct pre, post, and anytime the bus is left unattended inspections.
- 2) Pass the State of Nevada School Bus Driver Written Examination with a score of 80% or higher each year annually ([Nevada Administrative Code 386.510](#)).

Each school has the authority to develop policies and procedures that exceed state and federal requirements.

School Bus Driver Duties

School bus drivers have additional duties that include:

- 1) Refraining from the use of stimulants, sedatives, and alcoholic beverages.
- 2) Being responsible for the safe operating condition, and cleanliness of the bus.
- 3) Only using the school bus to transport students on established routes, and schedules approved by your school.
- 4) Never allowing someone else to drive the school bus without the proper licenses, and prior school approval.
- 5) Never allowing unauthorized people to enter your bus.
- 6) Being responsible for any traffic tickets and fines you receive while driving a school bus for a school.
- 7) Reporting any and all bus crashes or incidents that occur in the bus, regardless of damage.
- 8) Be familiar with written instructions of the assigned route that would include any existing railroad crossing, and any fixed route hazard(s).
- 9) Having a planned and systematic inspection of the bus before each route and/or trip. This requires both a stationary and operating inspection during the pre-trip, post-trip, and anytime the bus has been left unattended inspections. Report any needed repair.
- 10) Assuring that all students are able to cross the road safely.
- 11) Keeping accurate school bus inspection logs and submitting all reports when required.
- 12) Conducting the required emergency evacuation drills for regular and special

education students twice yearly.

- 13) Not dropping a student off anywhere other than their scheduled drop off point without prior approval from your school.
- 14) Being familiar with assigned routes and designated school bus stops; Maintain a clean bus, including all route and extra- curricular activities.
- 15) Always having a positive attitude!

Other Duties as Assigned

The COVID-19 Pandemic challenged our communities in ways we had not imagined were possible. With students attending school virtually and communities shut down, our pupil transportation departments and school bus drivers reinvented what it meant to serve our students. Drivers across the state were delivering homework, meals, and Wi-Fi hotspots to students. Teachers were boarding buses to help out and get a chance to see some of their students in person, albeit from a distance. Across the county, school bus drivers were helping to disinfect school buildings, make deliveries, and support families through this trying time. As a school bus driver, you become a vital piece of the infrastructure of your local community and may find your responsibilities and job description adapting to your community's needs.

Required Knowledge and Skills Required Knowledge

School bus drivers are required to have basic knowledge in the following areas: [Federal Motor Carrier Safety Regulation 383.111, Required Knowledge](#)

Safe operations regulations:

- 1) Drivers are required to have the following knowledge:
 - a) Inspection, repair, and maintenance requirements.
 - b) Nevada school bus out-of-service criteria.
 - c) Procedures for safe vehicle operations.
 - d) Effects of fatigue, poor vision, hearing impairment, and general health.
 - e) Effects of alcohol and drug use.
- 2) **Safe vehicle control systems:** Know the purpose and function of the controls, and instruments found in the school bus:
- 3) **Safety control systems.** Proper use of the school bus safety system, including lights, horns, side-view mirrors, rear-view mirrors, proper mirror adjustment, fire extinguisher, symptoms of improper operation revealed through instruments, school bus operational characteristics, and diagnosing malfunctions. Drivers must have knowledge of the correct procedures needed to use safety systems in an emergency situation.
- 4) **Basic control.** The procedures for performing various basic maneuvers:
 - a) Starting, warming up, and shutting down the engine.
 - b) Putting the bus in motion and stopping the bus.

- c) Backing in a straight line.
 - d) Turning the bus, basic rules, off-tracking, right/left turns, and right curves.
- 5) **Shifting.** The basic shifting rules and terms common on Transmissions, including:
- a) Key elements of shifting, e.g., controls, when to shift, and double clutching;
 - b) Shift patterns and procedures;
 - c) Consequences of improper shifting.
- 6) **Backing.** The procedures and rules for various backing maneuvers:
- a) Backing principles and rules; and
 - b) Basic backing maneuvers, e.g., straight-line backing, and backing on a curved path.
- 7) **Visual search.** The importance of proper visual search, and proper visual search methods:
- a) Seeing ahead and to the sides;
 - b) Use of mirrors; and
 - c) Seeing to rear.
- 8) **Communication.** The principles and procedures for proper communications, and the hazards of failure to signal properly.
- a) Signaling your intentions;
 - b) Communicating your presence; and
 - c) Misuse of communications devices.
- 9) **Speed management.** The importance of understanding the effects of speed:
- a) Speed and stopping distance;
 - b) Speed and surface conditions;
 - c) Speed and the shape of the road;
 - d) Speed and visibility; and
 - e) Speed and traffic flow
- 10) **Space management.** Procedures and techniques for controlling the space around your bus:
- a) The importance of space management;
 - b) Space cushions;
 - c) Space to the sides; and
 - d) Space for traffic gaps.
- 11) **Night operation.** Preparations and procedures for driving at night.
- a) Night driving factors such as vision, glare, fatigue, and inexperience.
 - b) Roadway factors such as low illumination, variation in illumination, unfamiliarity

- with roads, and other road users exhibiting erratic or improper driving.
- c) Vehicle factors including headlights, auxiliary lights, turn signals, windshields, and mirrors.
- 12) **Extreme driving conditions.** Basic information on operating in extreme driving conditions:
- a) Bad weather such as snow, ice, sleet, and high winds;
 - b) Hot weather;
 - c) Mountain driving.
- 13) **Hazardous perceptions.** Basic information on hazard perception, and clues for recognizing hazards:
- a) Road characteristics; and
 - b) Road user activities.
- 14) **Emergency maneuvers.** Basic information concerning when and how to make emergency maneuvers:
- a) Evasive steering;
 - b) Emergency stopping;
 - c) Off road recovery;
 - d) Brake failure; and
 - e) Blowouts.
- 15) **Skid control and recovery.** Information on the causes and major types of skids as well as the procedures for recovery from skids.
- 16) **Vehicle inspections.** The objectives, and proper procedures for performing school bus inspections.
- a) The importance of periodic inspection, and repair to vehicle safety.
 - b) The effect of undiscovered malfunctions upon safety.
 - c) What safety-related parts to look for when inspecting the school bus such as fluid leaks, interference with visibility, bad tires, wheel and rim defects, braking system defects, steering system defects, suspension system defects, and exhaust system defects.
 - d) Pre-trip, during a trip, post-trip, enroute/roadside inspection procedures.
 - e) Reporting findings.
 - f) Be familiar with Nevada School Bus Out-of-Service Criteria.
- 17) **Mountain driving.** Practices that are important when driving upgrade, and downgrade:
- a) Selecting a safe speed;

- b) Selecting the right gear; and
 - c) Proper braking techniques.
- 18) **Fatigue and awareness.** Practices that are important to staying alert, and safe when driving:
- a) Being prepared to drive;
 - b) What to do when driving to avoid fatigue;
 - c) What to do when sleepy while driving; and
 - d) What to do when becoming ill while driving.
- 19) **Air brakes.** If your school bus is equipped with air brakes, you must have knowledge in the following areas:
- a) General air brake system components, and terminology;
 - b) The dangers of contaminated air supply (dirt, moisture, and oil);
 - c) Implications of severed or disconnected airlines;
 - d) Implications of low air pressure readings;
 - e) Procedures to conduct safe, and accurate pre-trip inspections;
 - f) Automatic fail-safe devices;
 - i) System monitoring devices; and
 - ii) Low pressure warning alarms.
 - g) Procedures for conducting end-route, and post-trip inspections of air-actuated brake systems:
 - i) Ability to detect defects that may cause the system to fail;
 - ii) Tests that indicate the amount of air loss from the braking system within a specified period, with and without the engine running; and

Tests that indicate the pressure levels at which the low air pressure warning devices should activate.

- 1) General operating practices and procedures:
 - a) Proper braking techniques;
 - b) Antilock brakes;
 - c) Emergency stops; and
 - d) Parking brake.

**Driving a school bus is a tremendous
responsibility!**

Required Skills

School bus drivers must also have the following required skills [Federal Motor Carrier Safety Regulation 383.113, Required Skills](#)

- 1) **Inspection skills.** Must possess basic vehicle inspection skills, be able to identify each safety-related part on the vehicle and explain what needs to be inspected.
 - a) Engine Compartment;
 - b) Cab/engine start;
 - c) Steering;
 - d) Suspension;
 - e) Brakes;
 - f) Wheels;
 - g) Side of vehicle;
 - h) Rear of vehicle;
 - i) Special equipment specific to the school bus
- 2) **Air brake equipped buses.** Must demonstrate the following skills with respect to inspection, and operation of airbrakes:
 - a) Locate, verbally identify air brake controls, and monitoring devices.
 - b) Determine that the brake system condition for proper adjustments, that air system connections have been properly made, and secured.
 - c) Inspect the low pressure warning device to ensure that it will activate in emergency situations.
 - d) With the engine running, make sure that the system maintains an adequate supply of compressed air.
 - e) Determine that the required minimum air pressure build up time is acceptable limits, that required alarms, and emergency devices automatically deactivate at the proper pressure level.
 - f) Operationally check the brake system for proper performance.
- 3) **Basic vehicle control skills.** Must demonstrate the following basic motor vehicle control skills for the school bus.
 - a) Ability to start, warm up, and shut down the engine.
 - b) Ability to put the school bus in motion, accelerate smoothly, forward, and backwards.
 - c) Ability to bring the school bus to a smooth stop.
 - d) Ability to back the school bus up in a straight line, check path, and clearance while backing.

- e) Ability to position the school bus to negotiate safely, then make left and right turns.
 - f) Ability to shift as required, select the appropriate gear for speed, and highway conditions; and
 - g) Ability to back along a curved path ([Federal Motor Carrier Safety Regulation 383.113, Required Skills](#)).
- 4) **Safe on-road driving skills.** Be able to demonstrate the following safe on-road driving skills.
- a) Ability to use proper visual search methods.
 - b) Ability to signal appropriately when changing direction in traffic.
 - c) Ability to adjust speed to the condition of the roadway, weather, visibility conditions, traffic conditions, motor vehicle, and driver conditions.
 - d) Ability to choose a safe gap for changing lanes, passing other vehicles, and crossing or entering traffic.
 - e) Ability to position your school bus correctly before and during a turn to prevent other vehicles from passing you on the wrong side as well as to prevent problems caused by off-tracking.
 - f) Ability to maintain a safe following distance depending on the condition of the road, visibility, and vehicle weight.
 - g) Ability to adjust operation of the vehicle to prevailing weather conditions including speed selection, braking, direction changes, and following distance to maintain control.
 - h) Ability to observe the road and the behavior of other motor vehicles, particularly before changing speed and direction ([Federal Motor Carrier Safety Regulation 383.113, Required Skills](#)).

School bus drivers are required to have additional knowledge and skills that are specific to transporting students.

Unit D1.1 Danger Zones and Use of Mirrors

This unit must teach driver-trainees the danger zones that exist around the school bus and the techniques to ensure the safety of those around the bus. These techniques include correct mirror adjustment and usage. The types of mirrors and their use must be discussed, as well as the requirements found in Federal Motor Vehicle Safety Standard (FMVSS) 111 ([49 CFR 571.111](#)). Training providers must teach driver-trainees the dangers of “dart-outs.” Training providers must teach driver-trainees the importance of training students how to keep out of the danger zone when around school buses and the techniques for doing so.

Danger Zones

The danger zone is the area on all sides of the bus where children are in the most danger of being hit, either by another vehicle or their own bus. The danger zones may extend as much as 30 feet from the front bumper with the first 10 feet being the most dangerous, 10 feet from the left and right sides of the bus and 10 feet behind the rear bumper of the school bus. In addition, the area to the left of the bus is always considered dangerous because of passing cars.

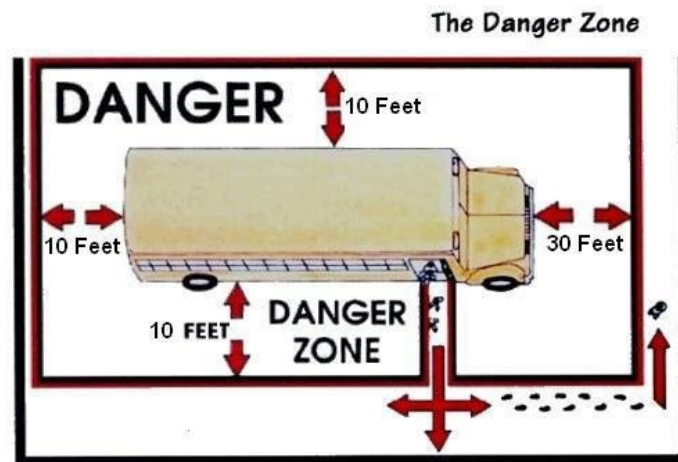

Correct mirror adjustment. Proper adjustment and use of all mirrors is vital to the safe operation of the school bus in order to observe the danger zone around the bus and look for students, traffic, and other objects in this area. You should always check each mirror before operating the school bus to obtain maximum viewing area. If necessary, have the mirrors adjusted ([Nevada Commercial Driver License Manual](#), pg. 10-1).

THE DANGER ZONES

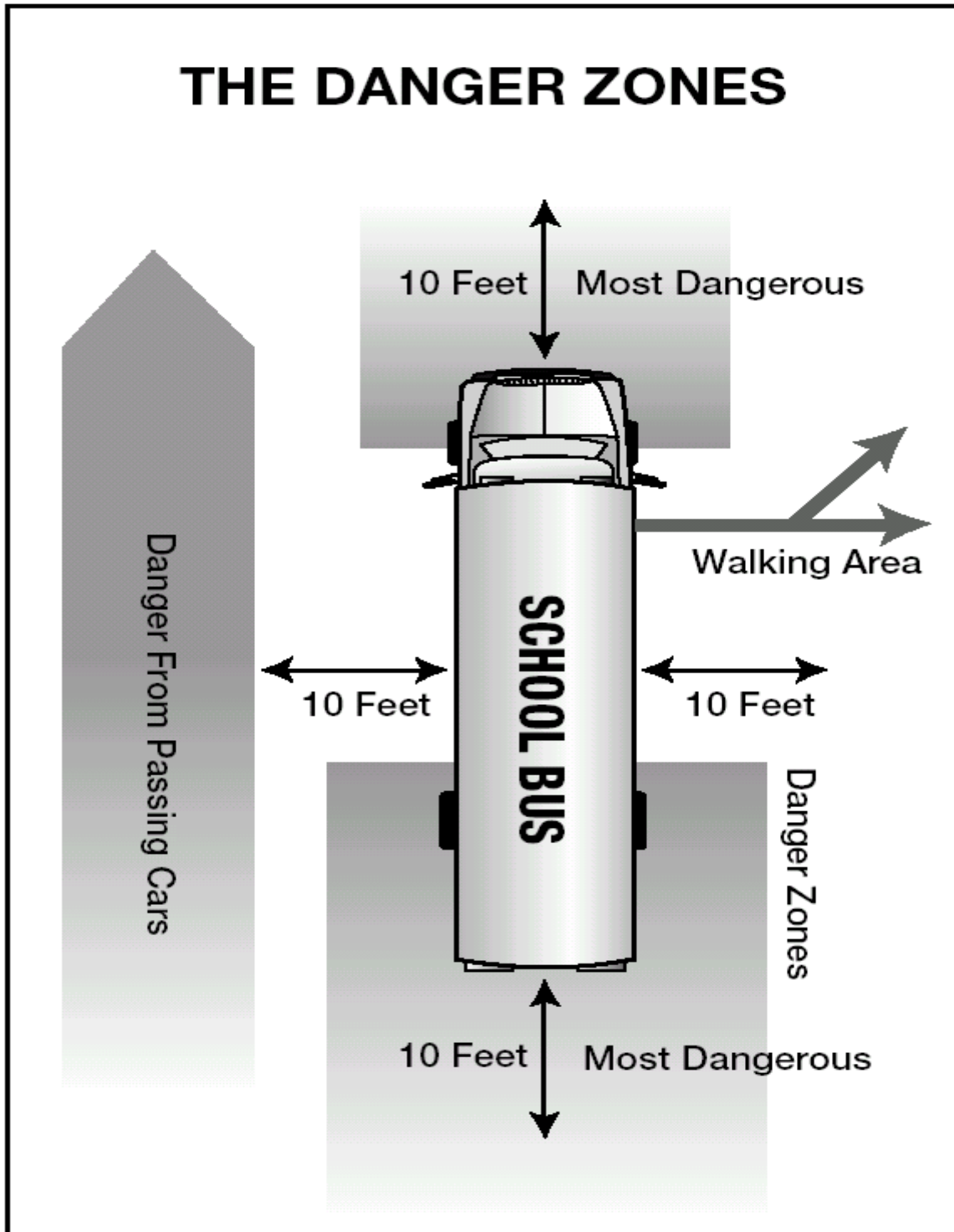

Mirror Use and Adjustment

Proper adjustment and use of all mirrors are very important to the safe operation of the school bus in order to observe the danger zone around the bus and look for students, traffic, and other objects. One of the most important safe driving skills is proper mirror adjustment. Most crashes are the result of improper mirror usage.

Types of Mirrors on School Buses

Flat mirrors. These mirrors are mounted at the left and right front corners of the bus at the side or front of the windshield. They are used to monitor traffic, check clearances and students on the sides and to the rear of the bus. There is a blind spot behind the bus that extends 50 to 150 feet and could extend up to 400 feet depending on the length and width of the bus.

The blind spot is immediately below and in front of each mirror. The blind spot behind the bus extends 50 to 150 feet. Ensure that the mirrors are properly adjusted so you can see:

- 1) 200 feet or 4 bus lengths behind the bus;
- 2) Along the sides of the bus; and
- 3) The rear tires touching the ground ([Nevada Commercial Driver License Manual](#), pg. 10-1).

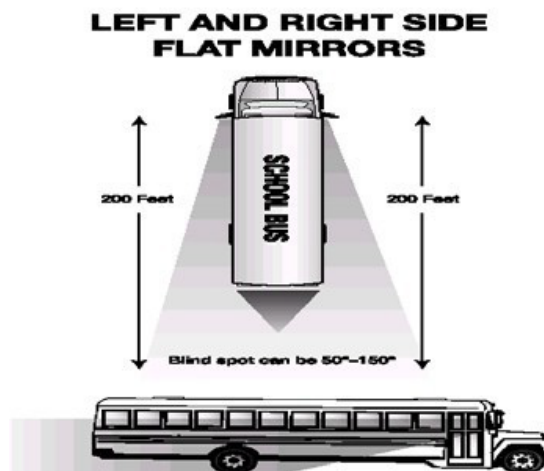

Convex mirrors. Convex mirrors are located below the outside flat mirrors. They are used to monitor the left and right sides at a wide angle. They provide a view of traffic, clearances, and students at the side of the bus. These mirrors give a view of people and objects that does not accurately reflect their size and distance from the bus.

Convex mirrors give a distorted view that does not accurately reflect size or distance from the bus. You should position your mirrors to see:

- 1) The entire side of the bus up to the mirror mounts;
- 2) Front of the rear tires touching the ground; and
- 3) At least one traffic lane on either side of the bus ([Nevada Commercial Driver Manual](#), pg. 10-2).

LEFT AND RIGHT SIDE CONVEX MIRRORS

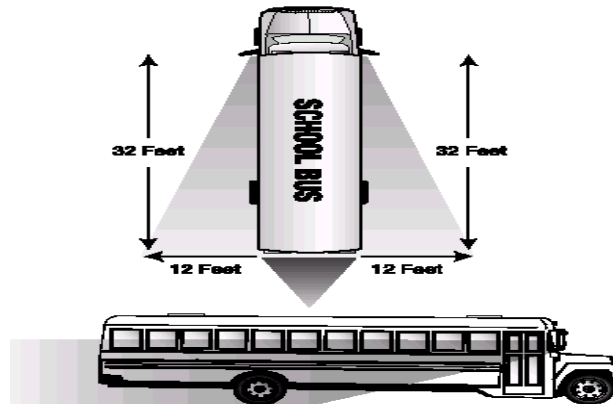

Crossover mirrors. These mirrors are mounted on both the left and right front corners of the bus. They are used to see the front bumper “danger zone” area directly in front of the bus that is not visible by direct vision, and to view the “danger zone” area to the left and right side of the bus, including the service front wheel area.

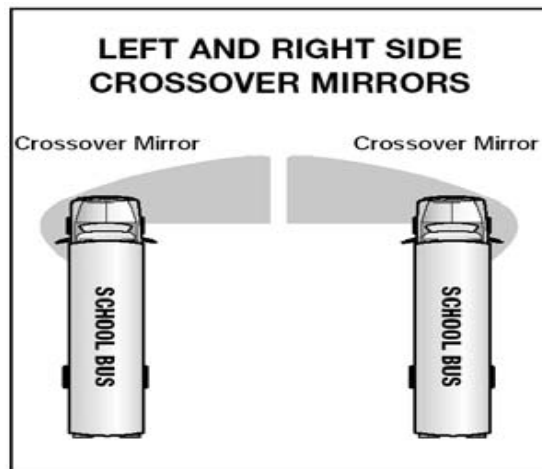

Overhead Inside Rearview Mirror. This mirror is mounted directly above the windshield on the driver’s side area of the bus. This mirror is used to monitor passenger activity inside the bus. It may provide limited visibility directly in back of the bus if the bus is equipped with a glass-bottom rear emergency door. There is a blind spot area directly behind the driver’s seat as well as a large blind spot area that begins at the rear bumper and could extend up to 400 feet or more behind the bus. You must use the exterior side mirrors to monitor traffic that approaches and enters this area.

You should position the mirror to see:

- The top of the rear window in the top of the mirror; and
- All of the students, including the heads of the students right behind you.



Using Your Mirrors

Proper adjustment and use of all mirrors is very important to the safe operation of the school bus in order to observe the danger zone around the bus and look for students, traffic, and other objects. One of the most important safe driving skills is proper mirror adjustment. Most crashes are the result of improper mirror usage.

Five-Count Mirror Check.

Proper mirror use is one of the most important safety factors to safe driving. When checking your mirrors, you need to use the 5-count mirror check. This system of checking your mirrors needs to become automatic. When conducting a 5-count mirror check, start and end on the traffic side.

- a) **Count 1** - Starting on the traffic side, check the mirrors;
 - b) **Count 2** - Check the overhead rear view mirror;
 - c) **Count 3** – Check the opposite mirrors;
 - d) **Count 4** – Check the overhead rear view mirror; and
 - e) **Count 5** – Check the mirrors on the traffic side.
- 2) Include the front cross-view mirrors anytime students are anywhere near the bus.

When checking mirrors, it is important to move your body (rock back and forth) to help you see in your blind spots.

Developing Good Mirror Use

- 1) Before starting out from any stop, be sure to check all mirrors, using the 5-count mirror check. Make sure to check for traffic, pupils, (on and off the bus), pedestrians and bicycles – anything! Know what’s happening around you before you move.
- 2) Mirrors are essential to use before and during all turns. Check traffic and back swing clearance before turning.
- 3) As a school bus driver, you will find that you will be using mirrors more than in your car. The easiest way to learn good mirror use is to set a pattern so it will become habit.

Dart outs

Children may dart out or step into traffic unexpectedly in a rush to get home or just disregard for traffic. This can be exceptionally dangerous as motorists may often ignore control arms.

Techniques and safety

As other motorists can be hard to predict it is important to train the students safety techniques to keep them safe. The next unit discusses loading and unloading with techniques and procedures such as teaching children to never dart into the road and to make eye contact and follow your prompt before crossing.

Unit D1.2 Loading and Unloading

This unit must instruct driver-trainees on the laws and regulations for loading and unloading, as well as the required procedures for students waiting at a bus stop and crossing the roadway at a bus stop. Special dangers involved in loading and unloading must be specifically discussed, including procedures to ensure the danger zone is clear and that no student has been caught in the doorway prior to moving the vehicle. Instruction also must be included on the proper use of lights, stop arms, crossing gates, and safe operation of the door during loading and unloading; the risks involved with leaving students unattended on a school bus; and the proper techniques for checking the bus for sleeping children and lost items at the end of each route.

DANGER ZONE

The loading and unloading zone around the school bus is the most dangerous spot for children. Fatalities continue to occur at and around the bus stop.

The area surrounding the school bus is known as the **Danger Zone** because it is the area where children are in the most danger of being hit, either by another vehicle or their own bus. Although there is no federally mandated danger zone, in Nevada the danger zone is defined as extending **at least 10 feet around the bus**.

The danger zone is the area on all sides of the bus where **children are in the most danger** of being hit, either by another vehicle or the school bus. The danger zones may extend as much as **30 feet** from the front bumper with the first **10 feet** being the most dangerous, **10 feet** from the left and right sides of the bus and **10 feet** behind the rear bumper of the school bus. In addition, the area to the left of the bus is always considered dangerous because of passing cars ([Nevada Commercial Driver License Manual](#), pg. 10-1).

As a school bus driver, it is your responsibility to educate your students of the dangers surrounding the bus and where it is safe for them to walk.

You will have to constantly remind your students, especially the younger students and some students with disabilities.

The **danger zone** extends as much as **30 feet** from the front bumper with the first **10 feet being the most dangerous**.

The Loading and Unloading Zone

Loading and unloading students is the most dangerous time for school bus drivers and students.

More students are killed while getting on or off a school bus each year than are killed as passengers inside of a school bus. As a result, knowing what to do before, during, and after loading or unloading students is critical ([Nevada Commercial Driver License Manual](#), pg. 10-3).

In the school year 2016-2017 there were 8 fatalities in the loading and unloading zone.

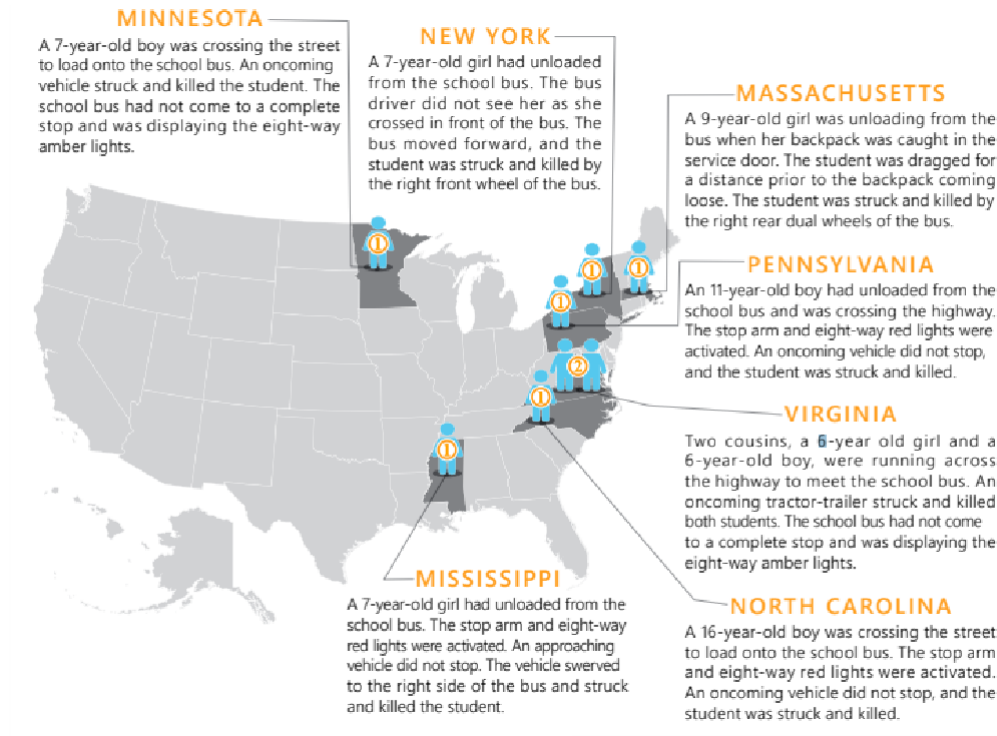

Illegal Passing of The School Bus

School buses have a system of yellow/amber lights to warn motorists that the school bus is getting ready to stop to load or unload children. Illegal passing of a stopped school bus is one of the biggest problems school bus drivers encounter.

Illegal Passing Statistics

Illegal passing of school buses continues to be a significant danger for students. The National Association of State Directors of Pupil Transportation Services (NASDPTS) has been requesting school bus drivers across the country count the number of vehicles that illegally passed their school bus on a single day.

In 2018, 39 states reported 106,383 drivers who illegally passed a stopped school bus with only about 20% of school bus drivers reporting nationally, it is estimated that there are over 15 million violations per day ([National Association of State Directors of Pupil Transportation, Stop Arm Survey](#)).

In Nevada, 744 school bus drivers reported 1,188 stop arm violations on a single day!

When Passing Vehicles are Required to Stop

- 1) Any driver of a vehicle, when meeting, from either direction, a school bus whose system of red flashing lights and crossing arm have been activated, shall bring his vehicle to an immediate stop, and shall not proceed until the school bus has turned off the system of flashing lights and crossing arm.

- 2) A vehicle on a divided highway need not stop when meeting a school bus on the opposite side of the road.
- 3) A vehicle need not stop upon meeting or passing a school bus where traffic is controlled by a traffic officer ([Nevada Revised Statute 484B.353](#)).

Penalties for Stop Arm Violations

Anyone found guilty of a stop arm violation will be convicted of a misdemeanor. For the first offense you will be fined between \$250.00 and \$500.00, for a second offense you will be fined \$250.00 to \$500.00 and your license will be suspended for 6 months. For a third offense, you will be fined not more than \$1,000.00 and your license will be suspended for one year ([Nevada Revised Statute 484B.353](#)).

It is illegal for school bus drivers to pass other school buses that are stopped, with stop arms activated, who are loading and unloading students (except on divided highways with physical barriers)!

[Nevada Revised Statute 484B.363](#)

Report by a School Bus Driver of a Stop Arm Violation

The driver of a school bus who observes a stop arm violation may prepare a report of the violation. The report must be signed by the driver and include:

- 1) The date, time, and approximate location of the violation;
- 2) The number and state of issuance of the license plate of the vehicle; and
- 3) An identification of the vehicle by type and color ([Nevada Revised Statute 484B.357](#)).

System of Lights, Stop Arms and Crossing Control Arm

Every school bus must be equipped with a system of alternating flashing amber lights, alternating flashing red lights, stop arms and a crossing control arm.

Alternating Flashing Amber/Yellow Lights

- 1) Are used to warn drivers that the school bus is planning to stop.
- 2) There are two in the front and two in the rear, visible up to 500 feet.
- 3) Is activated at least 200 feet in advance of the stop by the driver.
- 4) Is deactivated by the driver once the bus is stopped and the door is opened and the alternating flashing red lights, stop arms and crossing control arm are activated.

Alternating Flashing Red Lights, Stop Arms and Crossing Control Arm

[Nevada Revised Statute 386.840](#)

- 1) Flashing red lights, stop arms and crossing control arm are to be activated once the bus

has come to a complete stop.

- 2) The flashing red lights, crossing arm and stop arms are only to be used for loading and unloading students and at times of emergency.
- 3) The use of the crossing control arm **is not** required when the **school bus is solely** used to transport students with special needs who are individually loaded and unloaded and are not required to walk in front of the bus.



School Zones and School Crossing Zones

School Zones

- 1) School zones are sections of street which are adjacent to school property ([Nevada Revised Statute 484B.063](#)).
- 2) A person shall not drive a motor vehicle at a speed in excess of 15 mph in an area designated as a school zone except:
 - a) On a day when school is not in session;
 - b) During the period from a half hour after school is out to a half hour before school is to start; or
- 3) If the zone is designated by an operational speed limit beacon, and the yellow lights are not flashing in the manner which indicates that the speed limit is in effect.



School Crossing Zones

School crossing zones are the section of streets **not** adjacent to school property that pupils cross while following a designated walking route to school ([Nevada Revised Statute 484B.060](#)).

A person shall not drive a motor vehicle at a speed in excess of 25 miles per hour in a designated

school crossing zone except:

- 1) On a day when school is not in session;
- 2) During the period from a half hour after school is out to a half hour before school is to start; or
- 3) If the zone is designated by an operational speed limit beacon, and the yellow lights are not flashing in the manner which indicates that the speed limit is in effect ([Nevada Revised Statute 484B.363](#)).

U-turns and Passing in a School Zone or School Crossing Zone

The driver of a vehicle shall not make a **U-turn** in an area designated as a school zone or school crossing zone; and shall not **overtake and pass** another vehicle or school bus traveling in the same direction in an area designated as a school zone or school crossing zone, except:

- 1) On a day when school is not in session;
- 2) During the period from a half hour after school is out to a half hour before school is to start; or
- 3) If the zone is designated by an operational speed limit beacon, and the yellow lights are not flashing in the manner which indicates that the speed limit is in effect ([Nevada Revised Statute 484B.363](#)).

Move-Over Laws

- 1) The incidents of law enforcement and emergency medical services, fire department personnel and people working on the road are being struck while performing duties at the roadside are increasing at a frightening pace. Move-over laws have been enacted, which require drivers to slow and change lanes when approaching a roadside incident or emergency vehicle ([Nevada Commercial Driver License Manual](#), pg. 2-18).
- 2) When approaching any traffic incident, the driver of the approaching vehicle shall, in the absence of other directions given by a law enforcement officer shall:
 - a) Decrease your speed;
 - b) Be prepared to stop;
 - c) If possible, drive in a lane that is not adjacent to the lane or lanes where the traffic incident is located; and;
 - d) A traffic incident means any vehicle, person, conditions, or other traffic hazard which is located on or near a roadway and which poses a danger to the flow of traffic or to a person involved in, responding to, or assisting with a traffic hazard ([Nevada Revised Statute 484B.607](#)). This includes:
 - i) Emergency vehicles;
 - ii) Towing vehicles;
 - iii) Public Utility vehicles;

- iv) Governmental agencies;
- v) Vehicles using their flashing warning lights;
- vi) A crash scene;
- vii) A stalled vehicle;
- viii) Debris in the roadway; or
- ix) A person who is out of his or her vehicle attending to a repair.

Loading and Unloading Procedures

Each school district establishes official routes and official school bus stops. All stops must be approved by your school district prior to making the stop ([Nevada Revised Statute 386.790](#) and [Nevada Commercial Driver License Manual](#), pg. 10-3).

You **cannot** change the location of a bus stop without written approval from your supervisor.

You must use extreme caution when approaching a school bus stop. You are in a very demanding situation when entering these areas. It is critical that you understand and follow all state and local laws and regulations regarding approaching a school bus stop. This would involve the proper use of mirrors, alternating flashing lights, stop signal arm, and crossing control arm ([Nevada Commercial Driver License Manual](#), pg. 10-3).



Approaching the Stop

- 1) Activate your turn signal, 100 feet in residential and 300 feet on highways and get into the right lane far in advance of the stop.
- 2) Approach the stop cautiously at a slow rate of speed.
- 3) Look for pedestrians, traffic, or other objects before, during and after coming to a stop.
- 4) Continuously check all mirrors by doing a 5-count mirror check.
- 5) Activate alternating flashing student amber/yellow lights at least 200 feet or approximately 3-5 seconds before the stop.
- 6) Turn on right turn signal about 100 feet or approximately 3-5 seconds before pulling over.
- 7) Continuously check all mirrors by doing a 5-count mirror check to monitor the danger zones for students, traffic, and other objects.

- 8) Stay to the right side of the roadway in the traffic lane, not on the shoulder, when loading and unloading. Do not try to block traffic.
- 9) Stop before you get to the students. Make them walk to you so you can see them ([Nevada Commercial Driver License Manual](#), pg. 10-3).
- 10) Never pull into a group of students hanging around the curb or in the street. Stay back and wait for the students to clear the loading zone before you pull in.

When Stopping

[Nevada Commercial Driver License Manual](#), (pg. 10-3)

- 1) Bring the school bus to a full stop with the front bumper at least 10 feet away from students at the designated stop. This forces the students to walk to the bus so you have a better view of their movements.
- 2) Place transmission in Park, or if there is no park shift point, in Neutral and set the parking brake at each stop.
- 3) Activate alternating red lights or open the door when traffic is a safe distance from the school bus and ensure stop arm is extended.

When in doubt, check it out!

Loading Procedures

[Nevada Commercial Driver License Manual](#), (pg. 10-4)

- 1) Make sure all passing vehicles have stopped. Before completely opening the door and signaling students to approach.
- 2) Train students to wait in a designated location for the school bus, facing the bus as it approaches.
- 3) Students should board the bus only when signaled by the driver.
- 4) Monitor all mirrors continuously using the 5-count mirror check.
- 5) Count the number of students at the bus stop and check to make sure the same number board the bus. If possible, know names of students at each stop. If a student is missing, ask the other students where the student is.
- 6) Have students board the bus slowly, in single file, and use the handrail. The dome light should be on while loading in the dark.
- 7) Wait until students are seated and facing before moving the bus.
- 8) Check your mirrors, using the 5-count mirror check. Make certain no one is running to catch the bus.
- 9) If you cannot account for a student outside, secure the bus, activate hazards if your student loading lights do not operate when you take the key, and check around and underneath the bus after all students have loaded.

- 10) As student board the bus, remind them to buckle up if bus equipped with lap/shoulder belts
- 11) Students must be seated entirely within the confines of the school bus seat compartment. In order to protect children, they must be fully seated within the compartment and cannot be sitting sideways or in the aisle ([National Highway Traffic Safety Administration, Number of Persons that Can Sit on a School Bus Seat](#)).
- 12) When all students are accounted for, prepare to leave by:
 - a) Engaging the transmission;
 - b) Releasing the parking brake;
 - c) Close the door, deactivating the alternating flashing red lamps;
 - d) Activate left turn signal;
 - e) Allow traffic to clear;
 - f) Do a 5-count mirror check;
 - g) Allow congested traffic to disperse; and
 - h) When it is safe, move the bus to enter traffic and continue on your route.

**Unloading students is far more dangerous than
loading
them!**

Unloading Procedures

- 1) Activate your turn signal, 100 feet in residential and 300 feet on highways and get into the right lane far in advance of the stop.
- 2) Have the students remain seated until told to exit.
- 3) Approach the stop cautiously at a slow rate of speed.
- 4) Look for pedestrians, traffic, or other objects before, during and after coming to a stop.
- 5) Continuously check all mirrors by doing a 5-count mirror check.
- 6) Turn on right turn signal about 100 feet or approximately 3-5 seconds before pulling over.
- 7) Place transmission in Park, or if there is no park shift point, in Neutral and set the parking brake at each stop.
- 8) Activate alternating red lights or open the door when traffic is a safe distance from the school bus and ensure stop arm is extended.

**A driver's supervision doesn't just start when students
are on the bus!**

- 9) Signal the students when it is safe to stand up and exit the bus. Make sure students exit in an orderly fashion.
- 10) Count the number of students while unloading and confirm the location of all students before pulling away.
- 11) If you cannot account for a student outside the bus, secure the bus, activate hazards if your student loading lights do not operate when you take the key, and check around and underneath the bus after all students have unloaded.
- 12) Continuously check all mirrors by doing a 5-count mirror check ([Nevada Commercial Driver License Manual](#), pg. 10-5).
- 13) Never drop a student off at an unassigned stop.
- 14) At the end of each run, check for hiding/sleeping students or items left behind.



Additional Procedures for Students That Must Cross the Road

You should understand what students should do when exiting a school bus and crossing the street in front of the bus. In addition, the bus driver should understand that students might not always do what they are supposed to do ([Nevada Commercial Driver License Manual](#), pg. 10-4).

- 1) If students must cross the roadway, instruct them to:
 - a) Walk at least 10 feet away from the side of the school bus to a position where you can see them;
 - b) Walk to a location at least 10 feet in front of the right corner of the bumper, but still remaining away from the front of the school bus;
 - c) Count the number of students while unloading to confirm the location of all students; and
 - d) Have students stop at the right edge of the sidewalk/roadway. You should be able to see the student's feet.
- 2) Check all mirrors again by doing a 5-count mirror check.
- 3) When it is safe, and all vehicles have stopped, signal students to cross. By waving your

hand in a sweeping motion. Upon your signal, students need to:

- a) Cross far enough in front of the school bus to be in your view;
- b) Stop at the left edge of the school bus, stop, and look again for your signal to continue to cross the roadway;
- c) Stop at the left edge of the school bus, stop, and look again for your signal to continue to cross the roadway;
- d) Look for traffic in both directions, making sure the roadway is clear; and
- e) Proceed across the roadway, continuing to look in both directions.



- 1) Make sure no students are around or returning to the bus.
- 2) If you cannot account for a student outside the bus, secure the bus, activate hazards if loading lights are not operational, take the keys, get out, and check around and underneath the bus.

Do not signal for students to cross the street unless you are certain all traffic has/will stop for students!

- 3) When all students are accounted for, prepare to leave by:
 - a) Closing the door;
 - b) Engage the transmission;
 - c) Release the parking brake;
 - d) Turn off alternating flashing red lights;
 - e) Turn on your left turn signal;
 - f) Check all mirrors again, using the 5-count mirror check;
 - g) Allow congested traffic to disperse; and
 - h) When it is safe, move the bus, enter the traffic flow, and continue the route.

Loading and Unloading Procedures at School



Unloading students in school parking lots or other locations off the traveled roadway are different than loading along the school bus route. It is important that the school bus drivers understand and obeys state and local laws and regulations.

- 1) When unloading at the school you should perform a safe stop as outlined in **Approaching the Stop** and **Unloading Procedures** section above.
- 2) Secure the bus by:
 - a) Turning off the ignition;
 - b) Removing the key if leaving the driver's compartment;
 - c) Have the students remain seated until told to exit;
 - d) Position yourself to supervise unloading;
 - e) Have students exit in an orderly fashion;
 - f) Observe students as they step from the bus to see that all have moved away from the unloading area/danger zone;
 - g) Walk through the bus and check for hiding/sleeping students and items left by students;
 - h) Do a 5-count mirror check. Make certain that no students are returning to the bus; and
 - i) If you cannot account for a student outside the bus, secure the bus and get out and check around and underneath the bus.
- 3) When all students are accounted for, prepare to leave by:
 - a) Closing the door;
 - b) Fastening safety belt;
 - c) Starting engine;
 - d) Engaging the transmission;
 - e) Releasing the parking brake;
 - f) Turning off alternating flashing red lights;
 - g) Activate turn signal;
 - h) Check all mirrors, doing a 5-count mirror check;

- i) Allow congested traffic to disperse; and
- j) When it is safe, pull away from the loading/unloading zone ([Nevada Commercial Driver License Manual](#), pg. 10-5).

Special Dangers in the Loading and Unloading Zone

[Nevada Commercial Driver License Manual](#), (pg. 10-5)

Common hazards during loading and unloading include:

- 1) Dropped or forgotten objects. Always focus on students as they approach the bus and watch for any who disappear from sight.
- 2) Students may drop an object near the bus during loading and unloading and attempt to retrieve the dropped object. Students need to be taught that it is very dangerous, and they need to stay away from the danger zone. Stopping to pick up the object or returning to pick up the object may cause the student to disappear from the driver's sight at a very dangerous moment.
- 3) Students need to be taught that it is very dangerous, and they need to stay away from the danger zone. Instruct students that if they have dropped or forgotten something, they need to get the driver's attention prior to retrieving the object.
- 4) **The school bus handrail hang-ups.** Students have been injured or killed when clothing, accessories, or even parts of their body get caught in the handrail or door as they exit the bus.
- 5) **Schools and school zones.** Children and parents are not watching out for the school bus. Train students not to push or shove when getting on and off the bus. Teach them about the danger zone and why it can be dangerous for students.

**Teach your students to NEVER cross behind
the bus.**

Preventing Incidents in the Loading and Unloading Zone

- 1) **Don't rush**
 - a) This means don't speed.
 - b) Take each stop one at a time.
 - c) Concentrate on what you are doing.
 - d) Don't get lazy and complacent and skip over part of the loading/unloading procedures
- 2) If you are running late on a route, don't hurry. Safe is better than sorry.
- 3) **Safety first, schedule second.**
- 4) **Never move the bus.** If students are in the danger zone, do not move the bus.

- 5) **Don't deal with on-bus problems** when loading or unloading students. Wait until the students have safely loaded or unloaded the bus to handle issues.
- 6) Use a **consistent hand signal** to tell students when it is safe to cross the street. The hand signal should not be confused with a wave because waiting motorists might think you are telling them to pass.
- 7) **NEVER** signal students to cross the street until you have assured all approaching vehicles have stopped!
- 8) Use a consistent **danger signal** that means return to the side of the road you started from **AT ONCE!**
- 9) Use the external P.A. system, if you have one, to let students know when it is safe to cross the road.
- 10) **Count and recount.** Know how many students should get **on and off** at each stop.
- 11) As the students get **off** at a bus stop, count them. Then, before you move the bus, count them again as they move away. Don't move until you are sure that they are all away from the bus and safely off the roadway.
- 12) If you can't account for a student outside the bus, secure the bus and check around and underneath the bus.
- 13) **Assume the Worst from Motorists.** Even though they are not supposed to, motorists often pass a stopped school bus. As the school bus driver, you should:
 - a) Constantly check traffic in all directions using the 5-count mirror check;
 - b) Make sure that you give plenty of warning by turning on your yellow flashers early; and
 - c) Don't let students off until you are sure it is safe.
- 14) Watch emergency vehicles closely. Emergency and police ultimately have the right of way. However, most will not proceed until you have turned off your flashers. This tells them that you have heard the siren and it is safe for them to proceed. If you hear a siren, you should:
 - a) Make sure all students are out of the danger zone and then cancel your flashers and deactivate the stop arm; and
 - b) If you hear a siren and students are still on the bus do not allow students off the bus.

Leaving Students on The School Bus

Students are being left on school buses more often than reported. But the consequences can be deadly for the student and traumatic for the bus driver. That is why it's important to develop a routine for checking for students after each run.

Psychology professors indicated it's actually pretty easy to leave kids in cars/buses. That people believe that cognition works better than it actually does. Perception, attention, and memory all have strong limitations ([Kids and Cars.org](http://KidsandCars.org)).

Things like a change in your routine, stress and multiple life factors can distract drivers ([School Bus Fleet Magazine](#)).

Why Students are Left on the Bus

Even good drivers can leave students on the bus. Some of the main reasons that contribute to such incidents are:

- 1) Sudden and stressful situations can push our intentions from our active mind into our subconscious;
- 2) Inattentional blindness, when a driver remembers to do a check of the bus and simply does not see the child;
- 3) Not having your mind on your job at all times;
- 4) Driver fatigue;
- 5) Complacency: “I checked the bus before, and no one has ever been there”;
- 6) “That would never happen to me” mentality; and
- 7) Drivers can be so focused on a task that they entirely miss something unusual, like a sleeping child.

Remember to check under the seats for sleeping students!

Consequences for School Bus Drivers Who Leave Children on the Bus

- 1) Leaving a child on the bus can cause psychological trauma to children.
- 2) Children left on school buses can be injured while escaping from the bus.
- 3) Children can be injured or die due to extreme hot and cold weather.
- 4) Drivers have been terminated after leaving a student on the school bus.
- 5) Child neglect charges.
- 6) Catastrophic change in the life of bus drivers who leave students on the bus.
- 7) Public and personal humiliation.

Once you get back to the bus yard, walk the bus again checking for students.

Steps for Preventing Leaving Students behind

- 1) Constant driver training along with keeping drivers conscious of the dangers of complacency and importance of being vigilant.
- 2) Post reminders in the bus yard to check for students after each trip.

- 3) Have a way to verify that the driver has walked the bus and checked for students. These methods can be as simple as “Empty Bus” placard that must be placed in the back of the bus after the last run to video surveillance and electronic monitors.
- 4) Keeping count of all students that board the bus and make sure the same number have exited the bus.
- 5) Drivers should teach children to use the horn and two- radio system, including how to turn it on, and how to use the emergency exits so that they can get help if they are left on the bus.
- 6) Understand sudden and stressful situations and avoid changes in patterns.
- 7) Avoid being complacent with the attitude that it won’t happen to me. Everyday good parents leave their kids in vehicles by accident.
- 8) Be diligent when checking for students, not just a walk to the back of the bus but checking under seats or areas where children can hide.

Unit D1.3 Vehicle Orientation

This unit must teach driver-trainees the basic physical and operational characteristics of school buses, including overall height, length, width, ground clearances, rear overhang, Gross Vehicle Weight and Gross Vehicle Weight Rating, axle weights, wheels and rims, tires, tire ratings, mirrors, steer wheels, lighting, windshield, windshield wipers, engine compartments, basic electrical system, brake systems, as applicable, and spare tire storage. Additionally, the training providers must instruct driver-trainees in techniques for proper driver seat and mirror adjustments.

Vehicle orientation

A school bus is a bus manufactured to [Federal Motor Vehicle Safety Standard \(FMVSS\) 571](#) of the National Highway Traffic Safety Administration. Most school buses have a yellow body installed upon a chassis with an elevated passenger deck, an engine entirely in front of the windshield, and a single entrance door behind the front wheels. Some large school buses look more like a transit bus with the engine mounted entirely behind the windshield (in the front, middle, or rear of the bus), and a single entrance door ahead of the front wheels. Most small school buses have a conversion or body constructed upon a van-type chassis and meet FMVSS 571.

School Bus Types

School Bus: A bus owned, leased, contracted to, or operated by a school district and regularly used to transport more than 10 passengers/students in addition to the driver to and from school or school-related activities, but not including a charter bus or transit bus. A school bus must meet all applicable laws and is readily identifiable by alternately flashing lamps, National School Bus Yellow paint, and the legend “School Bus,” except as may be provided for the multifunctional school activity bus (MFSAB). The following describes each of these types and styles of vehicle.

Type A: A Type “A” school bus is a conversion or bus constructed utilizing a cutaway front section vehicle with a left side driver’s door. This definition includes two classifications:

Type A-1, with a Gross Vehicle Weight Rating (GVWR) of 14,500 pounds or less; and

Type A-2, with a GVWR greater than 14,500 and less than or equal to 21,500 pounds.



Type B: A Type “B” school bus is constructed utilizing a stripped chassis. The entrance door is behind the front wheels. This definition includes two classifications:

Type B-1, with a GVWR of 10,000 pounds or less; and

Type B-2, with a GVWR greater than 10,000 pounds.



Type C: A Type “C” school bus is constructed utilizing a chassis with a hood and front fender assembly. The entrance door is behind the front wheels; also known as a *conventional school bus*. This type also includes cutaway truck chassis or truck chassis with cab with or without left side door and a GVWR greater than 21,500 pounds.



Type D: A Type “D” school bus is constructed utilizing a stripped chassis. The entrance door is ahead of the front wheels; also known as *rear engine transit style school buses*.



Multifunctional school activity bus (MFSAB): A school bus whose purposes do not include transporting students to and from home or school bus stops, as defined in [Federal Motor Vehicle Safety Standard 571.3, Definitions](#). This subcategory of school bus meets all Federal Motor Vehicle Safety Standards for school buses except the traffic control requirements (alternately flashing signal and stop arm).

Seat and mirror adjustment

A driver should always maintain proper seat and mirror adjustment that allows for quick checks without having to shift or reposition their body.

Compartmentalization vs. Seat Belts in School Buses

Compartmentalization in school buses is the design concept of using tall seat backs, padded with energy-absorbing construction covering all metal parts, and spacing that is closer than typically found in passenger vehicles.

Previously, it was believed that compartmentalization alone was sufficient to protect students in the event of an accident. Over the years various organizations and government agencies have studied the efficacy of compartmentalization alone versus the addition of safety belts. This new information has led to a number of states, including Nevada, to require seat belts in new buses ([NRS 386.837](#)).

Unit D1.4 Post-Crash Procedures

This unit must instruct driver-trainees on the proper procedures following a school bus crash. The instruction must include use of fire extinguisher(s), first aid kit(s), tending to injured passengers, post-crash vehicle securement, notification procedures, deciding whether to evacuate the bus, data gathering, and interaction with law enforcement officials.

Post-Crash Procedures

This unit was discussed above in [Unit 1.5.5 Post-Crash Procedures](#) for a class B CDL. Same procedures apply.

Proper Use of Safety Components

Every school bus in Nevada is required to carry the following emergency equipment:

Alternating Flashing Yellow and Red Lights



Every school bus operated for the transportation of pupils to and from school must be equipped with a system of alternating flashing yellow/red lights that the driver shall operate when the bus is preparing to stop and when it has stopped to load/unload pupils, and in times of an emergency or crash ([Nevada Revised Statute 386.840](#)).

Belt Cutters

Each school bus which transports students in a wheelchair or other assistive restraint devices that utilize belts, or any school bus equipped with passenger restraint systems shall contain at least two belt cutters secured in a location within reach of the driver while belted into his/her driver's seat.

First Aid Kit

Each school bus must have a sealed, removable, moisture-proof First Aid Kit in an accessible place in the driver's compartment. It shall be mounted and identified with one-inch letters as a First Aid Kit. If stored in a compartment, the compartment must be clearly labeled, easily accessible to the driver and not blocked.

Minimum Contents include:

- 2 1-inch x 2 ½ yards of adhesive tape rolls
- 24 Sterile gauze pads 3 x 3
- 50 ¾ x 3 inches adhesive bandages
- 8 2-inch bandage compress
- 10 3-inch bandage compress
- 2 2-inch x 6-foot sterile gauze roller bandages
- 2 Non-sterile triangular bandages, minimum 39x35x54 inches with two safety pins
- 2 Sterile gauze pads 36 x 36 inches
- 3 Sterile eye pads
- 1 rounded-end scissors
- 1 Pair medical grade examination gloves
- 1 mouth-to-mouth airway

**Extra bandages should be kept separate
from the First Aid Kit.**

First Steps in Providing First Aid

As a bus driver, you can be required to provide first-aid to pupils who can have a range of injuries. Always contact 911 for any emergency or serious injury.

For minor injuries, provide first aid as required. All school bus drivers are required to have training in emergency procedures and first aid ([Nevada Revised Statute 386.825](#)).

Basic First Aid

- 1) Applies only to immediate temporary need;
- 2) You are not expected to be a medical doctor and minimal first aid should be administered;
- 3) Follow only school district approved first-aid procedures and your training; and
- 4) Remain calm!

Body Fluid Clean-Up Kit

Each school bus shall have a sealed, removable, moisture-proof Body Fluid Clean-Up Kit accessible to the driver, securely mounted and labeled. If located in a compartment, the compartment must be clearly labeled in one-inch letters, be easily accessible to the driver and not blocked.

The Body Fluid Clean-Up Kit shall be a minimum 10-unit kit that is OSHA/ANSI Compliant.

Minimum contents include:

- 1 Absorbent powder
- 1 Disinfectant cloth
- 1 Scoop and spatula
- 2 Pair - medical grade gloves

- 10 Paper towels
- 1 Biohazard bag
- 1 Personal protective apparel pack
- 1 Large gown

**Your school bus can be placed out-of- service if the
First Aid and Body Fluid Clean-Up Kits are
blocked when stored in an overhead compartment!**

Kit Seals

First aid and blood born pathogen kits must be sealed and dated. It is the driver's responsibility when using kits to refill and reseal the kit.

Bloodborne Pathogens

Bloodborne pathogens are infectious microorganisms in human blood that can cause disease in humans. These pathogens include, but are not limited to, hepatitis B (HBV), hepatitis C (HCV) and human immunodeficiency virus (HIV). Needlesticks and other sharps-related injuries may expose workers to bloodborne pathogens. The most common way for bloodborne pathogens to spread at work is through open wounds, making proper bandaging a very important part of both driver and student safety. [OSHA: Bloodborne Pathogens](#)

Universal Precautions

Originally recommended by the CDC in the 1980s, Universal Precautions (UP) was introduced as an approach to infection control to protect workers from HIV, HBV, and other bloodborne pathogens in human blood and certain other body fluids, regardless of a patient's infection status. UP is an approach to infection control in which all human blood and certain human body fluids are treated as if they are known to be infectious. If you're not sure what kind of body fluid, you are dealing with presume it is blood or Other Potentially Infectious Material (OPIM).

Basic Body Fluid clean-up procedures:

- 1) Move students away from the contaminated area;
- 2) Put on disposable gloves;
- 3) Sprinkle absorbent material over spilled area. Liquid will quickly congeal for safer handling;
- 4) After 1 minute, remove contaminated material with scoop and scraper. Carefully place in discard bag from kit;
- 5) Clean away soils with absorbent towel;
- 6) After the spill is removed, apply disinfectant from the kit;
- 7) Place all contaminated materials (including gloves) in discard bag. Seal and dispose of bag according to your school district policy;
- 8) Wipe hands with anti-microbial hand wipe. Wash with soap and running water as soon as possible; and

- 9) If possible, the student's clothing and other soiled, non-disposable items should be placed in a plastic bag and sent home with the student.

Emergency Warning Devices

Each school bus shall contain at least three (3) reflectorized triangle road-warning devices mounted in an accessible place ([Federal Motor Carrier Safety Regulation 392.22, Emergency Signals, Stopped Commercial Motor Vehicles](#)).

In case of a breakdown, accident or other emergency, the driver, paraprofessional, or qualified individual will place the triangles as the law requires.

When you pull off the road and stop, activate the 4-way hazard lamps. Taillights may not provide adequate warning to motorists. Drivers have crashed into the rear of a parked vehicle because they thought it was moving normally. When placing the triangles, hold an assembled triangle toward the oncoming traffic. This enhances safety by increasing visibility to other drivers, especially at night.

When the triangles are unfolded for use, the weighted base must be turned so it makes a cross with the bottom of the triangle to keep the triangle from tipping over.

If you must stop on a road or shoulder of a road, set your emergency reflective triangles within 10 minutes. Placement should be at the following locations:

- 1) On the traffic side of the vehicle, within 10 feet from the front or rear corners to mark the location of the vehicle.
- 2) About 100 feet behind and ahead of the vehicle, on the shoulder or in the lane you are stopped in.

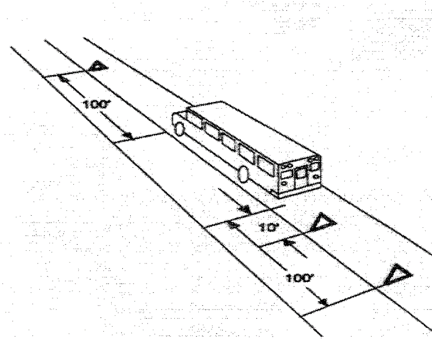

If there is a hill, curve, or other obstruction of the line of sight, move the rearmost triangle further back to give adequate warning.

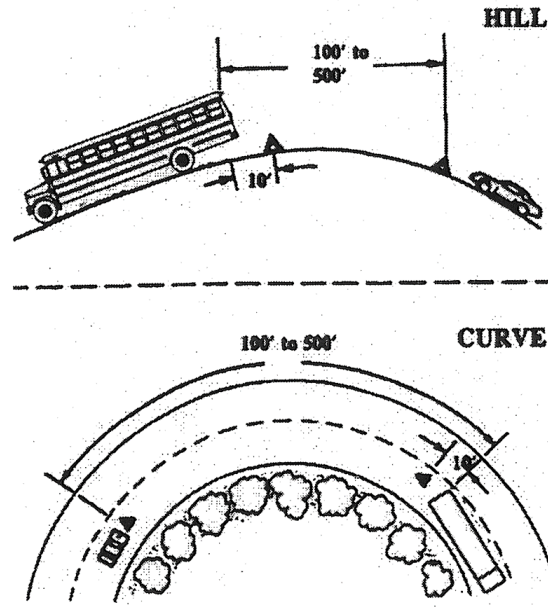

- 3) If stopping on a one-way or divided highway, triangles should be placed at 10 feet, 100 feet, and 200 feet toward approaching traffic.

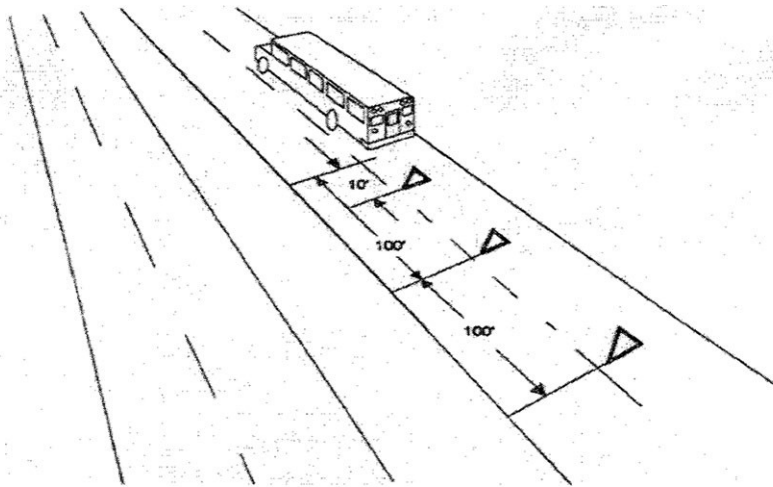

Fire Extinguishers

The school bus shall be equipped with at least one UL-approved pressurized, dry chemical fire extinguisher. The extinguisher shall be secured in a mounted bracket, located in the driver's compartment and readily accessible to the driver and passengers, with a sign indicating the location of such equipment. A pressure gauge shall be mounted on the extinguisher and shall be easily read without moving the extinguisher from its mounted position. The fire extinguisher shall have a rating of 5 B:C, or greater. The operating mechanism shall be secured with a type of seal that will not interfere with the use of the fire extinguisher ([National School Transportation Specifications and Procedures, 2015](#), pg. 38).

Unit D1.5 Emergency Exit and Evacuation

This unit must teach driver-trainees their role in safely evacuating the bus in an emergency and planning for an emergency in advance. Training must include proper evacuation methods and procedures, such as the safe evacuation of students on field and activity trips who only occasionally ride school buses and thus may not be familiar with the procedures.

Planning for Emergencies

An emergency can happen to anyone, anytime, anywhere. It could be a crash, a stalled school bus on a railroad crossing, a high-speed intersection, an electrical fire in the engine compartment or a medical emergency of a student on the school bus. Knowing what to do in an emergency- before, during and after an emergency can mean the difference between life and death ([Nevada Commercial Driver License Manual](#), pg. 10-6).

Drills to Practice Evacuation

Nevada Law requires that you practice the evacuation of a school bus and receive instruction in the responsibility of a passenger of a school bus to use the emergency exit doors on the bus during such an evacuation **at the beginning of any field trip by school bus.**

Instruction should include:

- 1) The responsibility of passengers on a school bus, including where and how to use the emergency exit doors and windows during an evacuation;
- 2) Procedures to safely enter and exit a school bus;
- 3) Appropriate behavior and conduct while on a school bus;
- 4) The location of emergency equipment on a school bus; and [Nevada Revised Statute 386.820](#).
- 5) If chaperones or parents are riding the school bus for the first time, they will need to practice and receive instruction for an emergency evacuation drill.

Planning the Trip

- 1) Plan and follow routes in detail so your school district knows the route you plan to take and the estimated arrival time.
- 2) Check on weather conditions.
- 3) Make sure to know the location where you are going and the location where you are picking up students.
- 4) Be familiar with the bus you are taking and do a thorough pre-trip inspection before leaving.
- 5) Know who your chaperones will be and explain the safety and discipline rules on the bus. Make sure your chaperones participate in the emergency evacuation drill prior to the trip and receive instruction in emergency procedures.

Remember, the bus driver has the final authority and responsibility on the school bus!

- 6) Have a list of passengers that includes names, addresses, date of birth and phone numbers, provided by your school. In the event of a crash, this information will be required.
- 7) Know what type of equipment you will be required to carry. You will need to be sure that you have proper storage space for extra equipment.

Federal law forbids blocking the aisle, door, steps and emergency exits!

- 8) During your trip plan for stops. You should attempt to stop every 2 hours to refuel, allow your students to use the restroom or eat. Every time your passengers leave the bus, arrange a time and place for re-boarding. Make sure to account for all passengers prior to departure.
- 9) Remember the rules for driving in hazardous conditions like rain, heat, snow and check tires and fluids at stops.
- 10) Anytime you leave the bus unattended for any length of time, it is important to do a security inspection of your vehicle. You must walk around the vehicle checking for vandalism, suspicious packages, devices, substances, unattended baggage, tire damage or engine tampering. There is no time requirement for this type of inspection. Anytime the bus is left unattended (no longer in visual sight of the driver) a quick inspection must be done. You are still required to do a full-post trip inspection.
- 11) When doing a security inspection, you need to check the following areas:



- a. Floors;

- b. Seats;
- c. Driver's area;
- d. Steps;
- e. Wheelchair lifts;
- f. Lights;
- g. Wheel wells;
- h. Engine compartments;
- i. Exhaust System;
- j. Fuel and air tanks; and
- k. Back/side emergency exit door(s).

Transportation Security Administration's, School Bus Security

- 1) Be prepared to stop at all inspection stations even though your school bus is inspected by the Nevada Highway Patrol each year. Be prepared to show that you conducted your pre-trip inspection.
- 2) Consider tolls, parking fees or other minor related expenses and who will pay for them.
- 3) Keep a log showing your off-duty, driving and on-duty, not driving time. Check your school district for an approved log sheet.
- 4) Check yourself throughout the trip to make sure you are in safe operating condition.

You are required to keep a student roster, including seating positions of the students.

Emergency Procedures

In an emergency always call 911!



At least twice each school year, schools are required to practice the evacuation of a school bus and receive instruction in the responsibility of a passenger of a school bus to use the emergency exit doors on the bus during an evacuation ([Nevada Revised Statute 386.820](#)).

Emergency Planning for The Trip

Being prepared is the best way to handle an emergency. You will need to:

- 1) Be familiar with your school's safety protocols and communication requirements in the event of an emergency;
- 2) Have a list of emergency phone numbers and contact information;
- 3) Have insurance and vehicle registration in case of a crash;
- 4) Have a blank seating chart;
- 5) Have medical information on students;
- 6) Have evacuation procedures; and
- 7) Know the location of first-aid kit, body-fluid kit, fire extinguisher, emergency exits, belt cutter, and emergency shut-off switches.

Extra Risks with Activity Trips

Field and activity trips pose a greater risk to student safety than to and from school transportation because:

- 1) Drivers are often unfamiliar with the route and the bus;
- 2) Driving speeds are usually higher;
- 3) Trips often take place at night where visibility is less;
- 4) There is a greater risk of fatigue;
- 5) Students may not be regular riders and may be unfamiliar with the bus and the rules for students; and
- 6) Students and chaperones can be distracted by the excitement of the event or competition they are attending.

Parent and Teacher Chaperones

Ensure that any chaperones understand what their responsibilities are according to your district or school policy.

Emergency Evacuation Plan

Every school bus driver who has students with special needs need to think about how to evacuate those students ([National Highway Traffic Safety Administration, Emergency Situations](#)).

When preparing the evacuation plan consider the following:

- 1) Which students can come off the school bus by themselves;
- 2) Which students can help other students off the school bus;
- 3) Which students can be removed from the bus without their wheelchair or specialized seat or child safety seat;
- 4) Which students must not be removed from their wheelchair or specialized seat or child safety seat;
- 5) Which students have essential equipment that also must be removed;
- 6) What equipment do you need for an evacuation (belt cutter, fire blanket, first-aid kit, body fluid clean-up kit,); and
- 7) Where are emergency services along your route (fire stations, hospitals, police).

General Rules on How to Handle an Emergency

Here are some general rules for how to handle an emergency:

- 1) Stay calm. Students may panic and become uncontrollable if the sense fear or anxiety;
- 2) Stop as soon as possible in a safe place, usually off the traveled roadway, preferable in a parking lot or driveway;
- 3) Secure the vehicle by putting the transmission in PARK, set the emergency brake and turn off the ignition;
- 4) Take the keys;
- 5) Contact dispatch;
- 6) Contact 911 for a serious medical emergency;
- 7) If necessary, use warning devices to alter other motorists you are stopped; and
- 8) If you must evacuate:
 - a) Explain what you are doing using simple, concise directions;
 - b) Use all exits if possible; and
 - c) Once students are off the school bus, move them to a safe place away from the school bus.

Lift Techniques for Evacuating Students

There are several techniques you need to know to get students with special needs out of the school bus in an emergency [National Highway Traffic Safety Administration, Emergency Situations:](#)

- 1) The one-person lift;
- 2) The two-person lift; and
- 3) The blanket drag.

General lifting guidelines include:

- 1) Never lift anymore more than half your weight;

- 2) Test your lifting ability with a small movement that can be stopped; and
- 3) If the student weighs too much, use another method.

General guidelines for lifting students:

- 1) Clear the path to the exit;
- 2) Tell the student exactly what you are going to do before you do it;
- 3) If necessary, cut the seat belt and other positioning straps;
- 4) Stand balanced with your feet shoulder width apart and face the student or face in the direction you want to go, if possible;
- 5) Get a good grip on the student of the student's clothing, use your palms, not just your fingers;
- 6) Squat down but keep your heels off the floor;
- 7) Get as close to the student as you can;
- 8) Lift gradually (without jerking) using your leg, abdominal, and buttock muscles;
- 9) Keep the student as close to you as possible;
- 10) Keep your chin tucked in so as to keep a relatively straight back and neckline;
- 11) Once you are standing, check directions by pointing your feet in the direction you want to go and turning your whole body;
- 12) Avoid twisting at your waist while carrying a student;
- 13) Take small steps, keeping the student close to your body.
- 14) For students with poor muscle control, curl the student as much as possible to keep the student's arms and legs from flopping and support the student's head and neck.

One-Person Lift:

- 1) Follow general lift guidelines;
- 2) Pass the student's near arm over your shoulder;
- 3) Place one of your arms behind the student's shoulders with your hand under the student's other arm;
- 4) Place your other arm under the student's knees;
- 5) Squat down with feet shoulder width apart; and
- 6) Lift the student with the load equally divided between both arms, holding the student close to you.

Two-Person Lift:

- 1) Move the student in a wheelchair as close to the exit as possible;
- 2) Slide the student on a seat next to the aisle;

- 3) The taller person stands behind the student and the other person stands in front of the student and off to the side;
- 4) If the student is in a wheelchair; the person in front should remove the armrests and fold up the footrests;
- 5) The person in the back reaches under the student's arms and either:
 - a) Grasps right hand to student's right wrist and left hand to student's left wrist; or
 - b) Clasps hands across the student's chest.
- 6) The person in front lifts the lower extremities under the thighs and hips; and
- 7) Squats down and lift together on a count of three.

General procedures for a blanket drag:

- 1) Using a blanket reduces stress on the student's body and the chance of injury;
- 2) The blanket drag is also a way to move heavier students or fragile students who might be hurt by lifting;
- 3) The blanket drag is not a good choice for students who are medically fragile;
- 4) Follow general lifting guidelines;
- 5) Fold a blanket in half and place it on the floor next to the student;
- 6) Lower the student's legs onto the blanket first, then the head. Make sure to place the student's head toward the exit;
- 7) Wrap the blanket around the student to prevent arms and legs from being caught on obstacles; and
- 8) Grasp the blanket near the student's head and drag the student to the exit.

Emergency Evacuation Procedures for Infants, Toddlers and Preschool Age Children

Because infants, toddlers and pre-school age children must be transported in Child Safety Restraint Systems (CSRS's), a plan will need to be established with regard to emergency evacuations.

Emergency evacuation procedures require that the children be individually loaded and unloaded.

In the event of an emergency, there will need to be:

- 1) A written plan on emergency evacuation procedures for infants, toddlers and pre-school age children who are secured in Child Safety Restraint Systems (CSRSs).
- 2) Emergency evacuation drills are practiced on a scheduled basis, at least as often as required for other school age children.
- 3) Personnel involved in transporting children in CSRSs should be trained in evacuation and emergency procedures.
- 4) All school buses carrying children in CSRSs carry safety belt cutters that are accessible only to the driver and any assistants.

5) CSRSs should not be placed in school bus seat adjacent to emergency exit.

Unit D1.6 Railroad-Highway Grade Crossings

This unit must teach driver-trainees the dangers trains present and the importance of the school bus driver and students strictly following railroad crossing procedures. Instruction must be given on the types of crossings, warning signs and devices, and State and local procedures and regulations for school buses when crossing railroad-highway grade crossings.

Procedures For Crossing Railroad Tracks

Recap [Section 1.3.3 Railroad-Highway Grade Crossings](#) for types of crossings, warning signs and devices.

Approaching the Crossing ([Nevada Commercial Driver License Manual](#), pg. 10-8).

- 1) Scan your surroundings and check for traffic in all directions using a five-count mirror check.
- 2) Activate your turn signal 100 feet in residential and 300 feet on a highway and get into the right lane far in advance of the stop. You must be on the traveled part of the roadway, not the shoulder.
- 3) Slow down and test your brakes.
- 4) Activate your four-way hazard lights approximately 200 feet before the crossing. Make sure your intentions are known.
- 5) Scan your surroundings and check for traffic in all directions using a five-count mirror check.
- 6) Stay to the right of the road without leaving the paved road.
- 7) Choose an escape route in the event of a brake failure or problems behind you.
- 8) Scan your surroundings and check for traffic in all directions using a five-count mirror check.



At the Crossing

- 1) Bring the bus to a full and complete stop no less than 15 feet and no more than 50 feet from the nearest rail, where you have the best view of the tracks;

- 2) Place the transmission in Park, or if there is no Park shift point, in Neutral and press down on service brake or set the parking brake.
- 3) Turn off all radios and noisy equipment and silence your students.
- 4) Open the service door and driver's window. Look and listen in both directions for an approaching train; and
- 5) Check beyond the track or tracks for traffic congestion, a signal or STOP sign. [Nevada Revised Statute 484B.560](#) It is illegal for any vehicle to fail to completely cross the track or tracks without stopping due to insufficient:
 - a) Space for the vehicle on the opposite side of the railroad crossing; or
 - b) Undercarriage clearance of the vehicle. Completely cross means to travel across a railroad track or tracks in such a manner that the trailing end of the bus is 15 feet or more past the nearest railroad track.



Crossing the Track

[Nevada Commercial Driver License Manual](#), (pg. 10-9)

- 1) Check the crossing signals again before proceeding;
- 2) At a multiple-track crossing, stop **ONLY** before the first set of tracks. When you are sure no train is approaching on any track, proceed across all of the tracks until you have completely cleared them.
- 3) Release the transmission or parking brake.
- 4) Close the door. Continue to **look** and **listen** for an approaching train.
- 5) Cross the tracks in a low gear as quickly as possible. Do not change gears.
- 6) Never permit traffic conditions to trap you in a position where you have to stop on the tracks. Be sure you can get all the way across the tracks before you start across.
- 7) Turn off your hazard lights, deactivate the noise shutoff switch, and activate the master switch.
- 8) If the gate comes down after you have started across, drive through it even if it means you will break the gate.

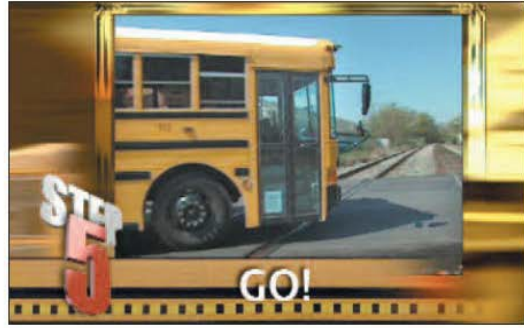

Unit D1.7 Student Management

This unit must teach driver-trainees how to manage student behavior on the bus to ensure that safety is maintained, and the rights of others are respected. Specific student management techniques must be discussed, including warning signs of bullying and the techniques for managing student behavior and administering discipline. Training providers must teach driver-trainees to avoid becoming distracted by student behavior while driving, especially when crossing railroad tracks and during loading and unloading.

Student Management

Student management on school buses and at the school bus stop is one of the biggest problems confronting school bus drivers. In order to get students to and from school safely and on time, you need to be able to manage your students so you can concentrate on driving.

Students riding your bus must understand from the beginning that you cannot allow anyone's actions to keep you from providing for the safety of your passengers and yourself. The relationships you will experience daily are with individuals whose behavior ranges somewhere between that of an infant and a young adult. Without a clear understanding of who is in charge, the conditions could become unmanageable and potentially dangerous for everyone. The climate that exists on the school bus is up to you!



Steps for Appropriate Student Management

[School Bus Fleet Maintaining Order on Unruly Route](#)

- 1) Understand students and what it is like to be an adolescent: the excitement, the fears, the uncertainty, the need to belong, and the need to get attention. Anticipate possible problem times when students will be more excited, distracted or “rowdy,” such as the last day before a vacation, a special holiday, or an event.
- 2) Anticipate emergencies. Plan ahead for emergency situations and determine how you will manage student behavior during them. Which students will need more reassurance or structure or direction during an emergency? Which students can you count on for assistance?
- 3) Monitoring behavior on a bus is using common sense. If two children are not getting along, separate them.
- 4) Confronting students in front of their peers is never a good idea. This is a form of punishment and will tend to have negative results. Always allow students to save face by

approaching them on a one-on-one basis. Talk with them when the other students are not around. Remain calm, dignified, and offer them choices.

- 5) Any time a student is violating an important safety rule, give the student a direct command.
- 6) Give students specific directions when you need to do so and let them know the consequences if they choose not to follow the direction.
- 7) Avoid personality conflicts. Some students' personalities or communication styles may conflict or differ from your own, and those differences may annoy you. Remember to separate the student from the behavior and treat these students as you treat all others.
- 8) Treat all students in a casual, friendly way without over-acting or over-reacting in either a positive or a negative manner. Maintain a professional distance between yourself and students.
- 9) Use a calm tone of voice.
- 10) If a student wants to argue when you are asking them to behave differently, simply restate your request calmly. If the student asks you why, explain your safety reason, but do so only once. You will never win an argument with a student.
- 11) Keep your hands to yourself.

Maintain your sense of humor!

When there is a problem

[Nevada Commercial Driver License Manual](#), (pg. 10-9)

- 1) Always follow your school's procedure for requesting assistance.
- 2) Call 911 for serious, immediate assistance and then contact dispatch.
- 3) If necessary and approved by dispatch, stop, and secure the bus and take the ignition key with you if you leave the seat.
- 4) Stand up and speak in a firm voice without showing emotion. Address the offender and explain the expected behavior on the school bus.
- 5) Never put a student off the bus except at school or at his or her designated school bus stop. If you feel that the offense is serious enough that you cannot safely drive the bus, call for a school administrator or the police to come and remove the student.
- 6) Follow your school's procedure for requesting assistance.
- 7) Never put yourself or your student in harm's way.

Always call 911 for serious problems that are an immediate threat to the safety of your students and you.



Student Responsibilities

Proper student behavior is important because the distraction of the driver can contribute to crashes. Students and parents should be made aware of and abide by school bus regulations for enhanced safety ([National School Bus Specification and Procedures, 2015](#), pg. 138). Students and parents should:

- 1) Receive a copy of the rules and procedure
- 2) Be aware that they are responsible for their actions and behavior;
- 3) Display respect for the rights and comfort of others;
- 4) Be taught to realize that school bus transportation is a privilege not a right that can be denied to students who break the rules;
- 5) Be aware that any time the bus driver is distracted it is potentially hazardous to the safety of all passengers, the bus driver, other pedestrians, and motorists;
- 6) Be aware of the dangers involved walking to and from, in and around the loading and unloading zone and appropriate safety measures to take when in the Danger Zone.

Student Bus Rules

Please check with your school transportation director for your district or school's Student Code of Conduct. The following are some helpful guidelines.

- 1) Keep rules short and less is more.
- 2) Frame rules as expectations for example, please keep your bus clean.
- 3) Focus on safety.



Music on The Bus

Music is a district preference; it just cannot be a safety hazard. Be sure to check with your school or district policy.

Students are not allowed to play their music without headphones while on the bus.



Video Monitoring Systems

School districts now use video monitoring systems in order to protect students and drivers. It does not replace the discipline policy, the authority of the driver, or the responsibility of school officials. It is simply a tool to aid the driver and district administrators.

If there is a video monitoring system on your school bus, students and drivers will be notified if they are subject to being videotaped.

Evidence obtained from video monitoring systems can be used for disciplinary action against a driver or student.

Transporting Special Populations

McKinney-Vento Homeless Assistance Act

The McKinney-Vento program is designed to address the problems that children and youth experiencing homelessness have faced in enrolling, attending, and succeeding in school. Under this program, Local Education Agencies (LEAs) must ensure that each homeless child and youth has equal access to the same free, appropriate public education, including preschool education, as all children and youth ([United States Department of Education's Homeless Children and Youth Program](#)).

If an LEA does not receive McKinney-Vento funds, Title I Part A funds can be used for youth experiencing homelessness to address associated transportation and access barriers.

Lack of transportation is the number one barrier that homeless children and youth faced in attending school regularly.

[United States Department of Education, Homeless Student Guide](#)
(pg. 27-31)

Definition of Homeless Children and Youth

[National Center for Homeless Education \(NCHE\), Transporting Children and Youth Experiencing Homelessness](#)

Students experiencing homelessness are defined as:

- 1) Individuals who lack a fixed, regular, and adequate nighttime residence.
- 2) Children and youth who are sharing the house of other persons due to loss of housing, economic hardship, or a similar reason;
- 3) Children who are living in motels, hotels, trailer parks, or camping grounds due to the lack of alternative adequate accommodations; are living in emergency or transitional shelters; or are abandoned in hospitals.
- 4) Children and youth who have a primary nighttime residence that is a public or private place not designed for or ordinarily used as a regular sleeping accommodation for human beings.
- 5) Children and youth who are living in cars, parks, public spaces, abandoned buildings, substandard house, bus or train stations, or similar settings.
- 6) Migratory children who qualify as homeless because the children are living in circumstances described above ([National Center for Homeless Education \(NCHE\), Transporting Children and Youth Experiencing Homelessness](#)).

Summary of Key Provisions of McKinney-Vento

Students who have been identified as experiencing homelessness by their school district liaison must be provided transportation to and from their school of origin ([National Center for Homeless Education, Transporting Children and Youth Experiencing Homelessness](#)).

- 1) Local Educational Agencies (LEAs) must provide students experiencing homelessness with transportation to and from the school of origin at the request of a parent or guardian, or in the case of an unaccompanied youth.
- 2) In addition to providing transportation to the school of origin, LEAs must provide students with transportation services comparable to those provided to other students in the school.
- 3) Students experiencing homelessness must be provided services comparable to those offered to other students in the school, including transportation.



School Bus Drivers and Students Experiencing Homelessness

School bus drivers must be very sensitive to students experiencing homelessness. A student's living situation must be kept confidential and school bus drivers need to be kind and assist these students through this difficult time in their lives with as little disruption as possible.

Developing close ties among school homeless liaisons, school staff and your supervisor is critical.

Drivers need to be sensitive to homeless children and keep their living conditions confidential!

Transporting Students With Special Needs

Federal law mandates that students with disabilities must be allowed to participate with nondisabled students in both academic and non-academic services, including transportation. Transporting students with disabilities and special health care needs requires specially designed transportation as a "related service."

Laws Affecting Transportation for Students with Special Needs

The [Rehabilitation Act of 1973](#) protects the rights of students with disabilities in programs and activities and requires that no disabled individual be excluded from participating in, or be denied the benefits of any program receiving federal financial assistance.

Students with a disability must be provided a [Free and Appropriate Education \(FAPE\)](#) and must be educated with their nondisabled students. A student with disabilities must be placed in the regular education environment, unless it can be demonstrated that the student's needs cannot be met satisfactorily with the use of supplementary aids and services.

The [Individuals with Disabilities Education Act \(IDEA\)](#) is the law that makes available a free and appropriate public education to eligible children with disabilities and ensures related services to children and youth ages 3 through 21. The purpose of IDEA is:

- 1) To ensure that all children with disabilities have to them a free and appropriate public education that emphasizes special education and related services designed to meet their unique needs and prepare them for further education, employment, and independent

living;

- 2) To ensure that the rights of children with disabilities and parents of such children are protected; and
- 3) To ensure that educators and parents have the necessary tools to improved educational results for children with disabilities by supported system improvement activities; coordinated technical assistance and support.

The [Family Educational Rights and Privacy Act \(FERPA\)](#) protects the privacy of student education records. FERPA gives parents certain rights with respect to their children's education records. Generally, schools must have written permission from the parent or eligible student in order to release any information from student's educational record. However, FERPA does allow schools to disclose those records, without consent, to the following parties:

- 1) School officials with legitimate educational interest;
- 2) Other schools to which a student is transferring;
- 3) Specified official for audit or evaluation purposes;
- 4) Appropriate parties in connection with financial aid to a student;
- 5) Organizations conducting certain studies for or on behalf of the school;
- 6) Accrediting organizations;
- 7) To comply with a judicial order or lawfully issued subpoena; and
- 8) Appropriate officials in cases of health and safety emergencies.
- 9) State and local authorities, within a juvenile justice system, pursuant to specific State law

The [Health Insurance Portability and Accountability Act \(HIPAA\)](#) assures that individual health information is protected while allowing the flow of important health information needed to provide and promote high quality health care. It protects personally identifiable information (PII) held or transmitted to the school.



Terms and Definitions

Assistive technology device. A piece of equipment, or product system modified or customized, that is used to increase, maintain, or improve functional capabilities of a child with a disability.

Assistive technology service. Any service that directly assists a child with a disability.

Child with a disability. A child who has been evaluated as having an impairment for which the child needs special education and related services ([U.S. Department of Education Section 800.3, Definitions](#)).

Special education. Specially designed instruction, at no cost to the parents, to meet the unique needs of a child with a disability.

Family Education Rights and Privacy Act (FERPA). Protects student privacy and requires parent/guardian permission for others to access a student's educational record except for school officials who have a legitimate educational interest.

Free Appropriate Public Education (FAPE). Requires that students with disabilities are entitled to a free education that is appropriate to their age and abilities.

Individualized Education Program (IEP). A written statement for a student with a disability designed to meet his/her unique educational needs ([United States Department of Education, Guide to IEP's](#)).

Local Education Agency (LEA). The local education agency is the school district; each IEP team should have an LEA representative who can determine the district's available resources and vouch for the district's implementation of the IEP.

Individual Family Support Plans (IFSPs). A plan written for a child, birth to three years. Family involvement is required.

Least Restrictive Environment (LRE). Students with disabilities must be educated with their non-disabled peers to the maximum extent possible. This includes transportation services.

US Office of Civil Rights. The Office of Civil Rights is in place to protect the rights of students with disabilities and to ensure that school districts are complying with the law.

Individualized Education Program (IEP)

The IEP team is a formal group that designs a student's educational program, establishes measurable academic and functional goals, and determines the related services necessary for a student to access special education.

When transportation is considered, appropriate transportation staff, as related services providers, needs to be included in the IEP process to address the safety and feasibility of various transportation options.

The IEP team must consider several issues in order to assure the student is transported in the safest and least restrictive environment:

- 1) Can the student be safely transported on the school bus with other students;
- 2) If not, can the student be transported safely on the regular education bus if supplementary staff, equipment, and/or services are provided;
- 3) If not, what type of specialized transportation and/or equipment is required;

- 4) Is an aide, nurse or other qualified school personnel required;
- 5) Does the student require a responsible adult available for pick-up and drop off;
- 6) Is there a limit to the length of time the student can be on the bus;
- 7) Is the type of transportation requested viable;
- 8) Additional transportation restrictions that could impact the safe transportation of the student such as:
 - a) Behavior plan;
 - b) English proficiency;
 - c) Vision skills;
 - d) Communication needs; and
 - e) Assistive technology needs.

Transportation as a Related Service

If a child needs a particular related service, including transportation, then the related service professional needs to be involved in the development of the IEP ([United State Department of Education's IEP Guide](#)).

- 1) Audiology services;
- 2) Counseling services;
- 3) Early identification and assessment of disabilities in children;
- 4) Medical services;
- 5) Occupational therapy;
- 6) Orientation and mobility services;
- 7) Parent counseling and training;
- 8) Physical therapy;
- 9) Psychological services;
- 10) Recreation;
- 11) Rehabilitation counseling services;
- 12) School health services;
- 13) Social work services;
- 14) Speech-language pathology services; and
- 15) Transportation

Categories of Disabilities Defined - Age 3 Through 21

IDEA lists the following 13 different disability categories for children aged 3 through 21 that adversely affect a child's educational performance ([United States Department of Education](#),

[Section 800.3 Definitions\).](#)

- **Autism** is a developmental disability that significantly affects verbal and nonverbal communication and social interaction, generally evident before age three. Other characteristics are repetitive activities and movements, resistance to change in daily routines and unusual responses to sensory experiences.
- **Deaf-blindness** means simultaneous hearing and visual impairments, the combination of which causes such severe communication and other developmental and educational needs that they cannot be accommodated in special education programs solely for children with deafness or children with blindness.
- **Deafness** means a hearing impairment that is so severe that a child is impaired in processing linguistic information through hearing, with or without amplification.
- **Emotional disturbance** is a condition exhibiting one or more of the following characteristics over a long period of time and to a marked degree that adversely affects a child's education performance:
 - a. Inability to learn that cannot be explained by intellectual, sensory, or health factors;
 - b. Inability to build or maintain satisfactory interpersonal relationships with peers and teachers;
 - c. Inappropriate types of behavior or feelings under normal circumstances;
 - d. A general pervasive mood of unhappiness or depression;
 - e. A tendency to develop physical symptoms or fears associated with personal or school problems;
 - f. Includes schizophrenia; and
 - g. Does not include children who are socially maladjusted, unless it is determined that they have an emotional disturbance.
- **Hearing impairment.** An impairment in hearing, whether permanent or fluctuating but is not included in the definition of deafness.
- **Intellectual disability** (formerly mental retardation). Significantly sub-average general intellectual functioning, existing concurrently with deficits in adaptive behavior and manifested during the developmental period.
- **Multiple disabilities** means simultaneous impairments (such as intellectual disability-blindness, intellectual disability-orthopedic impairment), the combination of which causes such severe educational needs that they cannot be accommodated in special education programs solely for one of the impairments. The term does not include deaf-blindness.
- **Orthopedic impairment** means a severe orthopedic impairment that includes impairments caused by congenital anomaly, impairments caused by disease (e.g., poliomyelitis or tuberculosis), and impairments from other causes (e.g., cerebral palsy, amputation, fractures, or burns)

- **Other health impairment** means having limited strength, vitality, or alertness, including a heightened alertness to environmental stimuli, that results in limited alertness with respect to the education environment that is due to chronic or acute health problems such as asthma, attention deficit disorder or attention deficit hyperactivity, diabetes, epilepsy, a heart condition, hemophilia, lead poisoning, leukemia, nephritis, rheumatic fever, sickle cell anemia, and Tourette syndrome.
- **Specific learning disability** means a disorder in one or more of the basic psychological processes involved in understanding or in using language, spoken or written, that may manifest itself in the imperfect ability to listen, think, speak, read, write, spell, or do mathematical calculations including conditions such as perceptual disabilities, brain injury, minimal brain dysfunction, dyslexia, and development aphasia.

The term does not include perceptual disabilities, brain injury, minimal brain dysfunction, dyslexia, and development aphasia. It does not include learning problems that are primarily the result of visual, hearing, or motor disabilities, of intellectual disability, of emotional disturbance, or of environmental, cultural, or economic disadvantage.

- **Speech or language impairment** means a communication disorder such as stuttering, impaired articulation, a language impairment, or a voice impairment.
- **Traumatic brain injury** means an acquired injury to the brain caused by an external force, resulting in total or partial functional disability or psychosocial impairment or both. The term applies to open or closed head injuries resulting in impairments in one or more areas, such as cognition; language; memory; attention; reasoning; abstract thinking; judgment; problem solving; sensory, perceptual, and motor abilities; psychosocial behavior; physical functions; information process and speech.

It does not include brain injuries that are congenital or degenerative, or to brain injuries induced by birth trauma.

- **Visual impairment including blindness** means an impairment of vision that, even with correction. The term includes both partial sight and blindness.

Student Behavior

In addition to physical limitations and their communication difficulties, some students have unusual or unpredictable behaviors that may startle you if you aren't prepared for them.

What we are talking about are behaviors that the student is unable to control. Some examples include:

- Rocking;
- Unpleasant language or repetitive phrases;
- Yelling or calling out or significant swallowing difficulty;
- Drooling;
- Difficulty sitting upright;
- Abnormal breathing patterns;

- Startle response to loud noises or fast movement, etc., e.g., to lift operation;
- Asthma; and
- Seizures.

[National Highway Traffic Safety Administration's, Transporting Students with Special Needs, \(Section II, Types of Disabilities and Behaviors\)](#)

Unique Characteristics

Knowing the unique characteristics of the students you transport will help you to react correctly. Like individuals, disabilities vary greatly. Remember that students are people first and then they are people with disabilities ([National Highway Traffic Safety Administration's, Transporting Students with Special Needs, Section II, Types of Disabilities and Behaviors](#)).

- 1) Your communication with any student with special needs depends on that student's abilities:
 - a) Don't let the focus be the student's condition; and
 - b) Treat each student as an individual.
- 2) Remember that you treat the student with special needs the same way that you treat any other student of that age.
 - a) Be respectful, don't talk down to the student;
 - b) Be positive and encouraging;
 - c) Allow as much independence as you can safely afford;
 - d) Learn the language of the students on your school bus, both verbal and non-verbal; and
 - e) Don't talk about the student as if he or she isn't there.
- 3) Remember that you are part of a team that cares about the student. Learn about the student's abilities by:
 - a) Talking with parents, caregivers, teachers, and therapists; and
 - b) Observing the student yourself.

Communication

Communicating with the Team

Determining and providing safe transportation for students with disabilities takes a team. Specialized transportation services must be included in the Individual Education Program (IEP) and the Transportation Department must be included in order to assure that the transportation services provided is safe, in the Least Restrictive Environment and in the best interests of the student.

By law, certain individuals must be involved in writing a child's IEP. If specialized transportation is required, then transportation personnel must also be included in the IEP team.

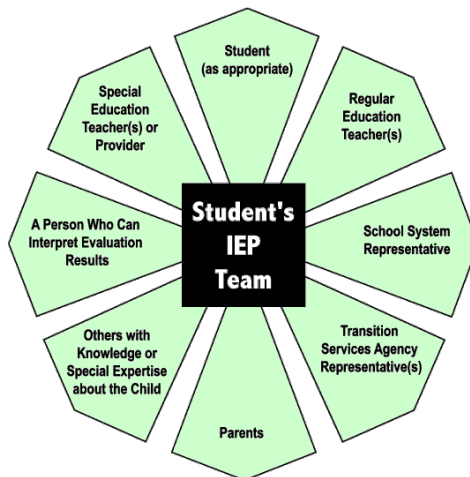

Communicating with Your Transportation Supervisor

Bus drivers are important to providing safe transportation as a related service and must be able to communicate and ask questions to your supervisor ([National Highway Traffic Safety Administration, Transporting Students with Special Needs](#), Section III, Team Communication Issues). Here are some examples of issues that could arise:

- 1) Service animals;
- 2) Wheelchair tires are flat or the battery is run down;
- 3) No wheelchair when student needs one;
- 4) Student has a stroller instead of a wheelchair;
- 5) Wheelchair or safety seat inappropriate for the size of the child;
- 6) Can't get the child safety restraint secured properly;
- 7) Securement equipment dirty;
- 8) A really large oxygen tank;
- 9) A wagon carrying the oxygen tank;
- 10) Equipment you might not be familiar with;
- 11) Being asked to give students medication against policy;
- 12) Being asked to do an unauthorized drop-off; or
- 13) How should I handle difficult, unusual, or inappropriate requests, from parents, teachers or other staff that have not been approved by your supervisor or the IEP Team.

Communicating with Parents and Caregivers

Remember that you are not alone in dealing with parents and caregivers. You are not obligated to do everything a parent or caregiver requests although some requests may make it easier to transport the student. Know which questions to refer to your supervisor, it's not your job to be a go-between

with parents and teachers.

Be sensitive in dealing with parents and caregivers:

- 1) Be firm but kind;
- 2) Explain why something is done a certain way and refer them to your supervisor if needed;
- 3) Remember that parents and caregivers are advocating for the student's needs. However, they aren't in a position to tell you what your job is and how to do it; and
- 4) Know your districts policy and procedures for communicating with parents and caregivers.

Communicating with Special Needs Students

It's important to remember that even if a student can't verbally communicate with you, they often understand what you say to them.

- 1) Know and respect the cognitive capacity of the student.
- 2) At the level the student can understand, explain what you are going to do and why before you do it. Explain again while you are doing it (if appropriate).
- 3) It's helpful to explain things in terms of safety reasons. For example, "you need to stay seated because it is not safe for you to be out of your seat."
- 4) Keep bus rules simple and repeat them often to help students understand. Bus rules should be simple:
 - a) Remain seated;
 - b) Don't touch any bus parts;
 - c) Don't touch other students;
 - d) Keep your seat belt on; or
 - e) Be cooperative.
- 5) Reinforce bus rules by praising students who follow them.

Communicating in Emergencies

If you encounter a situation that you hadn't expected, your first response should be to contact dispatch and request advice from your supervisor ([National Highway Traffic Safety Administration, Team Communication Issues](#)).

If you have a medical emergency, don't delay in notifying dispatch, and call 911 if the medical emergency exceeds your training. When contacting dispatch, remember to respect confidentiality when using:

- 1) Radios and cell phones are not secure;
- 2) Use discretion when talking over non-secure lines;
- 3) Avoid using personal identifying information unless you have no other choice; and

- 4) Use a code system to identify the severity of the situation.

Depending on the situation you may need to pull the bus over at a safe place or decide to drive the school bus to the help site or meeting point with emergency personnel.

- **DO NOT** tell other drivers or non-drivers about the situation. Respect the confidentiality of your students; and
- Know your school district policies for communicating with emergency responders and your school district.

Wheelchair Lifts

Components of a Wheelchair Lift

- 1) Platforms;
- 2) Outboard roll stop;
- 3) Inboard roll stop;
- 4) Handrails;
- 5) Vertical arms;
- 6) Top and bottom parallel arms;
- 7) Base plate; and
- 8) Hydraulic pump with manual backup.



Wheelchair Lift Safety Features

There are several safety features on the wheelchair lift.

- 1) The outboard roll stop which is activated by the up and down buttons:
 - a) When the up button is pushed, the outboard roll stop rotates to the vertical position before the platform rises; or

- b) When the down button is pushed, the outboard roll stop does not rotate to the horizontal position until the platform is lowered fully to the ground.
- 2) The inboard roll stop position is also activated by the up and down buttons:
 - a) When the down button is pushed, the inboard roll stop rotates to a vertical position;
 - b) It remains in the vertical position while the wheelchair is loaded or unloaded on the ground; and
 - c) When the up button is pushed, the inboard roll stop rotates to the horizontal position when the platform reaches the vehicle floor level.
- 3) The bridge plate rotates to the horizontal position when the unfold button is pushed. It rotates to the vertical position when the fold button is pushed.
- 4) Interlock devices prevent operation of the lift or the school bus when it is not safe. Interlock devices can work in a variety of ways:
 - a) Locks the school bus transmission in place when the lift is deployed;
 - b) Doesn't allow the lift to be deployed until the school bus is in PARK and the emergency brake is set; and
 - c) Stalls the school bus engine if the lift is deployed and the emergency brake is released, or the transmission is shifted from PARK.
- 5) Discontinue operation immediately if any of these safety features do not work properly ([National Highway Traffic Safety Administration, In-Service Safety Series](#) (Section V Loading and Unloading)).

Wheelchair Lift Out-of-Service

A school bus equipped with a wheelchair lift can be placed out of service if any of the following are found.

- 1) The wheelchair lift does not function or is inoperable;
- 2) Any hydraulic line leaks during operation;
- 3) The wheelchair lift whose brake interlock system is non-operational;
- 4) The wheelchair lift platform barrier/roll stop is non-operational; or
- 5) The wheelchair restraint system is not secured to the bus ([Nevada School Bus Out-of-Service Criteria](#)).

Who Can Use a Wheelchair Lift?

Wheelchair lifts are designed to be used by:

- 1) Anyone using a wheelchair or other mobility aid;
- 2) Someone sitting in a folding chair;
- 3) A person who has difficulty using steps (for example someone using a walker, crutches,

braces, or a cane);

- 4) Due to liability, schools should never allow someone to stand on a lift;
- 5) A loaner wheelchair or a stroller must be used for lift use;
- 6) Lift attendants/bus aides cannot ride on the platform lift with the student.
- 7) If you experience a power or equipment failure and you have a child on the lift, you can operate the lift manually.

Loading and Securing the Wheelchair

Loading, securing, and unloading students with special needs requires more than one person. In all cases, the school bus driver is responsible for safely loading, securing, and unloading students safely.

School Bus Position

You must position your school bus in the correct position before using the wheelchair lift.

- 1) Before using the wheelchair lift, park the vehicle on level ground. Do not park on a slope.
- 2) Remember that the platform must rest completely on the ground. Choose a place without obstacles to interfere with the operation of the lift; and
- 3) Review the operation of the interlock device on your school bus.

Loading the Wheelchair

Remember to tell the student what you are going to do before you do it.

- 1) Open and secure the lift door.
- 2) Use the hand-held control to activate the unfolding of the platform
- 3) Lower the platform until it rests entirely on the ground.
- 4) Unfold the outboard roll stop.
- 5) Fasten the wheelchair seat belt around the student.
- 6) Back the student onto the lift. Always face the student away from the school bus.
- 7) Student's using a motorized wheelchair cannot drive onto the lift. Disengage the motor and push the chair onto the platform manually.
- 8) Lock the wheelchair brakes.
- 9) Turn off the wheelchair power. In some cases, the motor must be disengaged to secure the wheelchair.
- 10) Make sure the roll stops are in the completely up position.
- 11) Have the student hold onto the handrails if able.
- 12) Tell the student to keep arms and legs within the lift area and clear of moving parts.
- 13) Never ride the power lift with students on it.
- 14) Operate the lift controls by:
 - a) Standing next to the platform at the front corner; and
 - b) Keep one hand on the wheelchair as it is raised and operate the controls with the other hand.
- 15) When the platform reaches the floor level, set down or hang up the controls.
- 16) Release the wheelchair brakes and push the wheelchair into the bus.
- 17) Set the wheelchair brakes.
- 18) Fold the lift into the travel position.
- 19) Position the student according to the IEP. The IEP should specify whether to transfer the student to a forward-facing school bus seat or whether to secure the wheelchair and the student.
- 20) Never allow students to operate the lift ([National Highway Traffic Safety Administration, In-Service Safety Series](#), Section V Loading and Unloading).

Placement of Students

Where you seat the students on your school bus should not be haphazard.

You should think about and lay out a seating plan for your school bus. Some things you should consider when developing a **seating plan** include:

- 1) Your route and the order in which students are loaded and unloaded at home and at school;
- 2) The medical conditions of the student;
- 3) Evacuation;
- 4) Behavior;
- 5) Supervision;
- 6) The age of the student; and
- 7) Your ability to observe the student.

When considering **medical conditions**, think about:

- 1) Students who are medically fragile or vulnerable and who need to sit further front where there is less bounce;
- 2) Students who are prone to seizures in certain light conditions;
- 3) Younger students and those in child safety seats who need to sit in the first few seats;
- 4) Student with respiratory conditions who need to sit away from the lift area and away from rear windows near exhaust. Changes in temperature also tend to bother these students; and
- 5) Students who may need to sit over wheel wells for additional lower extremity support.

When considering **evacuation**, think about:

- 1) Which students can evacuate themselves;
- 2) Which students can help;
- 3) Which students can help others;
- 4) Which students are in child safety seats;
- 5) Who should not be in emergency exit rows or in an aisle seat with students who are unrestrained seated in the window seat.
- 6) Which students are compatible, and which are not;
- 7) Which students need supervision either for behavior or for a medical condition;
- 8) Put your plan in writing, which will be especially helpful for a substitute driver.

Federal Standards for Wheelchair Securement Systems

[Federal Motor Vehicle Safety Standard 571.222, School Bus Passenger Seating and Crash Protection](#) has specific requirements for wheelchair securement and wheelchair occupant restraint systems.

Remember that there is a difference between the seat belt (used for occupant restraint) and a postural aid or pelvic belt (used to hold in or to hold erect a student with a particular disability).

- 1) Do not jerry-rig a securement for a wheelchair.

- 2) Use only approved 4-point tie-down systems.
- 3) Do not interchange systems. Use only one manufacturer's tie-down system for each wheelchair.
- 4) Never place a wheelchair in front of an emergency exit door even if the wheelchair securement position is provided in that location.

Securing the Wheelchair

- 1) Center the wheelchair with the anchorages on the floor. Leave room for the rear belt to be secured at a 45-degree angle from the floor.



- 2) Set the wheelchair brakes on both sides and/or turn off the wheelchair power.
- 3) Attach the wheelchair straps to the wheelchair at 4 points:
 - a) Attach the straps along the wall first;
 - b) Then attach the straps along the aisle;
 - c) Attach the straps properly;
 - d) Do not attach the straps to the wheels or any detachable portion of the wheelchair;
 - e) Don't let the straps bend around any object. They should have a clear path from the floor to the wheelchair frame;
 - f) Keep the straps away from sharp edges or corners;

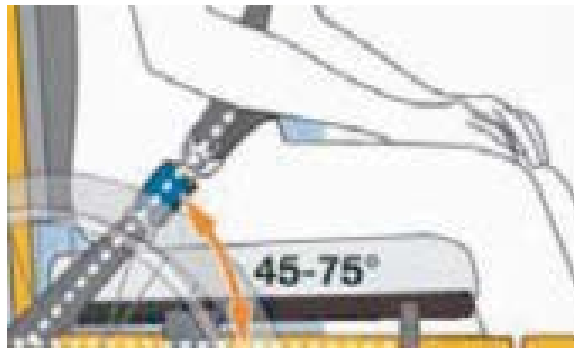

- g) Do not crisscross or twist the straps;
 - h) Make sure belts are at a 30 to 60-degree angle; a 45-degree angle is best;
 - i) Never use the 4-point system without also using the 3-point lap and shoulder belt.
 - j) Make sure that the wheelchair doesn't have forward or reverse movement; and
 - k) If you can't get the wheelchair secured properly, contact dispatch.
- 4) Attach the 3-point system to secure the student's pelvis and torso:
- a) Position the lap belt over the pelvic bone, not the abdomen;
 - b) Position the lap belt inside the arm rests between the side panels and the cushion;
 - c) Adjust the belt so it is snug;
 - d) Position the shoulder belts so it does not cross the student's face or neck;
 - e) Never position the shoulder belt under the student's arm where it would cross the rib cage;
 - f) Adjust the shoulder belt to achieve firm but comfortable tension; and
 - g) Never twist belts, the belts should always lie flat against the body.



To protect the rider during a crash or sudden braking, both a lap and shoulder belts must be used.

Never crisscross securement straps.



The front tie-down straps should anchor to the floor at points that are spaced wider than the wheelchair.

The rear anchor points for the rear tie-down straps are located directly behind the rear securement points on the wheelchair.

The diagonal shoulder belt should cross the middle of the shoulder and center of the chest and connect to the lap belt near the hip.

The Do and Do Nots of Securing a Wheelchair

- 1) **Do** attach the tie-down straps to welded junctions of the wheelchair frame or to other structural areas where the frame is fastened together with hardened steel bolts indicated by six raised lines or bumps on the bolt head.



- 2) **Do not** attach tie-downs to adjustable moving or removable parts of the wheelchair such as armrests, footrests, and heels!

- 3) **Do** choose structural securement points closest to the seat surface as possible to provide greater wheelchair stability during travel.
- 4) **Do** pick rear securement points that are high enough to result in angles of the rear tie-down straps between 30 and 45 degrees to the horizontal.
- 5) **Do not** mix wheelchair securement points between the seat and base.
- 6) Read and follow all manufacturers' instructions.
- 7) It is best to ride with the wheelchair backrest positioned at an angle of 30 degrees or less to the vertical. If a greater recline is needed, the shoulder belt anchor point should be moved rearward along the vehicle sidewall, so the belt maintains contact with the rider's shoulder and chest.
- 8) Maximize the clear space around the rider to reduce the possibility of contact with vehicle components and other passengers in a crash. Cover rigid vehicle components that are close to the rider with dense padding.
- 9) Check wheelchair and WTORS equipment regularly and replace worn components.
- 10) Keep WTORS anchorage track free of debris.
- 11) If possible, remove hard trays and secure them in the vehicle to reduce the chance of rider injury from contact with the tray.
- 12) A properly positioned headrest may help protect the neck in a rear impact.
- 13) If it is necessary use a head and neck support during travel, the soft collar should not be attached to the seating system.
- 14) Secure medical and other equipment to the wheelchair or vehicle to prevent it from breaking loose and cause injuries in a crash ([National School Transportation Specifications and Procedures](#), pg. 446).
- 15) **Do not** mix or interchange securement systems.

When properly secured, there is no allowable movement of a wheelchair!

Other Important Points

General Guidelines for Drivers of Students with Special Needs

Transporting students with disabilities is far more difficult than transporting their non-disabled peers. There are some general guidelines that will help you when transporting students with special needs.

1. Know about your students and what they need.
2. Know where important information is located:
 - a. The route;
 - b. Manufacturer's instructions for lifts and securement systems;

- c. The seating plan;
 - d. Emergency information;
 - e. DNR (Do Not Resuscitate) orders;
 - f. Special medical information; and
 - g. Emergency equipment (fire extinguishers, first aid kit, seat belt cutter, etc.).
3. Exercise universal precautions at all times.
 4. Do not use a wheelchair lift without another experienced driver or aide.
 5. Only do what is within your technical expertise. There are lots of other resources to assist you.
 6. Don't rush, take your time.
 7. When I doubt, ask.

Emergency Evacuation Drills

Nevada law requires that school bus evacuation drills be conducted at least two times per year, at the beginning of any field trip or activity, including helping passengers evacuate the school bus ([Nevada Revised Statute 386.820](#) and [National Transportation Safety Board Safety Recommendation, Oakland, Iowa](#)).

- All students, including students with special needs are required to participate in the drills.
- Make sure your instructions are simple and repeat them when necessary.

Bus Aides and Attendants

Bus aides and attendants provide assistance to students and the bus driver and must be trained on the special circumstances required to transport students with special needs. Bus aides and attendants will need to know:

1. How the IEP process works;
2. Your school district's policy for confidentiality of student information;
3. Legal issues, including federal and state laws, administrative rules and school district policies and procedures for special education students; and
4. Policies and procedures for:
 - a. Loading and unloading students with special needs;
 - b. Evacuation procedures, including the use of emergency equipment;
 - c. Lifting and positioning procedures for evacuating special needs students;
 - d. Behavior management, including procedures for dealing with inappropriate or unacceptable student behavior;
 - e. Knowledge in first aid and CPR, including universal standards for the spread of contagious and communicable diseases, blood borne pathogens and universal

- precaution procedures;
- f. Policies and procedures for detecting and reporting neglect or abuse; and
 - g. Policies and procedures for student's medicine and other articles that may have been left on the bus after an evacuation.

**The school bus driver is ultimately responsible for assuring
that all students are properly secured.**

Extended School Year (ESY)

Extended school year services are services for special education students that extend beyond the normal school year in accordance with a student's IEP.

Transporting Toddlers And Pre-School Children

In the State of Nevada, school districts are not required to provide transportation to students under the age of 3. With the new early childhood education programs in Nevada, schools are now transporting 3–5-year-olds in school buses.

Preschool children are the youngest, most vulnerable passengers on school buses. They depend on transportation personnel to provide a safe ride to and from early childhood education programs.

Transportation providers need to be knowledgeable and develop skills to adequately provide for the safety of young children while being transported on school buses. Infants, toddlers, and pre-school children with special physical, cognitive or behavioral needs present new challenges and responsibilities for transportation providers. These children require a great deal of supervision during the time they are in the school bus.

Some issues that must be addressed to assure safe transportation in the school bus include:

1. Physical handling;
2. Communication with young children;
3. Behavior management;
4. Child safety seats;
5. Restraint systems;
6. Safety vests;
7. Wheelchairs and occupant securement systems;
8. Special equipment management;
9. Medically fragile conditions;
10. Personnel training; and
11. Parental responsibilities.

Definitions

Individual programs may have variations in how these four terms are used. A **newborn** is a child

from birth to one month.

An **infant** is a child from one month to one year. A **toddler** is a child from one year to three years.

A **preschooler** is a child from three years to five years of age.

Transportation Services for Preschool Children with Disabilities

The Individualized Family Service Plan (IFSP) under Part C of IDEA addresses the unique needs of infants and toddlers with disabilities and their families. The IFSP process has two main parts:

- The IFSP meeting, where parents and interagency personnel jointly make decisions about an eligible child's early intervention services; and
- The IFSP document itself, which is a written plan for the provision of early intervention services for the child and family.

Driver and Aid Knowledge and Responsibility

As a school bus driver and a school bus aid, there is additional knowledgeable and responsibility when transporting pre-school age children. In addition to their regular duties, you will be responsible for:

1. General knowledge about the development of young children, including specific disability conditions.
2. Age-appropriate physical handling, communication, and behavior management of young children.
3. Appropriate use of all the equipment (e.g., power lifts, child restraint systems, safety vests, wheelchairs, securement devices/occupant restraints and safety belts).
4. Loading and unloading of children who are ambulatory or non-ambulatory.
5. Evacuation and evacuation drills.
6. Knowledge about transportation requirements on a child's IFSP or IEP, including confidentiality.
7. Knowledge about special needs on the vehicle.
8. Knowledge about child protection laws (e.g., abuse and neglect).
9. Effective communication skills with school staff, students, parents, law enforcement officials and the motoring public.

Child Safety Restraint Systems (CSRS)

Car seats used on school buses must be appropriate for the individual child and must be used correctly. All of the restraint systems used for transportation must be secured to the bus seat in the manner prescribed and approved by both the school bus manufacturer and CSRS directions.

Elements to Correctly Install CSRS

It is recognized that compartmentalization, the passive safety system required on school buses under FMVSS 222, provides a higher level of safety to children over 40 pounds without diagnosed

medical complexities or fragility than to children who might require special securement or positioning.

1. **Direction.** Position (rear or forward-facing) and adjust recline angle accordingly.
2. Use the correct belt path on the CSRS as directed by the manufacturer's instructions.
3. **Installation.** To achieve tight installation, place adult's full weight into the seat of the CSRS to compress the vehicle seat cushion. Pull the safety tight, buckle and lock the safety belt. The CSRS should not move more than 1-inch forward or side to side.

Convertible CSRS (Rear-Facing)

Rear-facing infant position is designed for babies from birth to twenty pounds, and one year of age (manufacturer's instructions) and usually less than 26 inches in length. The rear-facing position at a 45 degree recline supports the infant's head, neck and back.

1. The harness straps must be at or below the infant's shoulders.
2. Harness straps must be snug (allow one finger of space under the harness at the collar bone) and lie flat (not twisted).
3. The harness retainer clip, which is designed to hold the harness straps in place, is always at armpit level.
4. Avoid any extra padding or blankets behind the infant.
5. Avoid the use of a T-shield or tray shield with infants.

Note: There are several CSRSs that ride rear-facing to thirty pounds to accommodate the larger infant and to comply with NSTSA's Guideline for the Safe Transportation of Pre-School Age Children in School Buses."

Convertible CSRS (Forward-Facing)

1. Forward-facing CSRS with five-point harness, T-shield or tray shield are designed for children above twenty pounds to sixty pounds.
2. The seat should be adjusted to the upright position.
3. Harness straps must be in the upper slot (at or above the child's shoulders).
4. The seat may be used until the child's ears are above the back of the shell.
5. Harness straps must be snug (allow one finger of space under the harness at the collar bone) and lie flat (not twisted).

Note: There are some CSRS's that cannot be installed properly in a twenty-inch bus seat (i.e., tray-shield).

Car Beds

A car bed is for preschoolers and an infant up to 20 pounds allows the infant to lie flat. The use of a car bed must be approved by qualified personnel at an IFSP team meeting.

1. Lateral support can be added at both sides of the infant. Avoid placing padding around the infant's head to prevent airway blockage.

2. Beds must be secured to the bus seat, with the seat belt passing through both slide loops.
3. Adjust the harness system to a snug fit as specified by the manufacturer. Harness straps should lie flat (not twisted).
4. Caution should be given to gastronomy tubes, tracheotomies, and shunts.

Specialized Positioning Seats

These seats are used only when a child does not fit in a standard CSRS nor has a particular condition warranting more support.

1. The seat may require an additional tether strap to secure the seat to a bus seat.
2. The safety belt must be routed through the appropriate belt path specified by the manufacturer's instructions to secure the CSRS.
3. If a retainer clip is used, it must be positioned at armpit level.
4. Caution should be given to gastronomy tubes, tracheotomies, and shunts.

Booster Safety Seats (Belt Positioning Boosters Only)

A booster seat should be used only if children are between 40 and 80 pounds and must be used in conjunction with a lap- shoulder belt.

Safety Vests

Vest selection should be appropriate for the height, weight, and waist of the child. Proper fit must account for seasonal changes in clothing.

The decision to use a vest (with or without a wheelchair) should be made by an IFSP or IEP team that includes qualified personnel and the parent and noted on the IEP or IFSP.

1. Caution should be given to gastronomy-tubes, tracheotomies, and shunts.
2. Child may have a tendency to slide under the vest/safety belt or submarine and should be securely fitted with a crotch strap supplied by the manufacturer.
3. If unrestrained students share the seat with a student in a child safety restraint, the student using the restraint should be placed in a window-seating position.
4. The seat behind the child in a vest should be kept empty or occupied by a child who is also in a child safety restraint system.
5. Portable seat mounting straps should be checked for proper fit by transportation personnel during pre-trip inspection.
6. Get parent/guardian signature prior to the use of safety vests.

Unit D1.8 Special Safety Considerations

This unit must teach the driver-trainees the special safety considerations and equipment in school bus operations. Topics discussed must include use of strobe lights, driving in high winds, safe backing techniques, and preventing tail swing crashes.

Extra- Curricular Activity And Field Trips

Extra-curricular activity and field trips are an important part of school for many students. These trips require additional knowledge and skills to assure a safe and successful trip.



Maximum Speed Limits for School Buses on Extra-Curricular Activities

1. School buses **SHALL NOT** exceed 55 mph when transporting student to and from school.
2. School buses **CAN** drive the posted speed limit when transporting students to and from activities (extra-curricular, sports, field trips) that are part of the school program ([Nevada Revised Statute 484B.360](#)).
3. School districts have the authority to establish a maximum speed limit.

School buses can drive the posted speed limit when transporting students to and from activities (extra- curricular, sports, field trips).

White Flashing Strobe Light (Optional)

- Optional white flashing strobe lamp may be installed on the roof of a school bus. The strobe light may be mounted on the roof in the area directly over the restraining barrier on the driver's side.
- The strobe lamp may be wired to activate with the amber alternately flashing signal lamps, continuing through the full loading or unloading cycle and may be equipped with an override switch to allow activation of the strobe at any time for use in inclement weather.

Stopping the Bus

1. Push the brake pedal down gradually. The amount of brake pressure you need to stop the vehicle will depend on the speed of the vehicle and how quickly you need to stop. Control the pressure so the vehicle comes to a smooth and safe stop.

2. Since school buses are much heavier than other vehicles so it requires the driver to begin braking earlier in order to stop smoothly.
3. Brakes, tires, springs, and shock absorbers on heavy vehicles are designed to work best when the vehicle is fully loaded. Empty trucks require greater stopping distances because an empty vehicle has less traction
4. Get the big picture and begin slowing down far in advance of the stop.
5. Feather the brake by slightly reducing pressure on the brake pedal. This action will release a small amount of brake pressure right before the stop is complete, making a smoother stop.
6. Never stop suddenly unless absolutely necessary to avoid a collision. Students could be thrown around the bus.
7. Always maintain a safe following distance. The following distance should be long enough for you to be able to stop the bus safely and smoothly under any condition.
8. Short stopping/brake check is not acceptable for stopping the bus ([Nevada Commercial Driver License Manual](#), pg. 2-8).

Backing Safely

Backing a school bus is **STRONGLY DISCOURAGED**. Because you cannot see everything behind your bus, backing is always dangerous. Avoid backing and look for ways to go around instead of backing up. When you park, try to park so you will be able to pull forward when you leave.

You **CANNOT** back up a school bus when students are outside or around the bus. You can only back up the bus when all students are on board. Backing is dangerous!

Nevada Law states that the driver of a vehicle:

1. Shall not back the vehicle unless such movement can be made with reasonable safety and without interfering with other traffic;
2. Shall not back into an intersection, on or over a crosswalk, or around a street corner; and
3. Shall in every case yield the right-of-way to moving traffic and pedestrians ([Nevada Revised Statute 484B.113](#)).

If you must back up:

1. Start in the proper position. Put the bus in the best position to allow you to back safely and only once;
 - a. **Look at your path.** Look at your path before you begin and do not back the vehicle unless such a movement can be made safely without interfering with other traffic;
 - b. **Use mirrors on both sides.** Constantly check all mirrors, using the 5-count mirror check;
 - c. Back into, not out of a space;

- d. Always back as **SLOWLY as possible**;
- e. Back and turn toward the driver's side. Back to the driver's side so that you can see better. Backing toward the right side is very dangerous because you can't see as well. If you back and turn toward the driver's side, you can watch the rear of your vehicle by looking out the side window. Use driver-side backing, even if it means going around the block to put your vehicle in this position. The additional safety is worth it;
- f. Use a Helper or spotter. Use a helper when you can. The helper should stand near the back of your bus where the driver can see the helper. Before you begin backing, work out a hand signal you both understand which means STOP ([Nevada Commercial Driver License Manual](#), pg.2-8).
- g. If a helper/spotter is not available, **Get Out And Look (GOAL)**:
 - i. Set the parking brake;
 - ii. Turn off the motor and take the keys with you; and
 - iii. Walk to the rear of the bus to determine whether the way is clear.
- h. Do not back into an intersection (two Highways/roadways which join one another at a point), on or over a crosswalk, or around a street corner ([Nevada Revised Statute 484A.105](#));
- i. Make sure all students are on board before you back up the bus;
- j. **Honk your horn** so others know you are backing up the bus; and
- k. Yield the right-of-way to moving traffic and pedestrians ([Nevada Revised Statute 484B.113](#)).

Turning the Bus Around

If you must turn the bus around, you need to have at least 500 feet of unobstructed visibility in both directions and plenty of room to turn the bus around.

1. Select an area that is large enough to turn around without backing up the bus;
2. Slowly move the bus forward in a wide circle to turn around;
3. Turn around only at places designated by your district transportation department; and
4. Always keep the bus in the proper lane of travel.

Tail Swing

A school bus can have up to a three-foot tail swing. You need to check your mirrors before and during any turning movements to monitor the tail swing ([Nevada Commercial Driver Manual](#), pg. 10-11).

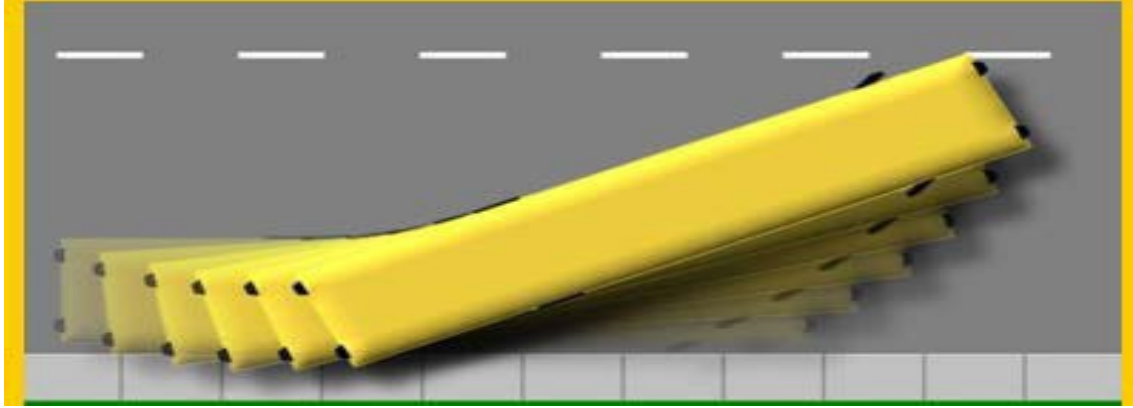

Driving in High Winds

Strong winds affect the handling of the school bus. The side of a school bus acts like a sail on a sailboat. Strong winds can push the school bus sideways. They can even move the school bus off the road or, in extreme conditions, tip it over.

Your school district will monitor and notify drivers if a road has been closed due to high winds or other conditions ([Nevada Department of Transportation Road Conditions](#)).

If you are caught in strong winds:

1. Keep a strong grip on the steering wheel. Try to anticipate gusts;
2. Slow down to lessen the effect of the wind, or pull off the roadway and wait; and
3. Contact your dispatcher to get more information on how to proceed ([Nevada Commercial Driver Manual](#), pg. 10-11).

Unit D1.9 Pre- and Post-Trip Inspections D1.9

This unit must teach the driver-trainees the importance of pre-trip, enroute, and post-trip inspections; and provide instruction in techniques for conducting such inspections of buses as stated in [§§ 392.7](#) and [396.11](#), and additionally demonstrate their ability to inspect the following:

1. Stop arms,
2. Crossing arms,
3. Emergency exits,
4. Fire extinguishers,
5. Passenger seats,
6. First aid kits,
7. Interior lights, and
8. Temperature control (for maintaining passenger comfort).

Training providers must instruct driver-trainees in State and local requirements, as applicable, for inspection of school bus equipment.

Why Inspect My School Bus

1. For the safety of your students.
2. Legally required by the [Federal Motor Carrier Safety Administration \(FMCSA\)](#), the [Nevada Department of Motor Vehicles \(DMV\)](#), and the Nevada State Board of Education and your school district.
3. For the safety of other drivers, passengers, and pedestrians around you, including to prevent crashes, breakdowns and reduce driver frustration.
4. Eliminate and reduce delays.
5. Prolong the life of the bus and reduce transportation costs. Recap and review [Unit 1.1.3 pre-trip and post-trip inspections](#).

Unit D1.10 School Bus Security

This unit must teach driver-trainees the security issues facing school bus drivers. Training providers must also teach driver-trainees potential security threats, techniques for preventing and responding to security threats, how to recognize and report suspicious behavior, and what to do in the event of a hijacking or attack on a school bus.

Security, Safety, Reporting, and Confidentiality Security

Each school day 17 percent (56.6 million) of the United States population is located in [our nation's schools](#). Approximately half of these children use a school bus for transportation to and from school each day. Additionally, millions of children ride school buses each day for school activity trips.

Identifying Security Threats

School bus security begins with you, your knowledge, and your best judgment. Being able to define and identify security threats and incidents will help you determine the appropriate course of action.

- A **security threat** is any source that may result in an event or occurrence that endangers life or property and may result in the loss of services or equipment.
- A **security incident** is an unforeseen event or occurrence that does not necessarily result in death, injury, or significant property damage, but may result in interruption of service ([Transportation Security Administration's Security Guide](#)).

The school bus driver and passengers are more likely to be targets of violence from students, parents, and unauthorized boarders.

Recommended Security Procedures

In addition to knowing your state and school's established procedures, the following guidelines can help ensure the safety and security of your student's and yourself.

1. Take the Transportation Security Administration's [First Observer Program](#) course.
2. Wear your required school uniform or identification badge.
3. Keep all vehicle doors, hatches, and compartments locked when the school bus is unattended.
4. Conduct pre-trip, security, and post-trip inspections.
5. Maintain an uncluttered bus.
6. Be constantly aware of people, activities, and items around you.
7. Immediately report any operational security weaknesses, suspicious persons or packages, and any damage to the school bus or school bus yard ([Transportation Security Administration, School Bus Security](#)).

Responding to a Security Incident

If you are threatened or involved in a security incident, remain calm and stay focused. When reporting, it is important that the information is accurate, detailed, and pertinent. Providing authorities with status of victims, indicators, and circumstances will assist with the effectiveness and timeliness when responding. When you have a security incident, you should:

1. Contact law enforcement/911 for immediate emergency assistance;
2. Notify dispatch or your supervisor immediately;
3. Report your exact location and any other pertinent information;
4. Identify type of threat and describe suspicious behavior, devise(s), packages, or odors;

Always call 911 for any serious, immediate threat!

5. Observe and notice weather conditions, especially wind direction for suspicious odors, mist, vapor, or powder;
6. Identify eyewitnesses;
7. For incidents that might involve a suspicious package, avoid using radios and cellular phones within 50 feet of package that may be explosives;
8. Remain calm and answer questions to the best of your recollection;
9. Clarify by repeating instructions just given;
10. Know your school's procedures to report and safely challenge any unidentified person in unauthorized or secured areas such as schools and bus yards;
11. Know the emergency procedures for your school; and
12. Know your school districts communication protocols and emergency codes for dispatch.

You cannot identify suspicious behavior based on stereotypes of race, color, or ethnicity.

Safety

Bullying

A safe and respectful learning environment is essential to emotional and academic achievement. Bullying is illegal in Nevada and is defined in [Nevada Revised Statute 388.122](#) as:

1. Repeated or pervasive taunting, name-calling, belittling, mocking or use of put-downs or demeaning humor regarding the actual or perceived race, color, national origin, ancestry, religion, gender identity or expression, sexual orientation, physical or mental disability of a person, sex or any other distinguishing characteristic or background of a person.
2. Behavior that is intended to harm another person by damaging or manipulating his or her relationships with others by conduct that includes, without limitation, spreading false

rumors.

3. Repeated or pervasive nonverbal threats or intimidation such as the use of aggressive, menacing, or disrespectful gestures.
4. Threats of harm to a person, to his or her possessions or to other persons, whether such threats are transmitted verbally, electronically or in writing.
5. Blackmail, extortion or demands for protection money or involuntary loans or donations.
6. Blocking access to any property or facility of a school.
7. Stalking.
8. Physically harmful contact with or injury to another person or his or her property.

This list is not exhaustive, and more information can be found [on the NDE website](#) or look for pamphlets published by NDE at any of your schools.

Immunity from Reporting

No action may be taken against any employee or student who reports bullying unless the person made the report with malice, intentional misconduct, gross negligence, or intentional or knowing violation of the law ([Nevada Revised Statute 388.137](#)).

Requirements for Reporting Bullying and Cyberbullying

1. Any employee who has cause to believe an act, event, situation, or conditions exists, is occurring or has occurred as soon as reasonably practicable.
2. Any employee, club or organization which uses the facilities of any school, regardless of any connection to the school or pupil, shall not engage in bullying or cyber-bullying on school property or at a school sponsored event or on any school bus.
3. Any employee who witnesses or receives information of any violation listed above shall report the violation to the principal or his/her designee as soon as reasonably practicable but not later than the same day.
4. Upon receiving a report, the principal shall immediately take any necessary action to stop the bullying and ensure the safety and well-being of the victim and begin an investigation into the report ([Nevada Revised Statute 388.1351](#)).

How to Report Violations

Schools are required to establish policies and procedures to report violations to a school police officer or local law enforcement agency or through SafeVoice. Please reference your school or district's policy for reporting bullying ([Nevada Revised Statute 388.1352](#)).

SafeVoice

[SafeVoice](#) is a confidential reporting system used to report threats to the safety or well-being of students. SafeVoice was established to protect student wellness, prevent violence, and save lives.

The SafeVoice program is in partnership with the Nevada Department of Public Safety and

provides a safe place to submit tips 24/7/365 concerning their own safety as well as the safety of others.

A Safe Learning Environment

A learning environment that is safe and respectful is essential for pupils to achieve academic success. Learning environments include the school bus [Nevada Revised Statute 388.132](#).

Employees of the school district must demonstrate appropriate and professional behavior and treat others with civility and respect. Employees should not tolerate bullying and cyber-bullying and take immediate action to protect a victim or target of bullying.

Threatening or Assaulting an Employee or Student

It is a misdemeanor for any person, against the student's will, to beat, whip, detain, or otherwise interfere with the student as the student is on their way to school ([Nevada Revised Statute 392.900](#)).

It is unlawful for any person to assault any student or school employee:

1. Within the building or grounds of the school.
2. On a bus, van or other motor vehicle owned, leased, or chartered by a school district to transport pupils or school employees.
3. At a location where the pupil or school employee is involved in an activity sponsored by a school ([Nevada Revised Statute 392.910](#)).

It is also illegal to threaten a pupil or school employee by oral, written, or electronic communication with the intent to:

1. Intimidate, harass, frighten, alarm, or distress a pupil or employee of a school;
2. Cause panic or civil unrest;
3. Interfere with the operation of a school; and
4. Through the use of cyber-bullying, threaten to cause bodily harm or death to a pupil or school employee with the intent to:
 - a. Intimidate, harass, frighten, alarm or distress;
 - b. Cause panic or civil unrest; and
 - c. Interfere with the operation of a school ([Nevada Revised Statute 392.915](#)).

Sexual Misconduct with Students

As a bus driver, you are an employee of a school and that makes it illegal to have inappropriate contact with any student.

Although the age of consent in Nevada is 16 years old, it is a Class C felony for an employee of a public or private school, to engage in sexual conduct with any student who is enrolled and attending school ([Nevada Revised Statute 201.540](#)).

The legal age of consent does not apply to a student!

Reporting Requirements

Mandatory Reporting

As a school employee, you are legally responsible to report all incidents of abuse or suspected abuse per [NRS 432B.220](#).

Reporting Child Abuse:

To report suspected child abuse or neglect in Nevada, you can call the Child Abuse Hotline at these numbers:

Clark County: (702) 399-0081

Washoe County: (775) 785-8600

All other Nevada counties: (800) 992-5757

Failure to Report

If you fail to report suspected abuse, you could be guilty of a misdemeanor for the first offense and a gross misdemeanor for the second offense ([Nevada Revised Statute 432B.240](#)).

Immunity from Civil or Criminal Liability

Any person who makes a report in good faith, of suspected abuse is immune from civil or criminal liability ([Nevada Revised Statute 432B.160](#)).

Requirements for Reporting Suspected Child Abuse

If you have reasonable cause to believe that a child has been abused or neglected, you shall:

- Report the abuse or neglect of the child to an agency which provides child welfare services or to a law enforcement agency; and
- Make such a report within 24 hours after you know or have reasonable cause to believe that the child has been abused or neglected ([Nevada Revised Statute 432B.220](#)).

In addition to the reporting requirements listed above in [Nevada Revised Statute 432B.220](#), school employees and volunteers who have a reasonable cause to believe that a child has been subject to the following by another employee or volunteer must report as soon as reasonably practicable, but not later than 24 hours suspected:

- Abuse, neglect, sexual conduct, or luring; or
- Corporal punishment by another employee or volunteer ([Nevada Revised Statute 392.303](#))

Confidentiality

There are several federal regulations that address student confidentiality that you should be aware of.

Family Educational Rights and Privacy Act (FERPA)

[Code of Federal Regulations 99.30, Family Education Rights & Privacy](#) protects the privacy of student education records. Schools must have written permission from the parent or eligible student in order to release any information from a student's education record.

However, FERPA allows schools to disclose those records, without consent, to the following parties under the following conditions:

1. School officials with legitimate educational interest;
2. Other schools to which a student is transferring;
3. Specified officials for audit or evaluation purposes;
4. Appropriate parties in connection with financial aid to a student;
5. Organizations conducting certain studies for or on behalf of the school;
6. Accrediting organizations;
7. To comply with a judicial order or lawfully issued subpoena;
8. Appropriate officials in cases of health and safety emergencies; and
9. State and local authorities, within a juvenile justice system, pursuant to specific State law ([United States Department of Education, FERPA Guidance](#)).

School transportation officials, including the bus driver, have a legitimate educational interest in knowing medical and safety issues of the students being transported.

Health Insurance Portability and Accountability Act (HIPAA)

The goal of HIPAA is to assure that individual's health information is properly protected while allowing the flow of health information needed to provide and promote high quality health care. It protects *personally identifiable information* (PII) held or transmitted to the school.

It is important to protect student health information and keep that information confidential ([United States Department of Health & Human Services, Summary of the HIPPA Privacy Rule](#)).

Hijacking and Attack on a Bus

Anticipating and prevention of threats is the best method. Never let anyone on your bus that shouldn't be there. If they force their way on and a situation does occur the driver's responsibilities is to the safety of the students. Plan and practice for situations to help remain cool. Use understandable codes with dispatch. Instead of saying they have been hijacked or a student has a gun use codes like Code Red. Driver's should check in periodically and if a check in is missed it could notify of a potential problem. The driver will need to make some important decisions very quickly. There are many factors that the driver will need to consider whether to comply or resist. In any decision the driver should remain calm and follow their districts policies and always make the student's protection is the number one priority.

Unit D1.11 Route and Stop Reviews

This unit must teach driver-trainees the importance of planning their routes prior to beginning driving in order to avoid distraction while on the road. The training provider must also teach driver-trainees the techniques for reviewing routes and stops, as well as State and local procedures for reporting hazards along the route and at bus stops.

Be prepared

Be familiar with written instructions of the assigned route that would include any exhibiting railroad crossing and any fixed route hazards. Practice driving your fixed routes and only drive routes that are established and approved by your employer. Do your pre-trip inspection so you can focus on driving. If doing an unfamiliar route look at maps and directions. Plan your stops so you can focus on the road.

Reporting hazards

If you notice any hazards on your route report them accordingly.

Section Behind the Wheel – Range and Public Road

This unit must consist of exercises related to basic vehicle control skills and mastery of basic maneuvers. Activities in this unit will take place on a driving range or a public road as defined in [§ 380.605](#). The instructor must engage in active communication with the driver-trainees during all active training sessions.

Unit D2.1 Danger Zones and Use of Mirrors

Driver-trainees must demonstrate the techniques necessary to ensure the safety of persons in the danger zone around the bus. Driver-trainees must practice mirror adjustment and usage. The types of mirrors and their use are shown, and cones used to demonstrate the requirements of [49 CFR 571.111](#).

Unit D2.2 Loading and Unloading

Driver-trainees must demonstrate the loading and unloading techniques learned in the theory portion of the training. Driver-trainees must demonstrate checking the vehicle for sleeping children and lost items at the end of the route.

Unit D2.3 Emergency Exit and Evacuation

Driver-trainees must demonstrate their role in safely evacuating the bus in an emergency.

Unit D2.3 Special Safety Considerations

Driver-trainees must demonstrate safe backing techniques and demonstrate their ability to avoid tail swing crashes by using reference points when making turns.

Unit D2.5 Pre- and Post-Trip Inspections

Driver-trainees must demonstrate proficiency in conducting pre-and post-trip inspections, as stated in [§§ 392.7](#) and [396.11](#), and of school bus-specific equipment, such as mirrors, stop arms, crossing arms, emergency exits, fire extinguishers, passenger seats, first aid kits, interior lights, and temperature control.

Unit D2.6 Railroad Highway Grade Crossings

Driver-trainees must demonstrate proper procedures for safely navigating railroad-highway grade crossings in a school bus.

ACRONYMS

1-2-3	1=Applied Test, 2=Emergency Warning Device, 3=Pump down to check for pop out.
ADHD	Attention Deficit Hyperactivity Disorder
BAC	Blood Alcohol Concentration
BP	Blood Pressure
CDL	Commercial Driver's License
CLP	Commercial Learners Permit
CDLIS	Commercial Driver's License Information System
CFR	Code of Federal Regulations
CMV	Commercial Motor Vehicle
CNG	Compressed Natural Gas
CSRS's	Child Safety Restraint Systems
DEF	Diesel Exhaust Fluid
DHS	Department of Homeland Security
DMV	Department of Motor Vehicles
DOC	Diesel Oxygenation Catalyst
DOT	Department of Transportation
DNR	Do Not Resuscitate
DRL	Daytime Running Lamps
ECP	Exposure Control Plan
EHA	Education of the Handicapped Act
ELDT	Entry Level Driver Training
ESY	Extended School Year
FAPE	Free and Appropriate Education
FERPA	Family Educational Rights and Privacy Act
FET	F=Fuses, E=Emergency, T=Triangles
FMCSA	Federal Motor Carrier Safety Administration
FMCSR	Federal Motor Carrier Safety Regulations
FMVSS	Federal Motor Vehicle Safety Standards
GVW	Gross Vehicle Weight

HBV	Hepatitis-B Virus
HIV	Human Immunodeficiency Virus
HOV	High-Occupant Vehicles
I-C-D	I=Inflation, C=Condition, D=Tread Depth
IED	Improvised Explosive Device
IDEA	Individuals with Disabilities Education Act
IEP	Individual Education Plan
IFSP	Individual Family Support Plan
LEA	Local Education Agencies
LRE	Least Restrictive Environment
NHTSA	National Highway Traffic Safety Administration
NAC	Nevada Administrative Code
NRS	Nevada Revised Statutes
NSST	National Standards for School Transportation
NTSB	National Traffic Safety Board
OSA	Obstructive Sleep Apnea
OSHA	Occupational Safety and Health Act
PSI	Pounds per Square Inch
SAE	Society of Automotive Engineers
WTORS	Wheelchair Tie-down Occupant Restraint System