



STATE OF NEVADA



SCHOOL BUS DRIVER TRAINING MANUAL 2020

NEVADA STATE BOARD OF EDUCATION

2020-2021 MEMBERS

Elaine Wynn, President
Mark Newburn, Vice President
Felicia Ortiz
Robert Blakely
Tamara Hudson
Katherine Dockweiler
Kevin Melcher
Dawn Etcheverry Miller
Wayne Workman
Cathy McAdoo
Alex Gallegos, Student Representative

VISION STATEMENT

All Nevadans ready for success in the 21st Century

MISSION

To improve student achievement and educator effectiveness by ensuring opportunities, facilitating learning, and promoting excellence.

PURPOSE

NRS 385.075 requires the State Board establish policies to govern the administration of all functions of the State relating to supervision, management and control of public schools not conferred by law on some other agency. NRS 392.380 requires the State Board adopt regulations for school bus driver qualifications and training. The Nevada School Bus Driver Training Manual is the State Board of Education approved training document for all school bus drivers in Nevada. The manual was approved during the **October 8, 2020** Nevada State Board of Education meeting.

NEVADA DEPARTMENT OF EDUCATION

Jhone M. Ebert
Superintendent of Public Instruction

Dr. Jonathan P. Moore, Ed.D
Deputy Superintendent for Student Achievement

Heidi Haartz
Deputy Superintendent for Business & Support Services

Felicia Gonzales
Deputy Superintendent for Educator Effectiveness and Family
Engagement

Christy McGill
Director, Office for a Safe and Respectful Learning Environment

Jennah Fiedler
Program Officer, Pupil Transportation

ACKNOWLEDGEMENTS

The Nevada Department of Education acknowledges and thanks the following Nevada school districts, private and charter School transportation personnel for their hard work and dedication in the development of the Nevada School Bus Driver Training Manual.

Churchill County School District
Clark County School District
Douglas County School District
Elko County School District
Esmeralda County School District
Eureka County School District
Lincoln County School District
Lyon County School District
Mineral County School District
Nye County School District
Pershing County School District
Pyramid Lake
Storey County School District
Washoe County School District
White Pine County School District

Table of Contents

NEVADA STATE BOARD OF EDUCATION	1
2019-2020 MEMBERS	1
VISION STATEMENT	1
MISSION	1
PURPOSE	1
NEVADA DEPARTMENT OF EDUCATION	2
ACKNOWLEDGEMENTS	2
WHAT IS COMPARTMENTALIZATION	18
DANGER ZONES	12
SCHOOL BUS TYPES	13
SECTION 1: REQUIREMENTS TO BECOME A SCHOOL BUS DRIVER	15
COMMERCIAL DRIVER LICENSING (CDL) REQUIREMENTS	15
<i>When a CDL is Required</i>	15
<i>When a CDL Is Not Required</i>	15
<i>CDL Required Testing & Endorsements</i>	15
<i>Entry-Level Driving Training Requirements (ELDT)</i>	16
<i>(Implementation Date February 7, 2020)</i>	16
<i>Commercial Learners Permit (CLP)</i>	16
<i>Renewing Your CDL</i>	17
<i>Boarder State Employees</i>	17
QUALIFICATIONS FOR SCHOOL BUS DRIVERS	17
<i>Who is Qualified?</i>	18
<i>Who is NOT Qualified (Disqualified)?</i>	18
<i>Other CDL Rules</i>	21
MEDICAL EXAMINATIONS	22
PHYSICAL QUALIFICATIONS	23
PHYSICAL PERFORMANCE TESTS	26
CONTROLLED SUBSTANCES AND ALCOHOL USE TESTING	26
<i>Required Testing</i>	26
DRUG & ALCOHOL CLEARINGHOUSE	27
DRIVER OUT-OF-SERVICE REGULATIONS	28
SECTION 2: SCHOOL BUS INSPECTIONS	30
WHY INSPECT MY SCHOOL BUS	30
INSPECTION TEST	30
REQUIRED INSPECTIONS	30
MAJOR COMPONENTS OF A PRE-TRIP INSPECTION	31
SCHOOL BUS INSPECTION CRITERIA	31
<i>Vehicle Overview/Approaching the School Bus</i>	31
<i>Engine Compartment (engine off)</i>	32
<i>Cab Check/Engine Start</i>	33
EXTERNAL INSPECTION	38
SCHOOL BUS INSPECTION CRITERIA	43
WHEELCHAIR LIFT EQUIPPED BUSES (OOS)	45

<i>AFTER-TRIP VEHICLE INSPECTION</i>	47
<i>POST-TRIP INSPECTION REQUIREMENTS</i>	47
<i>SECURITY INSPECTION-ANYTIME THE BUS IS LEFT UNATTENDED</i>	47
INSPECTION CRITERIA DESCRIPTIONS	48
SECTION 3: BASIC DRIVING LAWS	55
SIGNS	55
<i>Standard Colors</i>	55
<i>RED – stop</i>	55
<i>Standard Shapes</i>	55
<i>Standard Signs</i>	55
<i>Construction and Maintenance Signs</i>	57
SIGNALS	58
HIGHWAY MARKINGS	59
CONTROLLING SPEED.....	61
RIGHT-OF-WAY	63
<i>Vehicle Right-of-Way Rules</i>	63
<i>Bicycle Right-of-Way Rules</i>	64
<i>Pedestrian Right-of-Way Rules</i>	65
FREEWAY DRIVING.....	66
<i>Entering a Freeway</i>	66
<i>Exiting a Freeway</i>	68
RAMP METERS, HIGH OCCUPANCY VEHICLE (HOV) LANES AND ROUNDABOUTS.....	68
<i>Ramp Meters</i>	68
<i>High Occupancy Vehicle (HOV) Lanes</i>	69
<i>Roundabouts</i>	69
SIGNALING, TURNING, LANE CHANGES AND PASSING.....	71
<i>Signaling</i>	71
<i>Turning</i>	71
<i>Lane changes</i>	72
<i>Passing</i>	73
SCHOOL AREAS AND SCHOOL ZONES.....	76
<i>Speed Limit in School Zones</i>	76
<i>Safety Zones</i>	76
<i>Passing and U-Turns in School Zones</i>	77
SECTION 4: SCHOOL BUS DRIVER RESPONSIBILITIES, DUTIES & REQUIRED KNOWLEDGE & SKILLS.....	77
SCHOOL BUS DRIVER RESPONSIBILITIES.....	77
ADDITIONAL NEVADA REQUIREMENTS	78
SCHOOL BUS DRIVER DUTIES	80
REQUIRED KNOWLEDGE AND SKILLS	81
<i>Required Knowledge</i>	81
<i>Required Skills</i>	87
REQUIRED ENDORSEMENTS FOR SCHOOL BUS DRIVERS	90
SECTION 5: BASIC CONTROL OF YOUR SCHOOL BUS.....	91
ACCELERATING	91
BACKING SAFELY	91
STOPPING THE BUS	93
TURNING THE BUS AROUND	94
COMMUNICATING.....	94
<i>Signaling your Intentions</i>	94
CONTROLLING SPEED.....	97

<i>The Effect of Speed on Stopping Distance</i>	99
<i>The Effect of Vehicle Weight on Stopping Distance</i>	99
<i>Speed and Curves</i>	99
<i>Speed and Distance Ahead</i>	100
<i>Speed and Traffic Flow</i>	100
<i>Speed on Downgrades</i>	100
<i>Matching Speed to the Road Surfaces</i>	101
SLIPPERY SURFACES	101
<i>Identifying Slippery Surfaces</i>	101
<i>Hydroplaning</i>	102
MAXIMUM SPEED LIMITS FOR SCHOOL BUSES	102
MANAGING SPACE	103
<i>Space Ahead</i>	103
<i>Space Behind</i>	104
<i>Space to the Sides</i>	104
<i>Space Cushion</i>	105
<i>Space Overhead</i>	105
<i>Space for Turns</i>	106
<i>Space Needed to Cross or Enter Traffic</i>	107
ADDITIONAL DRIVING REQUIREMENTS FOR SCHOOL BUS DRIVERS	107
USING YOUR MIRRORS.....	108
<i>Types of Mirrors on School Buses</i>	108
<i>Developing Good Mirror Use</i>	112
WHEN VEHICLES ARE REQUIRED TO STOP FOR SCHOOL BUSES	112
<i>Definition of a Divided Highway</i>	113
SECTION 6: HAZARDOUS DRIVING.....	114
DISTRACTED DRIVING	114
<i>Effects of Distracted Driving</i>	115
<i>Types of Distractions</i>	115
<i>Don't Drive Distracted</i>	115
COMMUNICATION DEVICES.....	116
<i>Two-Way Communication Devices</i>	116
<i>Cell/Mobile Phones/Tablets/Texting</i>	116
HAZARDOUS CONDITIONS	118
<i>Aggressive Drivers/Road Rage</i>	118
<i>Don't be an Aggressive Driver</i>	118
<i>What to do When Confronted by an Aggressive Driver</i>	119
<i>Move-Over Laws</i>	119
<i>Driving at Night</i>	120
<i>Driving in Fog</i>	124
<i>Driving in Winter</i>	125
<i>Driving in High Winds</i>	128
<i>Driving in Hot Weather</i>	129
<i>Driving in Mountains</i>	130
TAIL SWING	132
DEFENSIVE DRIVING.....	133
<i>Steering to Avoid a Crash</i>	133
<i>Stopping Quickly and Safely</i>	135
<i>Brake Failure</i>	136
<i>Proper Braking Technique</i>	136
<i>Tire Failure</i>	137
RAILROAD CROSSINGS	138

<i>Signs & Signals at Railroad Crossings</i>	138
<i>Active Signal Devices at Railroad Crossings</i>	141
PROCEDURES FOR CROSSING RAILROAD TRACKS	142
<i>Approaching the Crossing</i>	142
<i>At the Crossing</i>	143
<i>Crossing the Track</i>	144
<i>Special Situations at Railroad Crossings</i>	145
<i>Mandatory Emergency Evacuations at Railroad Crossings</i>	146
<i>Requirements to Practice Emergency Evacuation Drills</i>	146
<i>Evacuation Procedures</i>	147
<i>Disqualification for Railroad-Highway Crossing Violations</i>	147
SECTION 7: LOADING AND UNLOADING ZONE	149
DANGER ZONE	149
THE LOADING AND UNLOADING ZONE	150
<i>REPORTS OF FATALITIES BY STATE 2016-2017</i>	150
ILLEGAL PASSING OF THE SCHOOL BUS.....	151
<i>Illegal Passing Statistics</i>	151
<i>When Passing Vehicles are Required to Stop</i>	152
<i>Definition of a Divided Highway</i>	152
<i>Penalties for Stop Arm Violations</i>	153
<i>Report by a School Bus Driver of a Stop Arm Violation</i>	153
SYSTEM OF LIGHTS, STOP ARMS AND CROSSING CONTROL ARM	153
<i>Alternating Flashing Amber/Yellow Lights</i>	154
<i>Alternating Flashing Red Lights, Stop Arms and Crossing Control Arm</i>	154
<i>White Flashing Strobe Light (Optional)</i>	155
SCHOOL ZONES AND SCHOOL CROSSING ZONES	155
<i>School Zones</i>	155
<i>School Crossing Zones</i>	156
<i>U-Turns and Passing in a School Zone or School Crossing Zone</i>	156
<i>Move-Over Laws</i>	157
LOADING AND UNLOADING PROCEDURES	158
<i>Approaching the Stop</i>	158
<i>When Stopping</i>	159
<i>Loading Procedures</i>	160
<i>Unloading Procedures</i>	161
1. <i>Activate your turn signal, 100 feet in residential and 300 feet on highways and get into the right lane far in advance of the stop. Have the students remain seated until told to exit.</i>	162
<i>Additional Procedures for Student That Must Cross the Road</i>	163
<i>Loading and Unloading Procedures at School</i>	165
<i>Special Dangers in the Loading and Unloading Zone</i>	167
<i>Preventing Incidents in the Loading and Unloading Zone</i>	168
LAP/SHOULDER RESTRAINT SYSTEMS IN SCHOOL BUSES	169
<i>Student Seat Belt Usage</i>	170
<i>Proper Use of 3-Point Lap Shoulder Belts</i>	171
<i>Improper Use of 3-Point Lap Shoulder Belts</i>	172
LEAVING STUDENTS ON THE SCHOOL BUS.....	173
<i>Why Students are Left on the Bus</i>	174
<i>Consequences for School Bus Drivers Who Leave Children on the Bus</i>	174
<i>Steps for Preventing Leaving Students behind</i>	175
SECTION 8: STUDENT MANAGEMENT	177
STEPS FOR APPROPRIATE STUDENT MANAGEMENT	177

<i>children are not getting along, separate them.</i>	178
<i>When there is a problem</i>	178
STUDENT RESPONSIBILITIES.....	179
STUDENT RULES	180
QUIET TIME	182
MUSIC ON THE BUS	182
VIDEO MONITORING SYSTEMS	183
TRANSPORTING HOMELESS CHILDREN	183
<i>McKinney-Vento Homeless Assistance Act</i>	183
<i>Definition of Homeless Children and Youth</i>	183
<i>Summary of Key Provisions of McKinney-Vento</i>	184
<i>School Bus Drivers and Homeless Students</i>	185
SECTION 9: SECURITY, SAFETY, REPORTING & CONFIDENTIALITY.....	185
SECURITY.....	185
<i>Identifying Security Threats</i>	186
<i>Responding to a Security Incident</i>	187
<i>Security Inspection</i>	188
SAFETY	189
<i>Safe and Respectful Learning Environments</i>	189
<i>A Safe Learning Environment</i>	190
<i>Threatening or Assaulting an Employee or Student</i>	191
SEXUAL MISCONDUCT WITH STUDENTS	192
MANDATORY REPORTING.....	192
<i>Requirements for Reporting</i>	192
<i>Requirements for Reporting Suspected Child Abuse</i>	193
<i>How to Report Violations</i>	193
<i>Immunity from Reporting</i>	194
<i>Failure to Report</i>	194
<i>Immunity from Civil or Criminal Liability</i>	194
<i>SafeVoice</i>	194
CONFIDENTIALITY	194
<i>Family Educational Rights and Privacy Act (FERPA)</i>	195
<i>Health Insurance Privacy and Portability Act (HIPPA)</i>	195
<i>Employee Confidentiality</i>	196
SECTION 10: EXTRA- CURRICULAR ACTIVITY AND FIELD TRIPS	197
ON-DUTY TIME AND HOURS-OF-SERVICE REGULATIONS.....	197
<i>On-Duty Time Includes</i>	197
<i>What is Not Considered On-Duty Time</i>	198
<i>Hours-of-Service Rules</i>	198
MAXIMUM SPEED LIMITS FOR SCHOOL BUSES ON EXTRA-CURRICULAR ACTIVITIES	199
PLANNING FOR AN EMERGENCIES.....	200
<i>DRILLS TO PRACTICE EVACUATION</i>	200
PLANNING THE TRIP	201
<i>EMERGENCY PLANNING FOR THE TRIP</i>	203
<i>EXTRA RISKS WITH ACTIVITY TRIPS</i>	204
SECTION 11: EMERGENCY EQUIPMENT AND PROCEDURES.....	205
EMERGENCY EQUIPMENT.....	205
<i>Alternating Flashing Yellow & Red Lights</i>	205
<i>Belt Cutters</i>	206
<i>First Aid Kit</i>	206

<i>Body Fluid Clean-Up Kit</i>	206
<i>Emergency Warning Devices</i>	207
<i>Fire Extinguishers</i>	207
<i>Spare Fuses</i>	208
EMERGENCY PROCEDURES	208
<i>Emergency Evacuation Procedures</i>	208
<i>Emergency Warning Devices</i>	209
<i>Fire Extinguisher</i>	211
<i>How to Operate a Fire Extinguisher</i>	212
EMERGENCY EVACUATION PROCEDURES	212
<i>Emergency Evacuation Procedures</i>	212
CRASH PROCEDURES	217
BREAKDOWNS	218
DUTY TO RENDER AID	218
PROCEDURES FOR RENDERING AID	219
NEVADA'S GOOD SAMARITAN LAW	219
UNIVERSAL STANDARDS	219
<i>First Steps in Providing First Aid</i>	219
<i>Universal Standards for the Spread of Infectious Diseases by Body Fluids</i>	220
<i>Body Fluid Clean-Up Kit</i>	220
MEDICAL EMERGENCIES	221
SECTION 12: TRANSPORTING STUDENTS WITH SPECIAL NEEDS	223
LAWS AFFECTING TRANSPORTATION FOR STUDENTS WITH SPECIAL NEEDS	223
TERMS AND DEFINITIONS	225
INDIVIDUALIZED EDUCATION PROGRAM (IEP)	226
TRANSPORTATION AS A RELATED SERVICE	227
CATEGORIES OF DISABILITIES DEFINED - AGE 3 THROUGH 21	228
STUDENT BEHAVIOR	231
UNIQUE CHARACTERISTICS	232
COMMUNICATION	233
<i>Communicating with the Team</i>	233
<i>Communicating with Your Transportation Supervisor</i>	233
<i>Communicating with Parents and Caregivers</i>	234
<i>Communicating with Special Needs Students</i>	235
<i>Communicating in Emergencies</i>	236
SPECIALIZED ASSISTIVE EQUIPMENT	237
TRANSPORTING SPECIALIZED ASSISTIVE EQUIPMENT	237
<i>Transporting Oxygen</i>	237
<i>Transporting Service Animals</i>	238
<i>Wheelchair Tie-down Occupant Restraint System (WTORS)</i>	242
<i>Storage of Specialized Equipment</i>	243
WHEELCHAIRS	244
<i>Wheelchair Characteristics</i>	245
<i>Power Wheelchairs</i>	246
<i>Tilt 'n Space Wheelchair</i>	247
<i>WC 19 Wheelchairs</i>	247
<i>WC19 Wheelchair Symbols</i>	248
WHEELCHAIR LIFTS	249
<i>Components of a Wheelchair Lift</i>	249
<i>Wheelchair Lift Safety Features</i>	249
<i>Wheelchair Lift Out-of-Service</i>	251
<i>Who Can Use a Wheelchair Lift</i>	251

LOADING AND SECURING THE WHEELCHAIR	252
<i>School Bus Position</i>	252
<i>Loading the Wheelchair</i>	252
<i>Placement of Students</i>	254
<i>Federal Standards for Wheelchair Securement Systems</i>	256
<i>Securing the Wheelchair</i>	256
<i>The Do and Do Nots of Securing a Wheelchair</i>	260
GENERAL GUIDELINES FOR DRIVER'S OF STUDENTS WITH SPECIAL NEEDS	262
<i>Emergency Evacuation Drills</i>	263
<i>Emergency Evacuation Plan</i>	263
<i>General Rules on How to Handle an Emergency</i>	264
<i>Lift Techniques for Evacuating Students</i>	265
BUS AIDES AND ATTENDANTS.....	268
EXTENDED SCHOOL YEAR (ESY).....	269
SECTION 13: TRANSPORTING TODDLERS AND PRE-SCHOOL CHILDREN	270
INTRODUCTION	270
DEFINITIONS	271
TRANSPORTATION SERVICES FOR PRESCHOOL CHILDREN WITH DISABILITIES	271
DRIVER AND AID KNOWLEDGE AND RESPONSIBILITY	271
CHILD SAFETY RESTRAINT SYSTEMS (CSRS).....	272
<i>Elements to Correctly Install CSRS</i>	272
<i>Convertible CSRS (Rear-Facing)</i>	273
<i>Convertible CSRS (Forward-Facing)</i>	274
<i>Car Beds</i>	274
<i>Specialized Positioning Seats</i>	275
<i>Booster Safety Seats (Belt Positioning Boosters Only)</i>	275
<i>Safety Vests</i>	275
EMERGENCY EVACUATION PROCEDURES FOR INFANTS, TODDLERS AND PRESCHOOL AGE CHILDREN	276
ACRONYMS	277

NEVADA COUNTIES/SCHOOL DISTRICTS

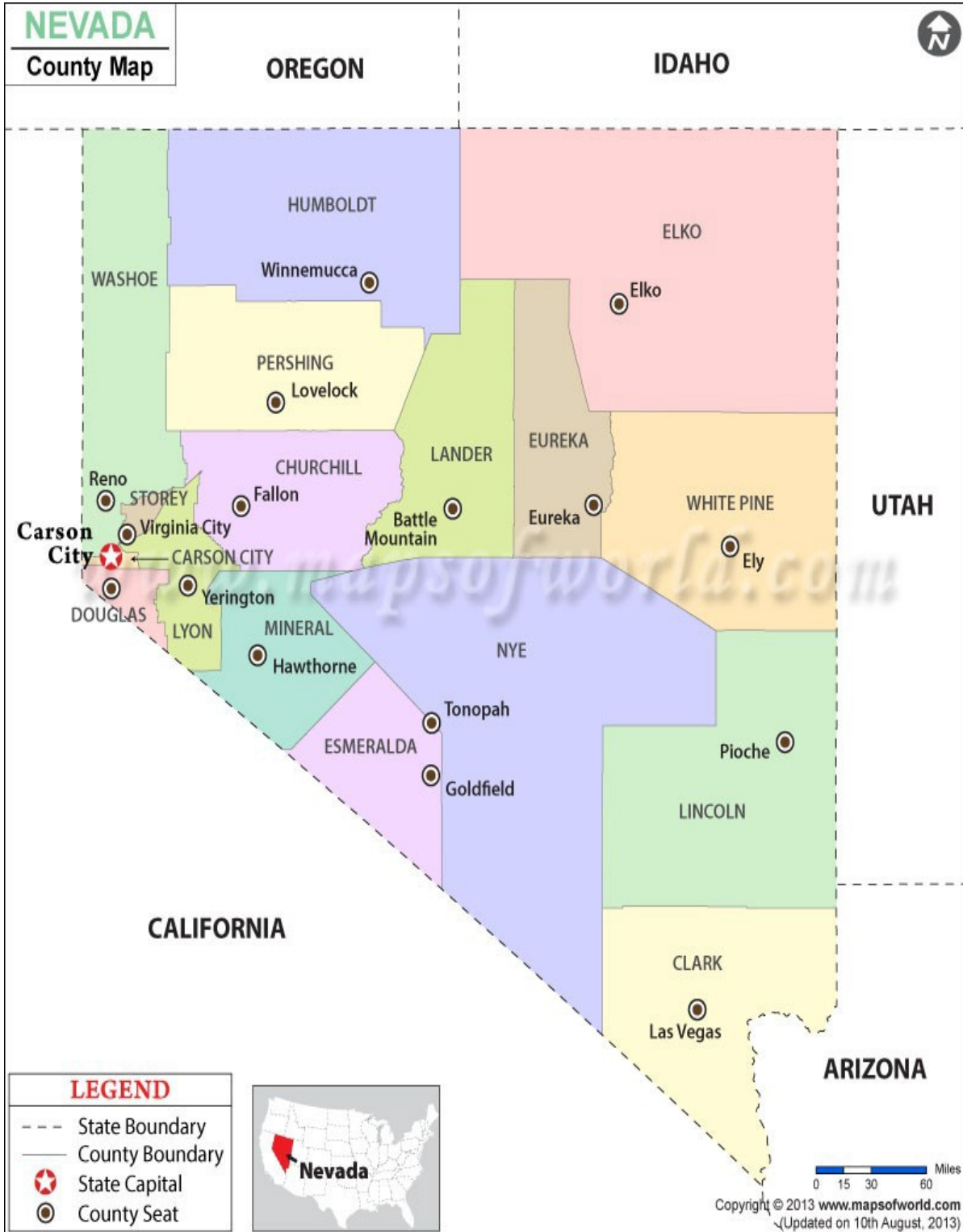

WHAT IS COMPARTMENTALIZATION

Compartmentalization in school buses is the design concept of using tall seat backs, padded with energy-absorbing construction covering all metal parts, and spacing that is closer than typically found in passenger vehicles.

The arguments in favor of continuing the use of compartmentalization in school buses does have some favorable points. While it appears that children sitting on a bus without seat belts would be unsafe in the event of an accident, large school buses are very heavy and can diminish some of the effects of crash forces as opposed to passenger cars and trucks. The high-backed seats placed closely together with padded seating have helped to avoid occupant injuries in the following ways:

1. Padded Protection – All surfaces of school bus seats are padded with energy-absorbing material to provide protection, especially when child occupants are displaced during an accident. The entire bench is well padded, leaving no surfaces that are likely to cause injury. In addition, seat legs are securely anchored.
2. Whiplash Prevention – Whiplash is one of the most common injuries sustained while wearing a seat belt. This injury is almost completely prevented with a compartmentalized seating system because there are no seat belts to cause this type of injury.
3. Less Space to Move – Compartmentalized seating is close together, acting as a means of containment. There is less room for children to be moved or thrown about in the event of an accident.
4. Seat Belts Can Injure – Even the best seat belts can cause injury, including whiplash. Shoulder harnesses are the best choice for child restraint if properly adjusted.

DANGER ZONES

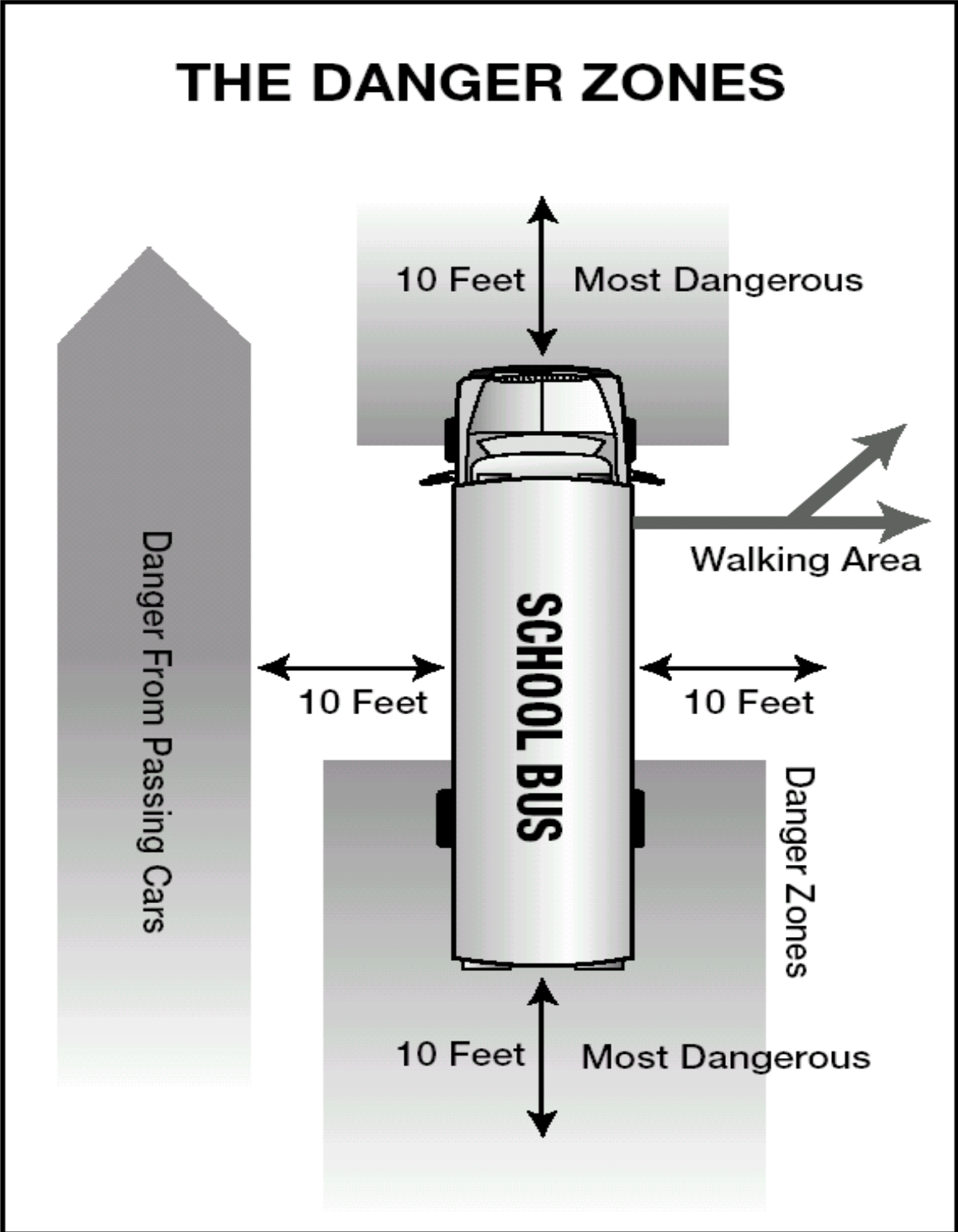

[Nevada Commercial Driver License Manual](#) (p. 10-1)

SCHOOL BUS TYPES

School Bus: A bus owned, leased, contracted to or operated by a school district and regularly used to transport students to and from school or school-related activities, but not including a charter bus or transit bus. A school bus must meet all applicable Favas and is readily identified by alternately flashing lamps, National School Bus Yellow paint, and the legend "School Bus," except as may be provided for the multifunctional school activity bus (MFSAB). The following describes each of these types and styles of vehicle.

Type A: A Type "A" school bus is a conventional or bus constructed utilizing a cutaway front section vehicle with a left side driver's door. This definition includes two classifications:

Type A-1, with a Gross Vehicle Weight Rating (GVWR) of 14,500 pounds or less; and

Type A-2, with a GVWR greater than 14,500 and less than or equal to 21,500 pounds.



Type B: A Type "B" school bus is constructed utilizing a stripped chassis. The entrance door is behind the front wheels. This definition includes two classifications: **Type B-1,** with a GVWR of 10,000 pounds or less; and

Type B-2, with a GVWR greater than 10,000 pounds.



Type C: A Type “C” school bus is constructed utilizing a chassis with a hood and front fender assembly. The entrance door is behind the front wheels; also known as a *conventional school bus*. This type also includes cutaway truck chassis or truck chassis with cab with or without left side door and a GVWR greater than 21,500 pounds.



Type D: A Type “D” school bus is constructed utilizing a stripped chassis. The entrance door is ahead of the front wheels; also known as *rear engine transit style school buses*.



Multifunctional school activity bus (MFSAB): A school bus whose purposes do not include transporting students to and from home or school bus stops, as defined in [Federal Motor Vehicle Safety Standard 571.3, Definitions](#). This subcategory of school bus meets all Federal Motor Vehicle Safety Standards for school buses except the traffic control requirements (alternately flashing signal and stop arm).

SECTION 1: REQUIREMENTS TO BECOME A SCHOOL BUS DRIVER

COMMERCIAL DRIVER LICENSING (CDL) REQUIREMENTS

When a CDL is Required

You must have a CDL to operate:

1. Any vehicle with a gross vehicle weight rating (GVWR) of 26,001 pounds or more (Class A, B or C).
2. Any vehicle designed to transport 16 or more passengers, including the driver (Class C).
[Nevada Commercial Driver License Manual](#), (pg. 1-1)

When a CDL Is Not Required

A CDL is not required for a Type A school bus that is designed to transport 16 passengers or less, including the driver. [Federal Motor Carrier Safety Regulation, Classes of License and Commercial Learner's Permits](#)

CDL Required Testing & Endorsements

You will be required to complete the following tests:

1. Vision Testing
2. CDL Knowledge Tests:
 - a. General knowledge test;
 - b. Passenger test (P);
 - c. School bus test (S); and
 - d. Air-brake test. (if vehicle has air brakes).
3. CDL Skills Exam:

- a. Vehicle inspection;
- a. Basic vehicle control; and
- b. On-road driving test.
[Nevada Commercial Driver License Manual](#), (pg. 1-2)

Entry-Level Driving Training Requirements (ELDT) (Implementation Date February 7, 2020)

1. ELDT requirements apply to:
 - a. An individual who applies, for the first time, for a Class A or Class B CDL, or who upgrade to a class A or B CDL; or
 - b. An individual seeking to obtain a passenger (P) and/or school bus endorsement for the first time.
[Federal Motor Carrier Safety Regulation 380.609, General entry-level driver training requirements](#)
2. In order to provide training to an entry-level driver, you will be required to meet all requirements and be listed on the [Federal Motor Carrier Safety Administration's Entry-Level Driver Training \(ELDT\) Registry](#).
3. Once a driver-trainee completes training administered by a provider listed on the Training Provider Registry, the provider must, by midnight of the second business day after the driver-trainee completes training, electronically transmit training certification information through the Trainer Provider Registry.
[Federal Motor Carrier Safety Administration 380.77, Training Certification](#)

Commercial Learners Permit (CLP)

A CLP is issued for a 180-day period for entry-level driver training on public roads or highways. Applicants must be at least 21 years old and pass the vision and all required written examinations.

1. Drivers with a CLP must be accompanied at all times by a driver who:
 - a. Is at least 25 years of age;

- b. Holds a CDL for the proper class and endorsements; and
- c. Is seated next to the driver. In school buses, the instructor must be seated in the first seat to the right of the driver.

[Nevada Commercial Driver License Manual](#), (pg. iii)

2. School bus drivers that hold a current Commercial Driver License with required endorsements must:

- a. Receive training in the operation of a school bus from a state certified school bus driver trainer.
- b. Training must be provided while the school bus is not occupied by pupils.

[Nevada Administrative Code 386.530](#)

Renewing Your CDL

It is your responsibility to renew your CDL prior to the expiration date. [Nevada Commercial Driver Manual](#), (pg. 18)

You are required to notify the DMV of any address or name changes within 30 days.

[Nevada Driver Handbook](#), (pg.19)

Boarder State Employees

A boarder state employee means a person whose legal residence is not in this State, who resides outside of the State of Nevada and commutes on a daily basis into the State of Nevada for the solely for the purposes of employment at a place of employment which is less than 35 air miles from the state border. [Nevada Revised Statute 482.012](#)

QUALIFICATIONS FOR SCHOOL BUS DRIVERS

Federal regulations require that you must be qualified to drive a CMV. Your employer cannot require or permit you to drive a CMV unless you are considered qualified.

Who is Qualified?

You are considered qualified to drive a CMV if you are:

1. At least 21 years old;
2. Can read and speak the English language sufficiently to converse with the general public, understand highway traffic signs and signals in the English language, respond to official inquiries, and make entries on reports and records.
3. Can, by reason of experience, training, or both, safely operate the CMV you drive;
4. Physically qualified to drive a CMV. You will be required to provide a current Medical Examiner's Certificate;
5. Have a current, valid CMV license issued by only one state;
6. Have provided your employer with a list of all violations; and
7. Is not disqualified to drive a CMV.
[Federal Motor Carrier Safety Regulation 391.11, General Qualifications of Drivers](#)

Who is NOT Qualified (Disqualified)?

You cannot drive a CMV if you are disqualified for any of the following reasons.

1. Operating a CMV with a blood alcohol concentration (BAC) of .04% or more. If you operate a CMV, you shall be deemed to have given consent to alcohol testing. [Federal Motor Carrier Safety Regulations 383.72, Implied Consent to Alcohol Testing](#)
2. Driving a non CMV with a BAC of 0.08% or more.
3. Refusing to undergo required blood alcohol testing

Some over the counter medications can cause a positive test.

4. Driving while under the influence (even if prescribed) of a controlled substance.

You are required to notify your employer immediately if you are charged with Driving under the influence of alcohol or drugs.

5. Leaving the scene of a crash while operating a CMV.
6. Committing a felony involving the use of a CMV.
7. Driving a CMV when your CDL is suspended, revoked, withdrawn or denied.
8. Causing a fatality through negligent operation of a CMV.
9. Committing Serious Traffic Violations that include:
 - a. Excessive speeding (15 mph or more above the posted speed limit);
 - b. Reckless driving;
 - c. Improper or erratic lane changes;
 - d. Following a vehicle too closely;
 - e. Traffic offenses committed in a CMV in connection with a fatal traffic crash; and
 - f. Driving a CMV without the proper class of CDL and/or endorsement.
[Nevada Commercial Driver License Manual](#), (pg. 1-8)
10. Violation of a Railroad-highway Grade Crossing. These violations include:
 - a. For drivers who are not required to always stop, failing to slow down and check that the tracks are clear of an approaching train.
 - b. For drivers who are always required to stop, failing to stop before driving onto the crossing.

- c. Failing to have sufficient space to drive completely through the crossing without stopping.
 - d. Failing to obey a traffic control device or the directions of an enforcement official at the crossing.
 - e. Failing to negotiate a crossing because of insufficient undercarriage clearance.
- [Nevada Commercial Driver License Manual](#), (pg. 1-8)

11. Traffic Violations in your personal vehicle will result you being disqualified to operate a CMV.

- a. If your privilege to operate your personal vehicle is revoked, cancelled, or suspended due to violations of traffic control laws.
 - b. If your privilege to operate your personal vehicle is revoked, cancelled, or suspended due to alcohol, controlled substance or felony violations, you will lose your CDL for 1 year. If you are convicted of a second violation in your personal vehicle or CMV, you will lose your CDL for life.
 - c. If your license to operate your personal vehicle is revoked, cancelled, or suspended you may not obtain a "hardship" license to operate a CMV.
- [Nevada Commercial Driver License Manual](#), (pg. 1-8)

You will lose your CDL for at least 60 days for your first railroad grade crossing violation, and at least 120 days for the second violation and one year for a third violation.

[Nevada Commercial Driver License Manual](#), (pg. 1-8)

Other CDL Rules

1. You cannot have more than one license.
2. You must notify your employer within 30 days of conviction for any traffic violation (except parking). This is true no matter what type of vehicle you were driving.
3. You must notify DMV within 30 days if you are convicted in any other jurisdiction of any traffic violation (except parking). This is true no matter what type of vehicle you were driving.
4. You must notify your employer within two business days if your license is suspended, revoked, or canceled, or if you are disqualified from driving.
5. You must give your employer information on all driving jobs you have held for the past 10 years.
6. You cannot drive a CMV without a current, valid CDL with all required endorsements.
7. All states are connected to one computerized system to share information about CDL drivers.
8. You will be disqualified for using a mobile telephone to conduct a voice communication or dial a mobile telephone while operating a CMV.
9. You will be disqualified for sending or reading text messages while operating a CMV.
10. You must be properly restrained by a safety belt at all times while operating a CMV.
[Nevada Commercial Driver License Manual](#), (pg.1-9)
11. At least every 12 months, your employer will require you to obtain or consent to obtain your driving record from DMV.
[Federal Motor Carrier Safety Regulation 391.25, Annual Inquiry and Review of Driving Record](#)

Driving means operating a CMV, with the motor running, including while temporarily stationary because of traffic, a traffic control device, or other momentary delays.

[Federal Motor Carrier Safety Regulation 392.80, Prohibition Against Texting](#), (c)

MEDICAL EXAMINATIONS

1. All Nevada school bus drivers must be physically examined by a Federally Certified Registered Medical Examiner. [Federal Motor Carrier Safety Regulation, National Registry of Certified Medical Examiners](#)
2. Select that you are an **INTERSTATE, NON-EXCEPTED** driver. Interstate, non-excepted drivers are required to submit a DOT medical certificate. Please be aware that if you self-certify incorrectly, you will be required to return to DMV and change your status, including paying any fees required by DMV.
3. Provide your current medical certificate to DMV. [Federal Motor Carrier Safety Regulation 391.41, Physical Qualifications for Drivers](#). The Department of Motor Vehicles will suspend the driver's license of any person who fails to submit a required medical examination within 15 days after it is requested. [Nevada Administrative Code 483.320](#)
4. CMV drivers with medical waivers will not be issued School bus endorsement in Nevada.
5. Your employer can request you be reexamined if there are concerns about your ability to operate a CMV.

It is your responsibility to make sure that DMV has your Medical Examiner Certificate prior to the expiration date.

[Nevada Commercial Driver License Manual](#), (pg. ii)

PHYSICAL QUALIFICATIONS

You are physically qualified to drive a school bus if there is NO impairment of any of the following.

1. A hand or finger which interferes with prehension or power grasping.
2. An arm, foot, or leg which interferes with the ability to perform tasks associated with operating a CMV; or any significant limb defect or limitation which interferes with the ability to perform normal tasks associated with operating a CMV.
3. Has no established medical history or clinical diagnosis of diabetes mellitus which currently requires insulin injections for control unless the person meets the requirements in [Federal Motor Carrier Safety Regulation 391.46, Physical Qualification Standards for an Individual with Diabetes Mellitus Treated with Insulin for Control](#).
 - a. Prior to the examination required by FMCSA 391.45 or the expiration of a medical examiner's certificate, the individual must be evaluated by his or her "treating clinician." A treating clinician means a healthcare professional who manages, and prescribes insulin for the treatment of diabetes mellitus.
 - b. During the evaluation of an individual, the treating clinician must complete the [Federal Motor Carrier Safety Regulation, Insulin-Treated Diabetes Mellitus Assessment Form MCSA-5870](#).
 - c. At least annually, but no later than 45 days after the treating clinician signs and dates the Insulin-Treated Diabetes Mellitus Assessment Form (MCSA-5870) certifying that the driver has been medically examined and is free of complications from diabetes mellitus that might impair his or her ability to operate a CMV safely.
 - d. An individual is not physically qualified on a permanent basis if he or she has either severe non-proliferation diabetic retinopathy or proliferative diabetic retinopathy.
 - e. An individual is not physically qualified to operate a CMV up

to the maximum 12-month period until he or she provides the treating clinician with at least 3 months of electronic blood glucose self-monitoring records while being treated with insulin.

- f. An individual who does not provide the treating clinician with at least the preceding 3 months of electronic blood glucose self-monitoring records while being treated with insulin is not physically qualified to operate CMV for more than 3 months.
- g. An individual with diabetes mellitus treated with insulin for control experiences a several hypoglycemic episode is prohibited from operating a CMV. You must report such occurrence to your treating clinician and you must be evaluated again as soon as possible.
- h. A severe hypoglycemic episode is one that requires the assistance of others, or results in loss of consciousness, seizure, or coma.

[Federal Motor Carrier Safety Regulation 391.46, Physical Qualification Standards for an Individual with Diabetes Mellitus Treated with Insulin for Control.](#)

- 4. Has no current clinical diagnosis of myocardial infraction, angina pectoris, coronary insufficiency, thrombosis, or any other cardiovascular disease of a variety known to be accompanied by syncope, dyspnea, collapse, or congestive cardiac failure.

OSA is a respiratory dysfunction and medical examiners can require an OSA test if a driver exhibits symptoms or multiple risk factors.

[Federal Motor Carrier Safety Regulation, Bulletin to Medical Examiners on OSA](#)

- 5. Has no established medical history or clinical diagnosis of a respiratory dysfunction that is not currently being managed with a medical professional likely to interfere with the ability to control and drive a CMV. This includes *Obstructive Sleep Apnea* (OSA).

6. Has no established medical history or clinical diagnosis of rheumatic, arthritic, orthopedic, muscular, neuromuscular, or vascular disease.
7. Has no established medical history or clinical diagnosis of epilepsy or any other condition that could cause the loss of consciousness.
8. Has no mental, nervous, organic or functional disease or psychiatric disorder likely to interfere with the ability to drive a CMV safely.
9. Has distance vision acuity of at least 20/40 in each eye without corrective lenses or visual acuity separately corrected to 20/40 or better with corrective lenses, distant binocular acuity of at least 20/40 in both eyes with or without corrective lenses, field of vision of at least 70 degrees in the horizontal Meridian in each eye, and the ability to recognize the colors or traffic signals and devices showing standard, red, green and amber.
10. First perceives a forced whispered voice in the better ear at not less than 5 feet or without the use of a hearing aid or, if tested by use of an audiometric device. Does not have an average hearing loss in the better ear greater than 40 decibels at 500 Hz, 1,000 Hz and 2,000 Hz with or without a hearing aid when the audiometric device is calibrated to American National Standard.
11. Does not use any drug or substance identified in 21 CFR 1308.11 Schedule I, an amphetamine, a narcotic, or other habit-forming drug.
12. Does not use any non-Schedule I drug or substance that is identified in the other Schedules in 21 CFR part 1308 except when the use is prescribed by a licenses medical practitioner, as defined in 382.107, who is familiar with the driver's medical history and has advised the driver that the substance will not adversely affect the driver's ability to safely operate a commercial motor vehicle.
13. Has no current clinical diagnosis of alcoholism.
[Federal Motor Carrier Safety Regulation 391.41, Physical Qualifications for Drivers](#)

**Medical variances & waivers are not allowed
in Nevada for CDL drivers with a School Bus
Endorsement.**

PHYSICAL PERFORMANCE TESTS

The National Transportation Safety Board issued [Recommendation H-19-006](#) which requested states require drivers pass a physical performance test annually and anytime a driver's physical condition changes in a manner that could affect the driver's ability to physically perform school bus driver duties. Drivers, at a minimum, will be expected to be able to pass the following physical performance tests:

1. Climb and descend bus steps 3 times in 30 seconds;
 2. Demonstrate the ability to activate alternately the throttle and brake controls 10 times in 10 seconds;
 3. Depress and hold the brake and pedal a minimum of 3 seconds, 5 consecutive times;
 4. Manually open and close the bus entrance door 3 consecutive times;
 5. Demonstrated while the vehicle is in motion, with the driver operating a minimum of 2 hand controls on both sides of the steering wheel, while maintaining control of the vehicle at all times. Each response must be completed within 8 seconds;
 6. Starting in a seated position, leave the driver's seat and exit the bus from the rearmost floor level emergency door exit within 20 seconds;
 7. Demonstrate the ability to drag or carry a 100-pound object 30 feet in 30 seconds; and
 8. Any other performance skills test your school deems necessary to assure the driver can perform their duties.
- [New York State School Bus Driver Physical Performance Test Guidelines for School Bus Driver Instructors](#)

CONTROLLED SUBSTANCES AND ALCOHOL USE TESTING

Required Testing

All school bus drivers must submit to any of the following testing:

1. **Pre-Employment.** Prior to the first time driving, a driver shall undergo testing for controlled substances and the employer must receive a negative test result. [Federal Motor Carrier Safety Regulation 382.301, Pre-Employment Testing](#)
2. **Post-Accident.** An employer shall test for controlled substances and alcohol as soon as practical following a crash. [Federal Motor Carrier Safety Regulation 382.303, Post-Accident Testing](#)
3. **Random Testing.** Every driver shall submit to random controlled substance and alcohol testing. [Federal Motor Carrier Safety Regulation 382.305, Random Testing](#)
4. **Reasonable Suspicion.** Your employer shall require a driver to submit to an alcohol test when the employer has reasonable suspicion to believe the driver is under the influence. [Federal Motor Carrier Safety Regulation 382.307, Reasonable Suspicion Testing](#)

DRUG & ALCOHOL CLEARINGHOUSE

Effective January, 6, 2020, the [Federal Motor Carrier Safety Regulation, Drug & Alcohol Clearinghouse](#) will require the following:

1. FMCSA regulation employers to report to the Clearinghouse information related to violations of the drug and alcohol regulations under [Federal Motor Carrier Safety Regulation 382.701, Drug and Alcohol Clearinghouse](#).
2. Employers will be required to query the Clearinghouse for current and prospective employees' drug and alcohol violations before permitting those employees to operating a DMV on public roads.
3. Employers will be required to annually query the Clearinghouse for each driver they currently employ.

**You are not physically qualified to drive a CMV
if you use marijuana, even if prescribed.**

[Federal Motor Carrier Safety Administration, Medical
Marijuana FAQ's](#)

DRIVER OUT-OF-SERVICE REGULATIONS

School bus drivers can be placed out-of-service by their employer, law enforcement or inspectors. You will be placed out-of-service for any of the following violations:

1. Any driver who does not possess a valid CDL, including, but not limited to improper class, expired, cancelled, revoked, disqualified, suspended or withdrawn. [Federal Motor Carrier Safety Regulation 391.15, Disqualification of Drivers](#)
2. Any driver with a learners permit who is not accompanied by the holder of a valid CDL. Must also hold a valid automobile driver license or have a valid operator's status allowed by licensing jurisdiction. [Federal Motor Carrier Safety Regulation 383.25, Commercial Learner's Permit](#)
3. Any driver operating a school bus without corrective lenses or hearing aid as indicated on the driver's medical certificate. [Federal Motor Carrier Safety Regulation 391.11, General Qualifications of Drivers](#)
4. Any driver operating a school bus without possessing a valid medical certificate. [Federal Motor Carrier Safety Regulation 391.41, Physical Qualification for Drivers](#)
5. When a driver's ability or alertness is so impaired, or so likely to become impaired, through fatigue, illness, or any other cause that is likely to make it unsafe for him/her to begin or continue to operate CMV. [Federal Motor Carrier Safety Regulation 392.3, III or Fatigued Operator](#)
6. Any driver who violates Hours of Service laws:
 - a. Any driver who has driven more than 10 hours;
 - b. Any driver who has been on duty for 15 hours; [Nevada Revised Statute 386.815](#)
 - c. Any driver who has been on duty for more than 60 hours in 7 consecutive days;
 - d. Has no record of duty status (logbook) when required; or

- e. Provides a false record of duty status (log book). [Federal Motor Carrier Safety Regulation 395.8, Driver's Record of Duty Status](#)

Note: When a driver at the direction of the motor carrier is traveling, but has no direct responsibility to the carrier, the time is counted as on-duty time unless the driver is afforded at least 10 consecutive hour's off-duty when arriving at the destination. In this case the driver is off duty for the entire period. [Federal Motor Carrier Safety Regulation, 395.1 \(j\)](#)

Drivers who are traveling with the bus must count that time as on-duty.

SECTION 2: SCHOOL BUS INSPECTIONS

WHY INSPECT MY SCHOOL BUS

1. For the safety of your students.
2. Legally required by the [Federal Motor Carrier Safety Administration \(FMCSA\)](#), the [Nevada Department of Motor Vehicles \(DMV\)](#), and the Nevada State Board of Education and your school district.
3. Prevent crashes, breakdowns and reduce driver frustration.
4. Eliminate and reduce delays.
5. Prolong the life of the bus and reduces transportation costs.

INSPECTION TEST

In order to obtain a CDL, you will be required to pass a Vehicle Inspection test. You will be tested to see if you know whether your school bus is safe to drive. You will be asked to explain what you would inspect and why. [Nevada Commercial Driver License Manual](#), (pg. 11-1)

You need to inspect your school bus the same way each time so you learn all the steps and are less likely to forget anything.

While approaching your school bus, notice the general condition. Look for damage or bus leaning to one side. Look under the vehicle for fresh oil, coolant, grease, or fuel leaks. Check the area around the vehicle for hazards to vehicle movement (people, other vehicles, objects, low-hanging wires, limbs, etc.).

REQUIRED INSPECTIONS

1. Pre-trip (before the trip);
2. During a trip security inspection;
3. Post-trip, (after the trip/run/route and student check); and
4. Enroute/roadside vehicle inspections.

If you inspect your school bus the same way each time you will be less likely to miss anything.

MAJOR COMPONENTS OF A PRE-TRIP INSPECTION

You must be able to identify each safety-related part on the school bus and name, point to or touch and fully explain what needs to be inspected:

1. Vehicle Overview/Approaching the school bus;
2. Engine compartment (engine off);
3. Cab Check/Engine Start;
4. External Inspection;
5. Steering;
6. Suspension;
7. Brakes;
8. Wheels;
9. Side of vehicle;
10. Rear of vehicle;
11. Wheelchair lifts and securement systems (if equipped); and
12. School bus specific equipment.
[Nevada Commercial Driver License Manual](#), (pg. 11-1) and [Federal Motor Carrier Safety Regulation 383.113, Required Skills](#)

SCHOOL BUS INSPECTION CRITERIA

All criteria marked with an (OOS) means that this is an out-of-service item that requires the school bus be placed out of service.

Vehicle Overview/Approaching the School Bus

DRAFT

1. Review last vehicle inspection report. Drivers must inspect and report any violations. Your employer must repair any items in the report and certify that the required repairs have been made.
2. Observe the overall physical appearance and condition of the bus.
3. Look under the bus for fresh oil, coolant, grease, or fuel leaks on the ground.
4. Check the area around the bus for hazards, vandalism or tampering.

Engine Compartment (engine off)

1. Check that the parking brakes are on and/or the wheels are chocked before you do the following:
 - a. **Leaks & hoses** (OOS). Look for puddles on the ground, dripping fluids on underside of engine transmission. Inspect hoses for condition and leaks.
 - b. **Oil level**. Be able to indicate where dipstick is located, and that oil level is within safe operating range. Level must be above refill mark.
 - c. **Coolant level**. Inspect reservoir sight glass, if equipped. If not equipped, remove radiator cap and check for visible coolant level.
 - d. **Power steering fluid**. Indicate where power steering fluid dipstick is located. Check for adequate power steering fluid level. Level must be above refill mark.
 - e. **Engine compartment belts**. Check the following belts for snugness (up to $\frac{3}{4}$ inch play at center of belt), cracks, or frays:
 - ✓ Power steering belt
 - ✓ Water pump belt
 - ✓ Alternator belt

- ✓ Air compressor belt

NOTE: If any of the components listed above are not belt driven, you must tell the examiner which components are not belt driven and make sure that the component(s) are operating properly, are not damaged or leaking, and are mounted securely.

- i. **Hydraulic brakes master cylinder & brake fluid.** Checks that mater cylinder is securely attached and not leaking. Checks the level of brake fluid in the reservoir to ensure it is between the add and full marks.
- j. **Safe start.** Depress clutch. Place gearshift lever in neutral or park, for automatic transmission.
- k. **Windshield fluid level,** connections, and tie downs (battery may be located elsewhere).
- l. Automatic transmission fluid level.
[Nevada Commercial Driver License Manual](#), (pg.11-1)

Cab Check/Engine Start

- 1. **Oil pressure gauge.** Make sure oil pressure gauge is working. Check that pressure gauge shows increasing or normal oil pressure or that the warning light goes off. If equipped, oil temperature gauge should begin a gradual rise to the normal operating range.



- 2. **Temperature gauge.** Make sure temperature gauge is working. Temperature should begin to climb to the normal operating range or temperature light should be off.

3. **Air gauge.** Make sure the air gauge is working properly. Build air pressure to governor cut-out, roughly 120-140 psi.
4. **Ammeter/voltmeter.** Check that gauges show alternator and/or generator is charging or that warning light is off.
5. **Mirrors and windshield.** Mirrors should be clean and adjusted properly from the inside. Windshield should be clean with no illegal stickers, no obstructions, or damage to the glass.
6. **Emergency equipment.** Check for spare electrical fuses.

Note: If vehicle is not equipped with electrical fuses, you must mention this to the examiner.

- a. Check for three red reflective triangles.
 - b. Check for a properly charged and rated fire extinguisher.
7. **Wipers/washers** (OOS). Check that wiper arms and blades are secure, not damaged and operate smoothly. If equipped, windshield washers must operate correctly.
 8. **Lights/reflectors/reflector tape condition** (OOS). Test that dash indicators work when corresponding lights are turned on:
 - a. Left turn signal;
 - b. Right turn signal;
 - c. Four-way emergency flashers;
 - d. High beam headlight; and
 - e. Anti-lock Braking System (ABS) indicator
 9. Check that all **external lights** and **reflective equipment** are clean and functional, including:
 - a. Clearance lights (red on rear, amber elsewhere);
 - b. Headlights (high and low beams);

- c. Taillights;
- d. Backing lights;
- e. Turn signals;
- f. Four-way flashers;
- g. Brake lights;
- h. Red reflectors (on rear) and amber reflectors (elsewhere); and
- i. Reflector tape condition.

Note: Checks for brake, turn signal and four-way flasher functions must be done separately.

10. **Horn** (OOS). Check that horn works.
11. **Heater/defroster** (OOS). Test that the heater and defroster work.
12. **Parking brake check** (OOS). With the parking brake engaged; check that the parking brake will hold the vehicle by gently trying to pull forward with parking brake on.
13. **Hydraulic brake check** (OOS). Pump the brake pedal three times, and then hold it down for five seconds. The brake pedal should not move (depress) during the five seconds.

If equipped with a hydraulic brake reserve (back-up) system, with the key off, depress the brake pedal and listen for the sound of the reserve system electric motor. Check that the warning buzzer or lights is off.

14. **Air brake check** (OOS). Failure to perform all three components of the air brake check correctly will result in an automatic failure of the vehicle inspection test. Air brake safety devices vary. However, this procedure is designed to see that any safety device operates correctly as air pressure drops from normal to a low air condition.

For safety purposes, in areas where an incline is present, you

will use wheel chocks during the air brake test.

The proper procedures for inspecting the air brake system are as follows:

- a. With the air pressure built up to governor cutoff (120 – 140 psi), shut off the engine, chock your wheels if necessary, release the parking brake, and fully apply the foot Brake.
- b. Hold the foot brake for one minute. Check the air gauge to see if the air pressure drops no more than three (3) pounds in one minute.
- c. Without re-starting the engine, turn electrical power to the “on” or “battery charge” position. Begin fanning off the air pressure by applying and releasing the foot brake. Low air warning devices (buzzer, light, and flag) should activate before air pressure drops below 60 psi or level specified by the manufacturer.
- d. Continue to fan off the air pressure. At approximately 40 psi the parking brake valve should close (pop out).

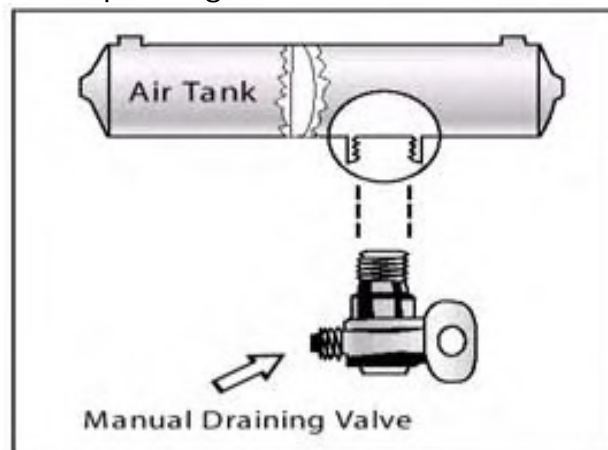

Typical School Bus Air System Schematic with a Bendix® AD-IS® Air Dryer

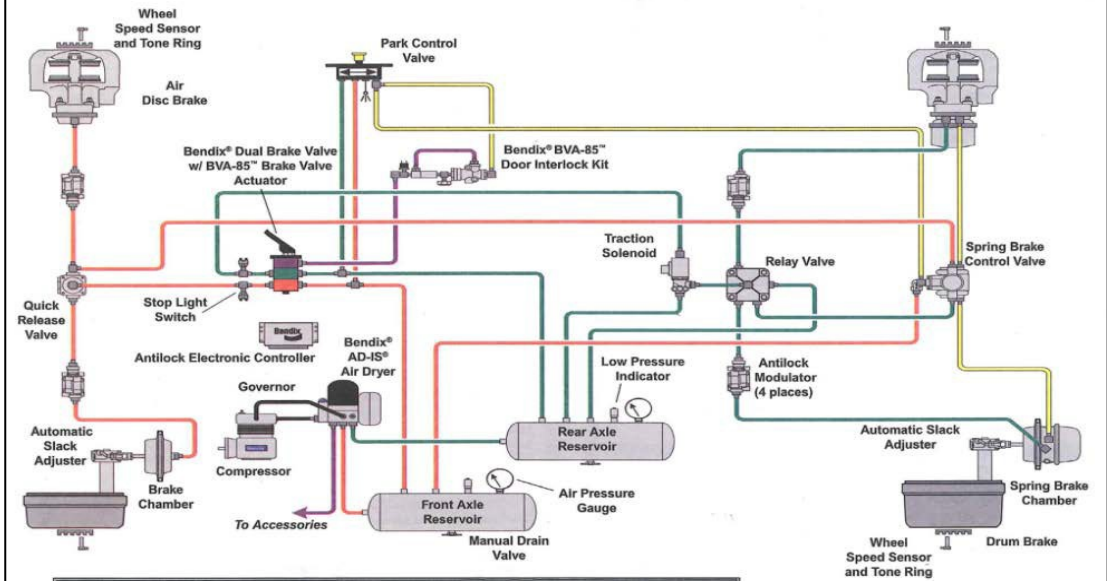

Typical School Bus Air System Schematic with a Bendix® AD-9® Air Dryer

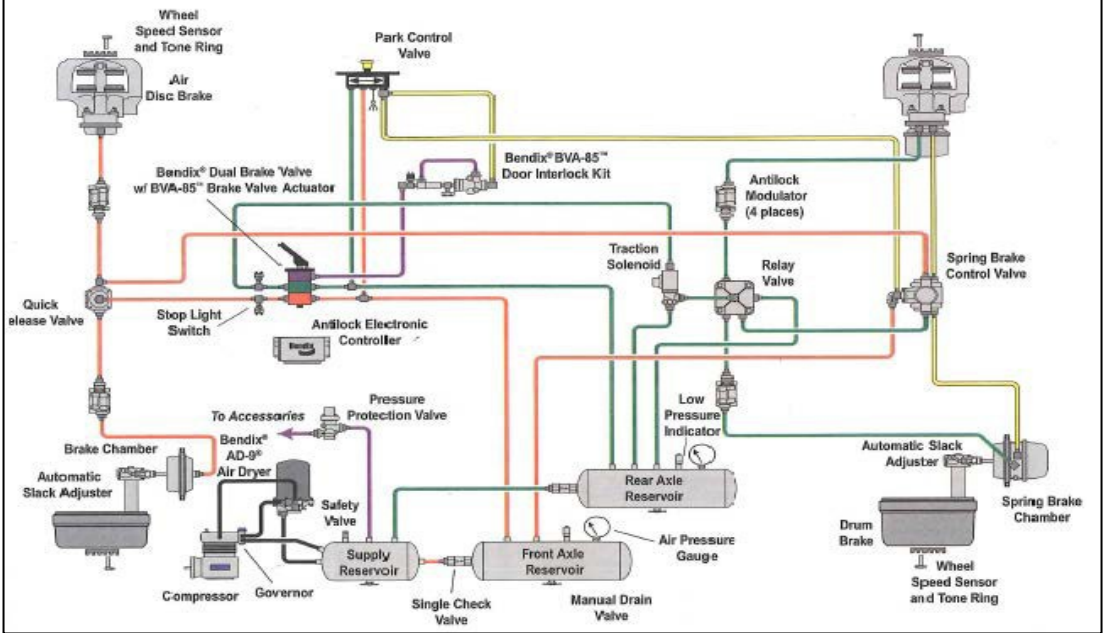

15. **Service brake** (OOS). You are required to check the application of air or hydraulic service brakes. This procedure is designed to determine that the brakes are working correctly

and that the vehicle does not pull to one side or the other.

Pull forward at 5 mph, apply the service brake and stop. Check to see that the vehicle does not pull to either side and that it stops when brake is applied.

16. **Safety belt** (OOS). Check that the safety belt is securely mounted, adjusts, latches properly and is not ripped or frayed. [Nevada Commercial Driver License Manual](#), (pg. 11-2)

EXTERNAL INSPECTION

1. Walk around and do a general inspection of the bus.
2. **Steering box/hoses**. Check that the steering box is securely mounted and not leaking. Look for missing nuts, bolts, and cotter keys.
3. Check for **power steering fluid** leaks or damage to power steering hoses.
4. **Steering linkage**. See that connecting links, arms, and rods from steering box to the wheel are not worn or cracked.
5. Check that joints and sockets are not worn or loose and that there are no missing nuts, bolts, or cotter keys.

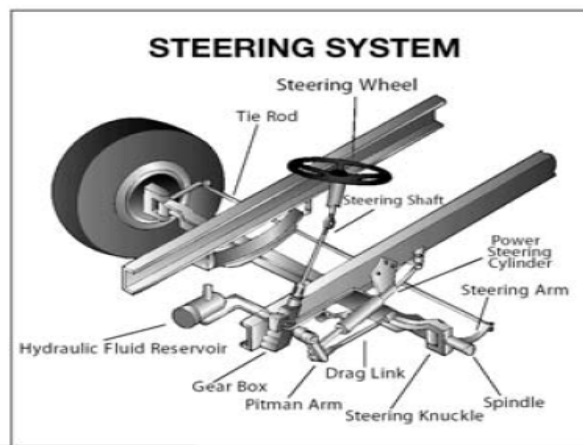

6. **Suspension** (OOS)
 - a. **Springs/air/torque**. Look for missing, shifted, cracked or broken leaf springs:

- ✓ Look for broken or distorted coil springs.
- ✓ If vehicle is equipped with torsion bars, torque arms, or other types of suspension components, check that they are not damaged and are mounted securely.
- ✓ Air ride suspensions should be checked for damage and leaks.

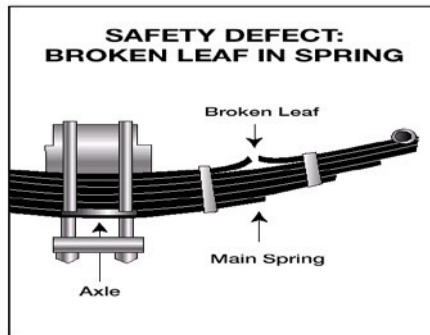

- b. **Mounts.** Look for cracked or broken spring hangers, missing or damaged bushings, and broken, loose, or missing bolts, U-bolts or other axle mounting parts. (The mounts should be checked at each point where they are secured to the vehicle frame and axle(s)).
- c. **Shock absorbers.** See that shock absorbers are secure and that there are no leaks. Be prepared to perform the same suspension components inspection on every axle.

7. Brakes (OOS)

- a. **Slack adjusters and pushrods.** Look for broken, loose, or missing parts. For manual slack adjusters, the brake pushrod should not move more than one inch (with the brakes released) when pulled by hand.
- b. **Brake chambers.** See that brake chambers are not leaking, cracked, or dented and are mounted securely.
- c. **Brake hoses/lines.** Look for cracked, worn, or leaking hoses, lines and couplings.
- d. **Drum brake/disc brakes.** Checks for cracks, dents, or holes. Also check for loose or missing bolts. Check for

contaminates such as debris or oil/grease.

- e. **Brake linings.** On some brake drums, there are openings where the brake linings can be seen from outside the drum. For this type of drum, check that a visible amount of brake lining is showing.

Note: Be prepared to perform the same brake components inspection on every axle.

[Nevada Commercial Driver License Manual](#), (pg. 11-3)

8. **Wheels (OOS)**

- a. **Rims.** Check for damaged or bent rims. Rims cannot have welding repairs.
- b. **Tires.** The following items must be inspected on every tire:
 - ✓ **Tread depth.** Check for minimum tread depth (4/32 on steering axle tires, 2/32 on all other tires).
 - ✓ **Tire condition.** Check that tread is evenly worn and look for cuts or other damage to tread or sidewalls. Also, make sure that valve caps and stems are not missing, broken, or damaged.
 - ✓ **Tire inflation.** Check for proper inflation by using a tire gauge. NOTE: You will not get credit for simply kicking the tires to check for proper inflation.
- c. **Hub oil seals/axle seals.** See that hub oil/grease seals and axle seals are not leaking and, if wheel has a sight glass, oil level is adequate.
- d. **Lug nuts.** Check that all lug nuts are present, free of cracks and distortions, and show no signs of looseness such as rust trails or shiny threads. Make sure all bolt holes are not cracked or distorted.
- e. **Spacers or budd spacing.** If equipped, check that

spacers are not bent, damaged, or rusted through. Note: Be prepared to perform the same wheel inspection on every axle.

[Nevada Commercial Driver License Manual](#), (pg. 11-4)

9. **Side of Vehicle** (OOS)

- a. **Door(s)/mirror(s)**. Check that doors are not damaged and that they open and close properly from the outside (includes emergency exits).
- b. **Hinges** should be secure and seals intact.
- c. Check that **mirrors** and **mirror brackets** are not damaged.
- d. **Fuel tank**. Check that tank is secure, cap is tight, and there are no leaks from tank or lines.
- e. **Driveshaft**. Driveshaft guard loose, missing, improper placement or bent. Universal joint(s) worn or faulty, or obvious welded repair. [National School Transportation Specifications and Procedures, 2015](#) (pg. 86)
- f. **Exhaust system**. Check system for damage and signs of leaks such as rust or carbon soot. System should be connected tightly and mounted securely.
 - ✓ If equipped with emissions after-treatment equipped, check DEF tank to ensure the level of diesel exhaust fluid in the tank is adequate (more than 1/8th tank).
- g. **Frame**. Look for cracks, broken welds, holes or other damage to the longitudinal frame members, cross members, box and floor.

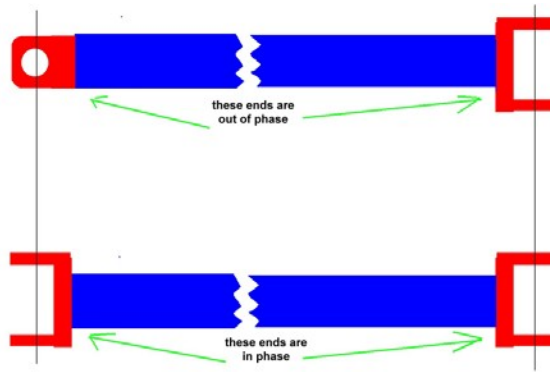

10. **Rear of vehicle (OOS)**

- a. **Splash guards.** If equipped, check that splash guards or mud flaps are not damaged and are mounted securely.
- b. **Doors/ties/lifts.** Check that doors and hinges are not damaged and that they open, close, and latch properly from the outside, if equipped.

SCHOOL BUS INSPECTION CRITERIA

In addition to the requirements for inspecting all CMV's, school buses have equipment specific to the vehicle. These are the additional inspection criteria you need to know.

1. **Emergency equipment (OOS).** The following emergency equipment must be inspected.
 - a. **Fire extinguisher.** The bus shall be equipped with at least one UL-approved pressurized, dry chemical fire extinguisher. The extinguisher shall be secured in a mounted bracket, located in the driver's compartment and readily accessible to the driver and passengers. A pressure gauge shall be mounted on the extinguisher and shall be easily read without moving the extinguishers from its mounted position.

The first extinguisher shall have a rating of 2-A: 10-BC, or greater. The operating mechanism shall be secured with a type of seal that will not interfere with the use of the fire extinguisher.

[National School Transportation Specifications and Procedures, 2015](#), (pg. 38)

- b. **First aid and body fluid clean-up kits.** The bus shall have a removable, moisture-proof and dust-proof first aid and body fluid clean-up kits in an accessible location.

The kit can be mounted or stored in a compartment. If mounted, it must be clearly labeled. If stored in a compartment, the compartment must be clearly labeled, easily accessible to the driver and not blocked.

- c. **Emergency warning devices.** Must be equipped with at least three reflectorized triangles that are stored in a secure location. [Federal Motor Carrier Safety Regulation 392.22, Emergency Signals: Stopped Commercial Motor Vehicles](#)

- 2. **Lighting indicators** (OOS). In addition to checking the lighting indicators listed above in Lights/Reflectors/Reflector Tape, school bus drivers must also check the following lighting indicators:
 - a. Alternately flashing amber lights indicator;
 - b. Alternately flashing red lights; and
 - c. Strobe light indicator (if equipped).
- 3. **Lights/reflectors** (OOS). In addition to checking the lights and reflective devices listed above in Lights/Reflectors/Reflector Tape, school bus drivers must also check the following external lights and reflectors:
 - a. Strobe light (if equipped);
 - b. Stop arm light;
 - c. Alternately flashing amber lights; and
 - d. Alternately flashing red lights.
- 4. **Mirrors** (OOS). Check that all mirrors (inside student rear view mirror, crossover mirrors, flat mirrors and convex mirrors):
 - a. Are properly adjusted;
 - b. Are not missing, damaged, clouded or obscured;

- c. Are mounted securely with no loose fittings;
 - d. Visibility is not impaired due to being dirty; and
 - e. Holds a set when adjusted.
5. **Stop arm** (OOS). If equipped, check the stop arm to see it is mounted securely to the frame of the vehicle. Also, check for loose fittings and damage.
 6. **Passenger entry/lift** (OOS). Check that the entry door is not damaged, operates smoothly, and closes securely from the inside.
 7. **Hand rails** are secure and the step light is working.
 8. **Entry step** must be clear with the treads not lose or worn excessively.
 9. If equipped with a **handicap lift**, look for leaking, damaged, or missing parts and explain how lift should be checked for correct operation. Lift must be fully retracted and latched securely.
 10. **Emergency exits** (OOS). Make sure that all emergency exits are not damaged, operate smoothly, and close securely from the inside. Emergency Exit doors must be operational from inside and outside the school bus. Check that emergency exit warning devices are working.
 11. **Seating** (OOS). Look for broken seat frames and check that seat frames are firmly attached to the floor. Check that seat cushions are attached securely to the seat frames.
- [Nevada Commercial Driver License Manual](#), (pg. 11-6)

WHEELCHAIR LIFT EQUIPPED BUSES (OOS)



1. Wheelchair lift does not function as designed or is inoperable.
2. Platform lift manufactured after April 1, 2005 that does not meet all the following criteria (as referenced in [Federal Motor Vehicle Safety Standard 571.403, Platform Lift Systems for Motor Vehicles](#) and [Federal Motor Vehicle Safety Standard 571.404, Platform Lift Installation in Motor Vehicles](#).
 - a. Jacking prevention;
 - b. Manual backup operating mode;
 - c. Interlocks to prevent forward or rearward mobility of the vehicle unless lift is stowed and doors are closed;
 - d. Wheelchair retention device; and
 - e. Platform outer barrier and inner roll stop.
3. Any hydraulic line leaking during lift operation.
4. Wheelchair restraint system that is missing, incomplete or improperly installed, loose or damaged. [National School Transportation Specifications & Procedures, 2015](#), (pg. 97)
5. Each wheelchair position has 4 securement straps. A lap belt, and a shoulder belt.
6. Wheelchair restraint systems are properly stored when not secured to the bus.
7. There is at least one belt cutter and emergency evacuation blanket.
8. Retractors are working by pulling out the webbing to ensure they are locking properly.
9. Webbing is not cut, frayed, damaged or contaminated.
10. Metal parts are not worn, broken or cracked.
11. Pin connector bushings are not cracked, broken or missing.
12. Mounting hardware, such as bolts, nuts, etc. are secure.

13. Floor anchorages are clean and secured.
14. Buckles are not damaged and operate properly.

AFTER-TRIP VEHICLE INSPECTION

You are required to inspect your bus at the end of each shift. The report must specify each bus and list any defect that would affect safety or result in a breakdown. [Nevada Commercial Driver License Manual](#), (pg. 2-1)

POST-TRIP INSPECTION REQUIREMENTS

When your route or school activity trip is finished, you should conduct a post-trip inspection of the bus. You should walk through the bus and around the bus looking for the following.

1. Articles left on the bus
2. Sleeping students
3. Open windows and doors
4. Mechanical/operational problems with the bus, with special attention to items that are unique to school buses-mirror systems, flashing warning lamps and stop signal arms
5. Damage or vandalism
6. Any problems or special situations should be reported immediately to your supervisor or school authorities.
[Nevada Commercial Driver License Manual](#), (pg. 10-6)

SECURITY INSPECTION-ANYTIME THE BUS IS LEFT UNATTENDED

Any time you leave your bus unattended for any length of time, you need to do a security inspection of your school bus and check the following areas for suspicious packages, devices, substances, or baggage.

1. Floors;

2. Below seats;
3. Driver's area;
4. Steps;
5. Wheelchair lifts (if equipped);
6. Lights;
7. Wheel wells;
8. Engine compartments;
9. Exhaust system;
10. Fuel and air tanks;
11. Emergency exit doors; and
12. Storage compartments.

**After each trip, make sure to walk the school bus and check for students!
Don't be the person who left a child on a school bus! Check after each trip!**

INSPECTION CRITERIA DESCRIPTIONS

Accelerator/brake pedal. Accelerator pedal is on the right and makes the vehicle go. Brake pedal is on the left and stops the vehicle. Check that it is connected and functional.

Air brakes. Uses compressed air to make the brakes work. With the engine running, build the air pressure to 120-140 psi. Shut the engine off and push in the parking brake, press on the foot brake and hold it for 1 minute. Check the air gauge to see if the air pressure drops not more than 3 psi in 1 minute. With the key in the on position, begin applying and releasing the foot brake. The low air warning device should activate before the air pressure drops below 60 psi. Continue to apply and release the foot brake, at approximately 40 psi, the parking brake should pop out.

Air compressor belt/gear. With the engine off, driver points to air compressor. Mention that the compressor is securely mounted and not leaking. Identifies the belt that drives air compressor. With engine off, driver points to, touches, or presses the belt to test that it is snug. Notes that the belt is not frayed, has no visible cracks, loose fibers, or signs of wear. Pushes belt with hand, and if it deflects more than $\frac{1}{2}$ to $\frac{3}{4}$ of an inch, driver observes that slippage is probably excessive.

Air gauge. Check that the air gauge is working properly and that the air compressor builds the air pressure to governor cut-out at roughly 120-140 psi.

Air leaks/level. Air brake and suspension systems. Be sure that the vehicle is sitting level (front and rear), and if air-equipped, check for audible air leaks from air brake system or suspension system air bags.

Alternator belt/gear. With engine off, points to or touches alternator. Mentions the alternator is securely mounted and that all wires are securely fastened. Identifies belt that drives alternator or generator. With engine off, points to, touches, or presses belt to see that the belt is snug. Notes that the belt is not frayed, has no visible cracks, loose fibers, or signs of wear. Pushes belt with hand and if it deflects more than $\frac{1}{2}$ to $\frac{3}{4}$ of an inch, driver observes that slippage is probably excessive.

Ammeter/voltmeter. Indicate if alternator is properly functioning. Driver checks that the gauge shows that the alternator or generator is charging, and the warning light is off. Needle will jump and flutter, then indicate charged. Voltmeter needs to be within normal operating range which is 12-14 volts and the ammeter should be above zero.

Anti-lock brake systems (ABS). Prevents brakes from locking up. When starting your engine ABS light should go on and off, you should hear "popping noises" this is an automatic checking system on each tire. If you do not hear any popping noises, the ABS could be defective. If the ABS is defective, braking will default back to the regular braking system.

Axle seals. Make sure there are no cracks or distortions in wheel/axle mounting and there are no signs of leaking lubricants. If the axle has a sight glass, driver checks that oil level is adequate.

Battery box. Wherever located, see that the batteries are secure, connections are tight, and cell caps are present. Battery connections should not show signs of excessive corrosion. Battery box and cover or door must be secure.

Brake chambers. See that brake chambers are not leaking, cracked, or dented and are mounted securely. All mounting hardware is present and secure.

Brake drum/linings. Brake shoes and linings rub on the inside of the drum to slow the vehicle down. Check for cracks, dents or holes. Also check for loose or missing bolts. Brake linings (where visible) are no thinner than ¼ inch. Check brake drum and linings for contaminants such as grease, oil, etc.

Brake Hoses/Lines. Check that the hoses/lines can supply air or hydraulic fluid to brakes. Check for cracked, worn or frayed hoses, and that all couplings are secure and not leaking.

Clutch/gearshift. Disengages engine from drive train so vehicle won't move and reduces load on starting motor. Depress clutch before turning on the starter. Keep it depressed until the engine reaches idling speed. On an automatic transmission, place the gear selector in the park or neutral position. On a standard transmission, place gearshift in neutral. Start engine and release the clutch slowly.

Coolant level. Look at sight glass of reservoir, or if the engine is not hot, remove the radiator cap and look to see the level. Adequate level will show in sight glass or be visible in the radiator when the cap is removed. Note: If the engine is hot, **do not remove** the radiator cap.

Crossing control arm. Check to make sure that it activates with red loading lights and retracts back to bumper fully. Driver may not, at any time, tie the crossing arm to the bus preventing it from extending out. The crossing arm must always be operational, or bus is Out-of-Service, except for special needs buses which are used solely to transport special needs students who are manually loaded and unloaded.

Doors/hinges. Check that driver and passenger entry, exit, rear and side doors are not damaged and that they open, close and latch properly from the inside. Check door window for damage and excessive dirt. Hinges should be secure with seals intact. Check that all emergency exits are clearly labeled and working correctly.

Driveshaft. Visually and physically inspect each segment of the driveshaft and association hardware. Inspect for bends, cracks, missing weights or debris entangled in the shaft. Each shaft more than 18 inches long shall be equipped with a suitable guard to prevent an accident or injury in the event of its fracture of disconnection, bent or missing.

Visually and physically inspect each universal joint and center bearing. The universal joint(s) and center bearing(s) shall not be loose or worn and shall have all attaching hardware securely fastened. Check for lateral and vertical movement of the universal joints and center bearing by grasping the universal joint and attempting to move it. Check for welded repairs. [National Transportation Specifications and Procedures, 2015](#) (pg. 108)

Driver's seat/seat belt. Must be secured to floor and driver seat belt is not frayed, securely mounted, adjusts and latches properly.

Emergency equipment. Check for three red reflective triangles, fire extinguisher, first-aid kit, body-fluid clean up kit and spare fuses (if used). All emergency equipment must be readily accessible to the driver and clearly labeled.

Emergency exits. Make sure that the bus is equipped with the required number of emergency exits, emergency exits are not damaged, operate smoothly, and open and close securely from the inside and outside of the school bus. Check that all emergency exit-warning devices are working and are properly identified. Check that the flip seat at any emergency exit can remain in the upright position when not in use has no obstructions and the safety mechanism is operational. Student restraint systems cannot be placed next to an emergency exit.

Exhaust system. Check system for damage and signs of leaks such as rust or carbon soot. System should be connected tightly and mounted securely.

Fire extinguisher. Fire extinguisher must be fully charged, properly rated, sealed, pin in place and a current certification tag. The fire extinguisher must be secured and readily accessible to the driver.

Frame. Check that there are no cracks and frame members are not bent. No loose, cracked, bent, broken or missing cross members. Cracks are most likely to appear midway between points of attachment to vehicle assemblies. Check that floors are not damaged.

Fuel tank. Check that tank(s) are securely mounted with mounting straps, caps are tight and there are no leaks from tank(s) or lines. Signs of spillage from overfilling a fuel tank are not to be treated as a fuel leak. Fuel tank guard, if equipped, is securely mounted.

Glow plug/indicator light. The key should be turned to the “on” position and the driver should wait until the glow plug indicator goes out before starting the engine.

Heater/defroster. Test that heater and defroster work.

Horn. Check that horn works.

Hub oil seal. Checks that wheel hub oil seal on the front axle is not leaking. If a sight glass is present, visibly check that oil level is adequate.

Hydraulic brakes. On buses without airbrakes, pump brake pedal 3 times and hold down for 5 seconds. Brake pedal should not move (depress) during this time. If equipped with a hydraulic brake reserve (back-up system), with the key off, press the brake pedal and listen for the sound of the reserve system electric motor. Check that the warning buzzer or light is off.

Leaks/hoses. Look for puddles or dripping fluids on the ground, under the engine or the underside of the engine and transmission. Inspect engine hoses for condition and leaks.

Lighting indicators. Check dash indicators to make sure both left- and right-hand turn signals, 4-way flashers, headlight high beams, and fog/driving lights illuminate when corresponding lights are turned on.

Lights/reflectors. Check that all outside lights and reflective equipment is clean and functional and lenses are not cracked, broken or missing. This includes clearance lights (red on rear and amber elsewhere), headlights (both high and low beams), tail lights, turn signals, four-way flashers, brake lights, red reflectors (on rear) and amber reflectors (elsewhere), strobe light (if equipped), stop arm light and alternately flashing amber and red lights. You must check the brake, turn signal and four-way flashers functions operate separately.

Lug nuts. Check that all lug nuts are present, are not loose (look for rust trails around nuts), have no cracks radiating from lug bolt holes, or distortion of the bolt holes.

Mirrors (All). Inspect side mirrors and passenger entry/exit mirrors. Check for proper adjustment during in-cab inspection. Check that all internal and external mirrors and mirror brackets are not damaged cracked, broken and are mounted securely with no loose fittings. Check to assure that visibility is not impaired due to dirty mirrors.

Oil level. Check oil level before starting the engine. Be able to indicate where dipstick is located. Check that oil level is above the refill mark and in a safe operating range.

Oil pressure gauge. Check that the oil pressure is building to normal. The gauge shows increasing/decreasing oil pressure or warning light goes off. Engine oil temperature gauge (if present) should begin a gradual rise to normal operating range.

Parking/maxi brake. Check that the parking brake will hold the vehicle by gently trying to pull forward with the parking brake on.

Passenger entry. Check that the entry door is not damaged, operates smoothly, and closes securely. Check that handrails are secure, and the step light is working. Check that entry steps are clear with the treads not loose or worn excessively.

Passenger seats. Check that there is no broken seat frames and that the frames are firmly attached to floor. Seat cushions must be attached securely to the seat frame and cannot be damaged.

Power steering fluid. With the engine stopped, check the dipstick and see where the fluid level is. Level must be above refill mark.

Power steering pump (belt or gear). With the engine off, driver must point to, touch, or press belt to test that it is snug. Note that the belt is not frayed, has no visible cracks, loose fibers or signs of wear. Push belt with hand, and if it deflects more than 1/2 to 3/4 of an inch, slippage is probably excessive. Need to know and mention if pump is belt driven or gear driven. If device is gear driven, must be able to know of the belt/gear is operating properly, is not damaged or leaking and is properly mounted and secure.

Rims. Tires are mounted on rims or bare metal. Check for damaged or bent rims. Rims cannot have any non-manufactured welds. Check for rust trails that may indicate rim is loose on hub.

Shock absorbers. Check that shock absorbers are secure and that there are no leaks. Be prepared to inspect the same suspension components on every axle.

Slack adjuster. Check for broken, loose, or missing parts. With brakes released, when pulled by hand push rod should not move more than

approximately 1 inch. Check that mounting hardware is present and not damaged or missing.

Spacers. If equipped, check that spacers are not bent, damaged or rusted through. Check that spacers are evenly centered, with the dual wheels and tires evenly separated. Note: If vehicle is not equipped with spacers, driver must mention this and check between the discs (Budd) wheels for even spacing, damage and foreign objects.

Splash guards. Check that splashguards or mud flaps are not damaged and are mounted securely.

Spring/air/torque. Look for missing, shifted, cracked or broken leaf springs. Look for broken or distorted coil springs. If vehicle is equipped with torsion bars, torque arms or other types of suspension components, check that they are not damaged and are mounted securely. Check air ride suspension for damage and leaks.

Spring mount. Check that spring attachments (brackets, bolts, bushings) are in place. Check for cracked or broken spring hangers. Check for broken, missing or loose bolts (including U-bolts). Check for missing or damaged bushings. Check for broken, lose or missing axle mounting parts.

Steering box/hoses. Check that the steering box is securely mounted and not leaking. Look for any missing nuts, bolts and cotter pins. Check for power steering fluid leaks or damage to power steering hoses.

Steering linkage. Check that connecting drag link, pitman arm, tie rod and upper and lower steer arms from the steering box to the wheel are not worn or cracked. Check that joints and socket are not worn or loose. Check for loose or missing nuts, bolts or cotter pins.

Steering play. Turn steering wheel back and forth and see that there should not be more than 10 degrees (approximately 2 inches movement at the rim of a 20-inch steering wheel).

Stop arms. Check the stop arm to see that it is mounted securely to the frame of the vehicle. Check for loose fittings and damage. Check that the stop arm extends fully when operated and stop arm lights are operational.

Temperature gauge. Measures coolant temperature in the engine cooling system. Make sure the temperature gauge is working. Temperature should begin to climb to the normal operating range or temperature light should be off.

Tires. Check every tire for the following.

1. No recaps on the front tires.
2. Bias and radial tires have not been combined.
3. Check minimum tread depth (4/32" on steering axle tires, 2/32" on all other tires).
4. Check tire condition. Tread is evenly worn and look for cuts or other damage to tread or sidewalls. Also, make sure that valve caps and stem are not missing, broken, or damaged.
5. Check for proper inflation.

[Nevada Commercial Driver License Manual](#) (pg. 11-4)

Water pump/belt. With the engine off, point to, touch or press the belt to test that it is snug. Note that the belt is not frayed, has no visible cracks, loose fibers, or signs of wear. Push the belt with hand, and if it deflects more than 3/4 of an inch, slippage is likely and belt needs tightened. Drivers should know and mention if pump is belt driven or gear driven. Water pump appears to be functioning, properly mounted and secure and not leaking.

Wheelchair lift/tie downs. Check for leaking, damaged or missing parts and explain how it should be checked for correct operation. Check that doors and hinges are not damaged and that they open, close, and latch properly. Check that wheelchair ties are secure. Wheelchair lift must be fully retracted and latched securely.

Windshield. Check the windshield to make sure it is clear, clean and has no illegal stickers, obstructions or damage to the glass. Windshield cannot obstruct the drivers view.

Wipers/washers. Check that wiper arms and blades are secure, not damaged and operates smoothly. Check for windshield washer fluid and that windshield washers operate correctly.

SECTION 3: BASIC DRIVING LAWS

SIGNS

Signs regulate, warn and inform. The shapes and colors of highway signs have special meanings. This helps you understand the message quickly.

Standard Colors

RED – stop

GREEN – go, direction or guidance

YELLOW or **YELLOW GREEN** – general warning – regulatory, law or rule

ORANGE – road construction or repair warning

BLUE – driver services, such as food and lodging

BROWN – recreation and scenic area information

Standard Shapes

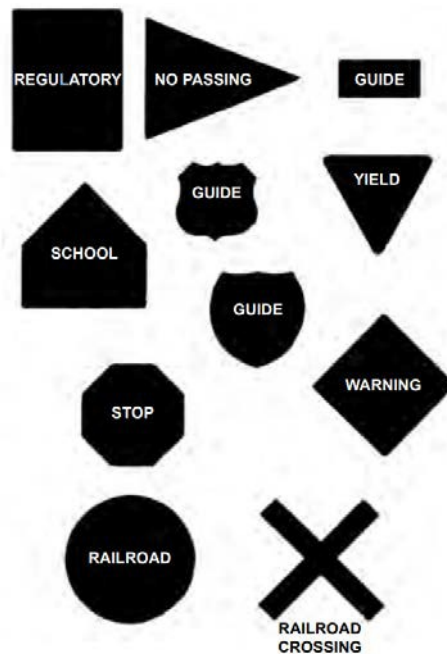

Standard Signs

1. **Stop signs.** You must come to a full stop behind the stop sign at the crosswalk or stop line. If your view of the cross street is blocked, slowly move forward to determine when it is safe to

proceed.

- a. If no stop signs or markings exist, you must slow down and stop, if necessary, at the point nearest the intersection where you have a view of approaching traffic on the through highway.
- b. You must give right-of-way to pedestrians, bicyclists and any cross traffic before moving.



2. **Yield signs.** Mean the same as stop signs except you may proceed without coming to a full stop, if it is safe to do so. You must:

- a. Slow down as you come to the intersection; and
- b. Give the right of way to pedestrians and through.



3. **Regulatory signs.** Are rectangular and have a white background. They inform you of traffic laws and regulations. You must obey these signs.



4. **Warning signs.** Are yellow, diamond-shaped sign with black letters and symbols. They tell you there are special conditions or hazards ahead.



5. **Railroad crossing signs.** Warns you that you need to slow down and have to stop for a train. The cross buck (X) marks the actual location of the train tracks. School buses have specific requirements for railroad crossings.



6. **Route signs and markers.** Are usually shaped like a shield, but there are different shapes and colors. These signs show U.S., Interstate and State Route Numbers.



Construction and Maintenance Signs

Are used to notify drivers of possible danger in or near work areas. Most signs used in highway and street work areas are diamond-shaped.

Cones, drums and barricades are used to alert you and to guide you safely through work areas. For night work, they may be equipped with warning lights. When used, you must slow down and follow the direction of the posted signs and any construction flaggers that may be present.

[Nevada Driver Handbook](#), (pg. 29)



Violations in construction, work and school zones result in higher fines

SIGNALS

Signals control traffic at intersections. Combinations of traffic and pedestrian signals, signs, pavement markings and other traffic control devices may be used in some situations.

1. **Red light** means **STOP**. You must come to a complete stop before you reach the intersection. Stop your bus behind the stop line or crosswalk. If there is not a stop line or crosswalk, stop before entering the intersection. Remain stopped until the light turns green. Where not prohibited by signs, a right turn may be made on a red light after coming to a complete stop, when motor and pedestrian traffic is clear and it is safe to proceed.
2. **Yellow light** means **CAUTION**. A steady yellow light is a warning that the light will be turning red. If you have not entered the intersection, you must stop. If you are already in the intersection, you should continue moving and clear it safely. **DO NOT** speed up to beat the light.
3. **Green light** means **GO**. You may proceed through an intersection in the direction indicated by the signal if the road is clear. Make sure you look right and left for oncoming traffic.
4. **Flashing red light** means that you must come to a **FULL STOP**. You may only go when you have the right-of-way.
5. **Flashing yellow light** means **PROCEED WITH CAUTION**.
6. **Red arrow** means you cannot make the movement shown by the arrow.
7. **Yellow arrow** means the signal is going to change to red and warns you to clear the intersection.
8. **Flashing yellow arrow** means **YIELD TO ONCOMING TRAFFIC and PEDESTRIANS**.
9. **Green arrow** means you may **GO IN THE DIRECTION SHOWN BY THE ARROW**, but you must yield to pedestrians, bicycles and traffic already in the intersection.
[Nevada Driver's Handbook](#), (pg. 30)

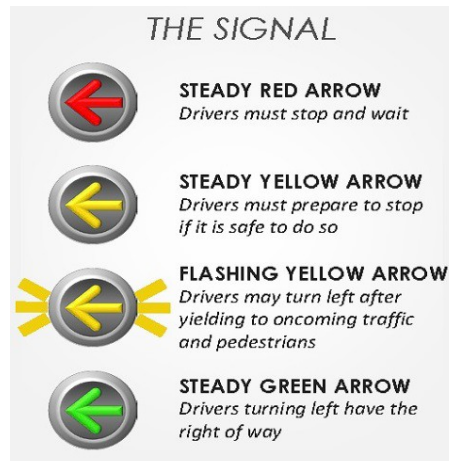

When a traffic control light is not working, you must come to a full stop, yielding to pedestrians, bicyclists and other vehicles that have stopped at the intersection, before proceeding through the intersection.

HIGHWAY MARKINGS

Highway markings like signs warn, regulate, and inform. Markings are white and yellow, and each type of line has a special meaning.

1. White Lines

- a. Dashed white lines are used to mark traffic lanes on roads which have more than one lane moving in the same direction. You should drive within these lanes and not straddle the lines. Passing is permitted when it is safe to do so (See (A) below).
- b. Solid white lines separate lanes of traffic moving in the same direction and mean that you do not change lanes or pass.

2. Yellow Lines

- a. Solid or dashed yellow lines mean you may pass when it is safe to do so (See (B) below).

- b. Solid or double yellow lines means you cannot pass or cross over the line (See (C) below).

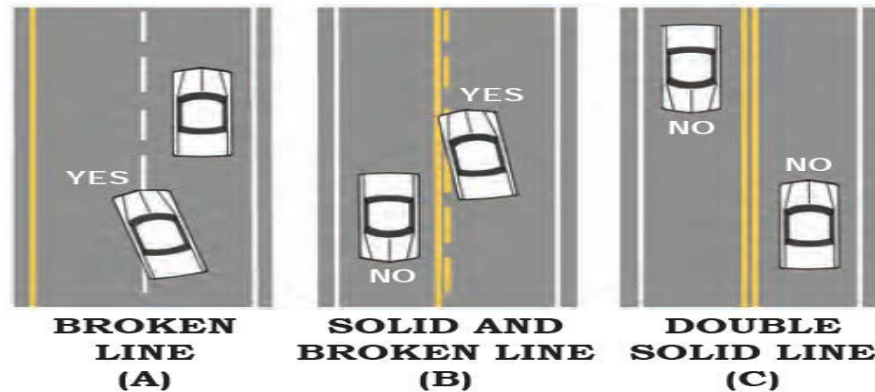

3. **Crosswalk Lines** are marked by solid white lines or various patterns. Always stop your vehicle before the crosswalk. At some intersections, especially in small towns or in residential areas, crosswalks may not be marked. You still must yield to pedestrians in the intersection.
4. **Stop Lines** are the wide white lines painted across a traffic lane where you must stop before you enter the intersection.
5. **Dotted White Lines** may either indicate an extension of a lane line through an intersection, or may indicate exit-only lanes on a freeway.
6. **Center Lanes** are marked on each side by solid yellow and broken yellow lines. You may cross these lines only to make a left turn onto or from the highway.
[Nevada Driver Handbook](#), (pg. 30)

Center lanes are not travel lanes and cannot be used for passing. You may not travel more than 200 feet in a center turn lane before making a left-hand turn and you may not travel more than 50 feet in a center lane after making a left-hand turn onto the highway before merging with traffic. [Nevada Revised Statute 484B.223](#)

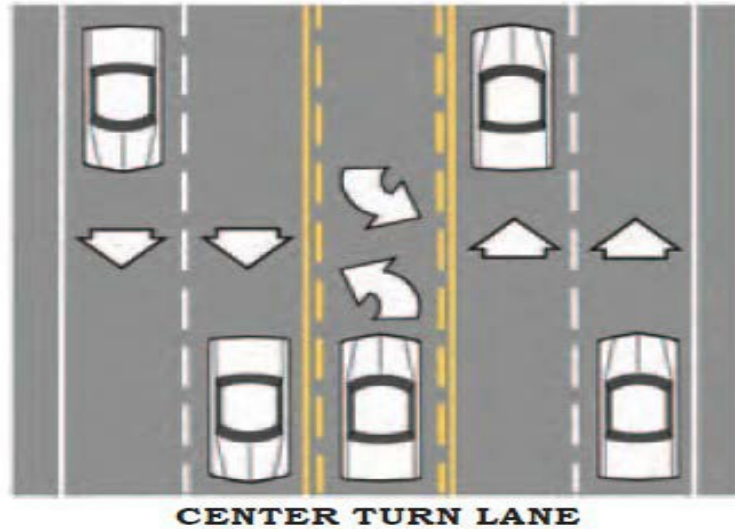

CONTROLLING SPEED

Nevada's **Basic Rule** for driving at a "reasonable or proper" speed means that in addition to any posted speed limits you must consider:

1. The amount and type of traffic;
2. The weather and the distance you can see;
3. The condition of the road surface such as dry, wet, icy or snow covered;
4. The type of road:
 - a. Whether it is flat and straight or steep and curvy; or
 - b. Whether it is wide or narrow.
5. It also means that you are never to drive at a speed that endangers you or anyone else. Depending upon conditions, the safe speed may be considerably less than the posted speed limit.
6. Most people speed to save time. Let's look at how much or how little time is actually saved to travel 5 miles.
 - a. At 70 mph takes 4 minutes, 17 seconds. Savings over 60 mph = 43 seconds.

- b. At 60 mph takes 5 minutes. Savings over 55 mph = 27 seconds.
 - c. At 55 mph takes 5 minutes, 27 seconds.
7. The next time you want to speed ask yourself:
- a. Why am I in a hurry?
 - b. Does it really matter?
 - c. Is it worth endangering myself and others? [Nevada Driver Handbook](#), (pg. 34)

If you are stopped for speeding and given a ticket, it will cost you time, money and possibly your job!

RIGHT-OF-WAY

Vehicle Right-of-Way Rules

1. When approaching an **intersection**, a driver shall yield the right-of-way to a vehicle which has entered the intersection.
2. When two vehicles **enter an intersection** from different highways at approximately the same time, the driver of the vehicle on the left shall yield the right-of-way.
3. When a vehicle enters an intersection controlled by a **traffic-control device that is inoperative**, the driver shall proceed as if a stop sign had been erected.
[Nevada Revised Statute 484B.250](#)
4. A driver of a vehicle within an intersection intending to make a **left hand turn** shall yield the right-of-way to any vehicle approaching from the opposite direction. [Nevada Revised Statute 484B.253](#)
5. The driver of a vehicle shall stop or yield at a **clearly marked stop line**, or if there is none, before entering the crosswalk on

the near side of the intersection, if there is none, then at the point nearest the intersection where the driver has a view of approaching traffic on the through highway. [Nevada Revised Statute 484B.257](#)

6. The driver of a vehicle about to **enter or cross a highway** from a private road shall yield the right-of-way to all vehicles approaching on the highway. [Nevada Revised Statute 484B.260](#)
7. A driver of a vehicle, upon the immediate approach of an authorized **emergency vehicle**, making use of flashing lights, shall yield the right-of-way and immediately drive to a position parallel to, and as close as possible to the right-hand edge or curb of a highway clear of any intersection and shall stop and remain in such position until the authorized emergency vehicle has passed.
8. If the emergency vehicle is moving in the same direction of travel, a driver shall not overtake the emergency vehicle. [Nevada Revised Statute 484B.267](#)

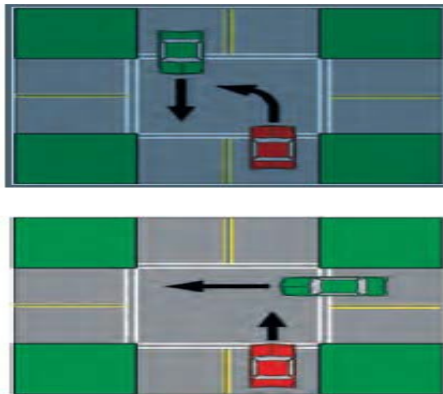

Bicycle Right-of-Way Rules

1. The driver of a vehicle shall not interfere with the movement of a **person riding a bicycle**. When overtaking or passing a bicycle, the driver shall exercise due care and:
 - a. Move to the lane to the immediate left, if the lane is available.
 - b. If there is only one lane of traffic, pass to the left of the bicycle at a safe distance, which must not be less than 3

feet between any portion of the vehicle and the bicycle.

2. The driver of a vehicle shall yield the right-of-way to any person riding a bicycle.
3. The driver of a vehicle shall not enter, stop, stand, park or drive within a pathway or lane provided for bicycles.
[Nevada Revised Statute 484B.270](#)

Pedestrian Right-of-Way Rules

In 2017 there were 100 pedestrian fatalities in Nevada! [Zero Fatalities Pedestrian Safety Facts](#)

A driver of a motor vehicle shall exercise due care to avoid a collision with a pedestrian.

1. Pedestrians facing a green light may cross the intersection unless a pedestrian signal or police officer directs otherwise. If a crosswalk is marked, pedestrians are to use the marked area.
2. Pedestrians facing a green turn arrow are not to cross unless a pedestrian signal or police officer allows them to do so.
3. Pedestrian walk and don't walk signals are special stop and go lights for pedestrians. If these signals are in place, pedestrians are to obey them. This may also be indicated by a lighted pedestrian figure or hand symbol in the signal:
 - a. Walk means pedestrians facing the signal may cross the street or highway in the direction of the signal.
 - b. Don't walk, if flashing, means the signal is changing. Pedestrians may not start across the roadway. However, if you are partly across when this begins flashing, you may continue to the sidewalk or safety island.
 - c. Don't walk, if constant, means pedestrians are not to cross.
 - d. Both drivers and pedestrians are responsible for safe use of

our roadways. Drivers should always be prepared to yield to pedestrians and bicyclists.

[Nevada Driver Handbook](#), (pg. 29)

4. You must yield the right-of-way to a pedestrian crossing in a marked or unmarked crosswalk when the pedestrian is upon the half of the highway upon which the vehicle is traveling, or when the pedestrian is approaching so closely from the opposite half of the highway as to be in danger. [Nevada Revised Statue 484B.283](#)
5. A person who is blind and who is on foot and using a service animal or carrying a cane or walking stick white in color, or white tipped with red, has the right-of-way when entering or when on a highway, street or road. When approaching such a person, a driver shall yield the right-of-way, come to a full stop and take precautions before proceeding to avoid a crash or injury of the person. [Nevada Revised Statue 484B.290](#)



FREEWAY DRIVING

Entering a Freeway

1. Be sure to use the on-ramp when you enter the freeway. Signs will say "Do Not Enter" and "Wrong Way" if you have made a mistake.
2. Using the merge or acceleration lane, look for an opening in traffic, use your turn signal and accelerate to the speed of freeway traffic. Do not stop before merging unless absolutely necessary; a stop can mean a slow and dangerous start into fast-moving traffic and can affect traffic behind you.

3. As you enter from a merging lane, you must yield to traffic already on the freeway. If you are already traveling on the freeway, watch for merging traffic and adjust your speed to allow safe and smooth merges.
4. Stay alert! Be prepared for rapid changes in road conditions and traffic flow. Search farther down the road – at least 20 to 30 seconds.
5. Watch traffic all around you. Be aware of other drivers who are changing lanes, passing or slowing down.
6. Use your mirrors, doing a 5-count mirror check and look quickly over your shoulder before changing lanes. Use your turn signals to let other drivers know your plans and watch for their signals. [Nevada Driver Handbook](#), (pg. 36)
7. Stay with the flow of traffic without exceeding the maximum speed.
8. Freeways have several lanes in each direction. On these roads, you should leave the extreme left lane for faster traffic.
9. School buses **ARE NOT ALLOWED** to travel in HOV or express lanes.

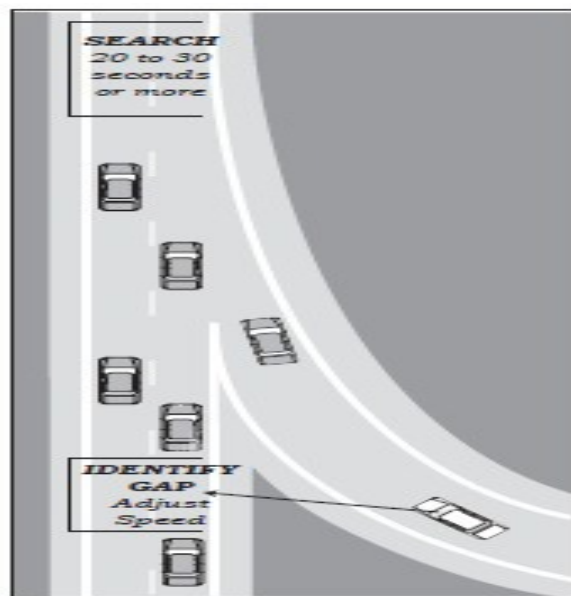

Exiting a Freeway

1. Most freeway exits have a special lane for you to use before you reach the exit ramp. Avoid slowing down on the freeway itself.
2. Wait until you are in the exit lane. Then slow gradually until your speed matches the posted exit ramp speed.
3. Look ahead for signs telling you about the exit you want and the lane you need to use.
4. Do a 5-count mirror check, signal and move into the proper lane a mile or more before the exit. Most exits are numbered to help you quickly spot the one you want to take.
5. If you miss the exit ramp, never turn around or back up. Go to the next exit, get back on the freeway in the opposite direction, and return to the exit you want.
[Nevada Driver Handbook](#), (pg. 35)

RAMP METERS, HIGH OCCUPANCY VEHICLE (HOV) LANES AND ROUNDABOUTS

Ramp Meters

1. If a freeway entrance is equipped with ramp meters and they are turned on, you must:
 - a. Pull up to the stop line and stop on red;
 - b. Be alert because the signal will change faster than a signal at an intersection; and
 - c. Wait for the green light. Then proceed along the ramp and merge onto the freeway safely.
2. Some freeway entrance ramps have more than one travel lane and each lane is controlled by its own ramp meter. School buses should be in the farthest right lane.
3. Some metered freeway ramps have HOV bypass lanes also known as carpool lanes. These lanes are marked with a diamond on the pavement and are not metered. School buses may enter

the freeway in these HOV lanes.
[Nevada Driver Handbook](#), (pg. 35)



High Occupancy Vehicle (HOV) Lanes

If there is an HOV bypass lane (also known as a carpool lane) while entering a freeway, marked with a diamond on the pavement, and the lane is not metered, school buses can use the HOV lane without stopping. [Nevada Driver Handbook](#), (pg. 37) and [Nevada Revised Statute 484A.460](#)

**School buses ARE NOT permitted to travel in
HOV, Carpool or Express Lanes!**

Roundabouts

1. A roundabout is a large circular area in the middle of an intersection meant to control the right-of-way of vehicles. It is a traffic management tool that moves traffic through an intersection without the aid of traffic signals.
2. When entering traffic, you must yield the right-of-way to the traffic circulating within the roundabout and decrease speed while traveling in one direction with traffic already in the roundabout.
3. When approaching a roundabout:
 - a. Choose which lane to use as you would for any other intersection.
 - b. Use the left lane to turn left, complete a U-turn or go straight.

- c. Use the right lane to turn right or go straight.
 - d. Yield to those in the roundabout who have the right-of-way. Wait for a gap in the traffic.
 - e. Decrease your speed to travel with the traffic already in the roundabout.
 - f. Use your right turn signal when exiting.
4. Drive (usually with just the rear wheels) on the raised pavement of the truck apron to navigate more easily. [Nevada Driver Handbook](#), (pg. 40)
5. If approached by an emergency vehicle or official vehicle with flashing lights, you shall immediately drive to a position parallel to, and as close as possible to, the right-hand edge or curb of a highway clear of any intersection, and shall stop and remain until the emergency vehicle has passed. [Nevada Revised Statute 484B.267](#)

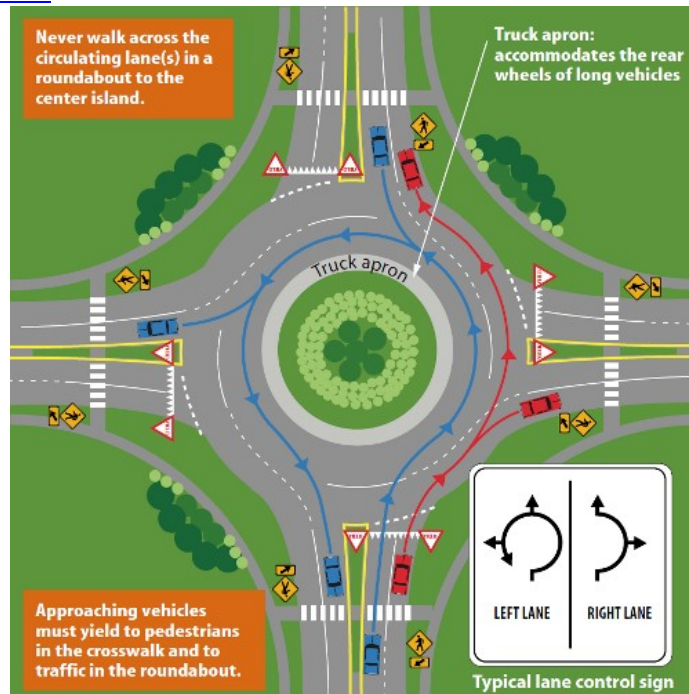

SIGNALING, TURNING, LANE CHANGES AND PASSING

Unit A3.3 Communications/Signaling

Signaling

Using signals to tell others that you are going to change lanes, turn, slow down, stop or park is required by state law. You are required to signal your intentions by continuously signaling not less than:

1. 100 feet in a business or residential area; or
2. 300 feet in any other area.

[Nevada Revised Statue 484B.413](#)

Turning

1. To make safe and legal turns, you must:
 - a. Get into the correct lane well in advance;
 - b. Look ahead, behind and to each side of your vehicle;
 - c. Be aware of other drivers, pedestrians and bicyclists;
 - d. Signal your turn at least 100 feet ahead (about 10 car lengths) on city streets and 300 feet (30 car lengths) on open highways;
 - e. Watch for and obey traffic signals, signs and pavement markings that direct your movement;
 - f. Allow time and space to make your turn safely – slow down;
 - g. Yield the right-of-way to pedestrians, bicyclists and other traffic;
 - h. Steer through the turn and accelerate to the speed of traffic; and
 - i. Be sure your turn signal is off after you enter the flow of traffic.

2. When turning right you must:

- a. Be in the extreme right-hand travel lane or a lane designated for right turns;
- b. If a single lane is provided for turning, you may only enter the lane if you are making a right turn, and may not travel through an intersection while driving in the right-turn lane;
- c. Turn into the right-hand lane of the roadway you are entering, or the lane designated for the turn; and
- d. If you need to change lanes, signal and proceed carefully to the next lane when you are well away from the intersection.

3. When turning left you must:

- a. Keep your wheels pointed straight ahead until you begin to actually complete the turn;
- b. On a two-way road, use the lane just to the right of the center line, and complete the turn into the traffic lane closest to you going in your intended direction; and
- c. Do not attempt to change lanes until you can do so safely.

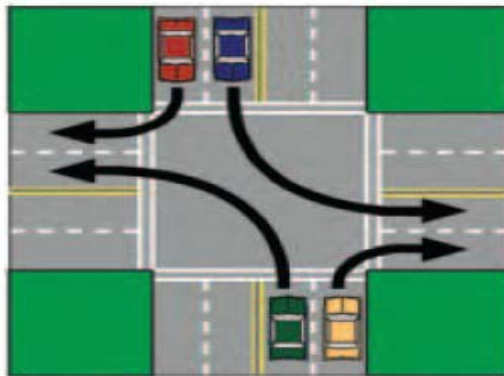

Lane changes

1. When you want to change lanes you must:

- a. Use your mirrors, doing a 5-count mirrors to check for

traffic;

- b. Signal 100 feet (10 car lengths) on city streets, 300 feet (30 car lengths) on highways or freeways before changing lanes;
- c. Check blind spots by looking over your shoulder and change lanes when traffic is clear; and
- d. Do not change lanes in an intersection.
[Nevada Driver Handbook](#), (pg. 44)

**Changing lanes while traveling through
an intersection is prohibited!**

Passing

1. Safe passing rules depend on the type of street or highway you are using. School buses are big and heavy and passing should only occur when **ABSOLUTELY** necessary.
2. You should never exceed the speed limit to pass another vehicle and you can never use the shoulder of the road to pass.
3. On two-lane roads where traffic moves in opposite directions, you may pass on the left only when:
 - a. You can see clearly ahead and there is no immediate oncoming traffic;
 - b. There is a broken yellow line on the highway or when the broken yellow line is in your lane; and
 - c. It is safe to do so.

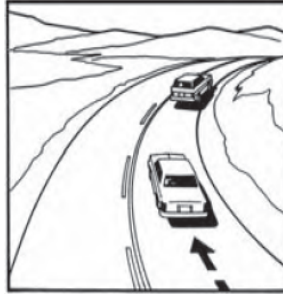

4. When passing on a two-lane road, turn your left signal light on 100 feet ahead in business or residential areas or 300 feet ahead in other areas. After you have passed, pull back into your lane when you can see the vehicle you passed in your rear-view mirror.
5. You must **NOT PASS** on a two-lane road:
 - a. When coming to a curve or the top of a hill where you cannot see far enough ahead to be sure it is safe;
 - b. Within 100 feet of a street crossing;
 - c. Within 100 feet of a railroad crossing;
 - d. Where there is a double solid yellow line on the highway;
and
 - e. Where signs prohibit passing.

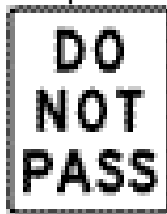

6. When **another vehicle** comes up behind yours and signals to pass, move to the right without leaving your travel lane and let it pass. Never speed up when another vehicle is passing you.
7. On **multi-lane streets** and **highways** you may pass vehicles traveling in the same direction on the left if there are no signs or highway markings that indicated passing is not allowed and it can be done safely. Remember to signal, do a 5-count mirror

check for traffic and look over your shoulder before moving out of your lane. Never pass to the left of a driver who is making or signaling a left turn.

8. You may **pass on the right** if the street or highway is clearly marked for two or more lanes of traffic moving in the same direction you are, but only when passing is safe. Passing on the right is very dangerous if the other driver does not see you and decides to change lanes. Remember to signal, do a 5-count mirror check and check your blind spots before you change lanes.



9. **Passing bicyclists.** When passing a cyclist, a motorist must:
 - a. Move into the lane to the left if more than one lane for traffic in the same direction exists and doing so is reasonably safe;
 - b. If an adjacent lane does not exist, pass to the left of the bicycle at a safe distance, which must be at least three feet;
 - c. You may not move back to the right until the vehicle is safely clear of the bicycle;
 - d. Passing or traveling in a marked bicycle lane is prohibited; and [Nevada Revised Statute 4848B.270](#)
 - e. School bus drivers may cross a bike lane to enter the emergency/turn lane for the purposes of loading and unloading students.
[Nevada Driver Handbook](#), (pg. 46)



SCHOOL AREAS AND SCHOOL ZONES



School Zone



School Zone Crossing

Speed Limit in School Zones

1. In school zones the speed limit is either 15 or 25 mph. These speed limits are in effect on school days from half an hour before school begins to half an hour after school ends, unless otherwise posted.
2. Some areas may use flashing yellow lights to tell you when the speed limit is in effect. Signs and signals clearly show these speed limits and designate the hours when the speed limit is in effect or that the speed limit is in affect when children are present.

[Nevada Driver Handbook](#), (pg. 33) and [Nevada Revised Statute 484B.636](#)



Safety Zones

1. Safety zones are designated areas which are used exclusively for pedestrians. You are prohibited from driving through or within a

safety zone. [Nevada Revised Statue 484B.110](#)

2. School zones are considered safety zones. There are additional penalties for tickets received in designated safety zones. [Nevada Revised Statue 484B.135](#)

Passing and U-Turns in School Zones

1. Nevada state law prohibits vehicles from overtaking and passing another vehicle that has stopped in a designated school zone. This includes school buses passing other school buses that have stopped to load or unload students.
2. You are also not allowed to make a U-turn in a designated school zone or school crossing zone. [Nevada Revised Statue 484B.363](#)
3. It is illegal for school bus drivers to pass other school buses that have stopped, with red lights flashing and stop arms activated.



SECTION 4: SCHOOL BUS DRIVER RESPONSIBILITIES, DUTIES & REQUIRED KNOWLEDGE & SKILLS

SCHOOL BUS DRIVER RESPONSIBILITIES

School bus drivers have additional responsibilities that include:

1. Being familiar with and abide by all federal, state and school rules, policies and procedures that affect student transportation.
2. Report to work with a professional attitude, emotionally and physically prepared to transport students.
3. Recognizing the importance of establishing appropriate rapport with students, parents, their supervisors, and school or Center administrators to ensure proper student management.
4. Instructing students and demonstrating safe and appropriate behavior, consequences of improper behavior, general procedures, seat belt use and proper adjustment, evacuation drills and safe travel practices.
5. Maintaining order and safety, and protect the rights of others on the school bus.
6. Exercise good judgment, using appropriate verbal intervention. This includes, but is not limited to, the following:
 - a. Minimizing interior noise;
 - b. Controlling passenger movement;
 - c. Requiring an orderly entrance and exit;
 - d. Eliminating movement or potential movement of objects; and
 - e. Requiring silence at railroad crossings.
7. Prohibiting transportation of unauthorized materials.

8. Handle minor infractions with school approved, on-board consequences and discussions approved by the school district or agencyhead.
9. In instances of serious or recurring misconduct, follow school policies pertaining to misconduct and submit written reports on appropriate forms to the administrator, your supervisor or the designated authority who can deal with discipline problems.
10. Represent your school by presenting a positive image in dress, language, and manner while on duty, including when you're off duty.
11. The school bus driver making a planned and systematic inspection of the bus before each route and/or trip, or to assure that the inspection has been completed properly and in a timely manner.
12. Know federal rules and regulations on confidentiality, including the Health Insurance Portability and Accountability Act (HIPAA), Family Educational Rights and Privacy Act (FERPA) and Individuals with Disabilities Education Act (IDEA).
[National School Transportation Specifications & Procedures, 2015](#), (pg. 138)
13. Be considerate and patient with all children, especially the young or special needs student.
14. Keep the bus clean at all times, including route and extra-curricular trips.
15. It is highly recommended that you keep a daily log of events.
16. Monitor and supervise children with appropriate management and discipline of disruptive pupils who threaten the safety of other students.
17. Never allow unauthorized people to board or enter your school bus.

ADDITIONAL NEVADA REQUIREMENTS

In addition to federal requirements, Nevada school bus drivers must:

1. Be of good, reputable and sober character.
2. Be competent and qualified by experience, attitude and disposition.

3. Have GOOD PERSONAL HYGIENE and dress in an appropriate manner according to your school's policy.
4. Be physically qualified and able to perform all duties required of a school bus driver, as required by your school.
5. Have successfully complete a state approved training course which includes at least 20 hours of training while operating a school bus and at least 20 hours of classroom training that must include:
 - a. The responsibilities of drivers;
 - b. The requirements for drivers of school vehicles;
 - c. The appropriate management and discipline of disruptive pupils who threaten the safety of other pupils or the driver while riding in a school bus or at the school bus stop;
 - d. The laws affecting the operation of a school bus or vehicle belonging to a school;
 - e. Defensive driving;
 - f. Emergency procedures; and
 - g. First aid and CPR training.

[Nevada Revised Statute 386.825](#)

Note: School bus driver training must be conducted by a Nevada State Certified School Bus Driver Trainer.

[Nevada Administrative Code 386.530](#)

3. Conduct pre, post and anytime the bus is left unattended inspections.
4. Pass the State of Nevada School Bus Driver Written Examination with a score of 80% or higher each year annually. [Nevada Administrative Code 386.510](#)

Each school has the authority to develop policies and procedures that exceed state and federal requirements.

SCHOOL BUS DRIVER DUTIES

School bus drivers have additional duties that include:

1. Refraining from the use of stimulants, sedatives and alcoholic beverages.
2. Being responsible for the safe operating condition and cleanliness of the bus.
3. Only using the school bus to transport students on established routes and schedules approved by your school.
4. Never allowing someone else to drive the school bus without the proper licenses and prior school approval.
5. Never allowing unauthorized people to enter your bus.
6. Being responsible for any traffic tickets and fines you receive while driving a school bus for a school.
7. Reporting any and all bus crashes or incidents that occur in the bus, regardless of damage.
8. Be familiar with written instructions of the assigned route that would include any existing railroad crossing and any fixed route hazard(s).
9. Having a planned and systematic inspection of the bus before each route and/or trip. This requires both a stationary and operating inspection during the pre-trip, post-trip and anytime the bus has been left unattended inspections. Report any needed repair.
10. Assuring that all students are able to cross the road safely.
11. Keeping accurate school bus inspection logs and submitting all reports when required.

12. Conducting the required emergency evacuation drills for regular and special education students twice yearly.
13. Not dropping a student off anywhere other than their scheduled drop off point without prior approval from your school.
14. Being familiar with assigned routes and designated school bus stops; Maintain a clean bus, including all route and extra- curricular activities.
15. Always having a positive attitude!

REQUIRED KNOWLEDGE AND SKILLS

Required Knowledge

School bus drivers are required to have basic knowledge in the following areas.

1. **Safe operations regulations.** Drivers are required to have the following knowledge:
 - a. Inspection, repair, and maintenance requirements;
 - b. Nevada School Bus Out-of-Service Criteria;
 - c. Procedures for safe vehicle operations;
 - d. The effects of fatigue, poor vision, hearing impairment, and general health; and
 - e. The effects of alcohol and drug use.
[Federal Motor Carrier Safety Regulation 383.111, Required Knowledge](#)
2. **Safe vehicle control systems.** Know the purpose and function of the controls and instruments found in the school bus. [Federal Motor Carrier Safety Regulation 383.111, Required Knowledge](#)
3. **Safety control systems.** Proper use of the school bus safety system, including lights, horns, side and rear-view mirrors, proper mirror adjustment, fire extinguisher, symptoms of improper operation revealed through instruments, school bus operational characteristics, and diagnosing malfunctions. Drivers must have knowledge of the correct

procedures needed to use safety systems in an emergency situation.

4. **Basic control.** The procedures for performing various basic maneuvers:
 - a. Starting, warming up, and shutting down the engine;
 - b. Putting the bus in motion and stopping the bus;
 - c. Backing in a straight line; and
 - d. Turning the bus, basic rules, off- tracking, right/left turns and right curves.
[Federal Motor Carrier Safety Regulation 383.111, Required Knowledge](#)

5. **Shifting.** The basic shifting rules and terms common on Transmissions, including:
 - a. Key elements of shifting, e.g., controls, when to shift, and double clutching;
 - b. Shift patterns and procedures; and
 - c. Consequences of improper shifting.
[Federal Motor Carrier Safety Regulation 383.111, Required Knowledge](#)

6. **Backing.** The procedures and rules for various backing maneuvers:
 - a. Backing principles and rules; and
 - b. Basic backing maneuvers, e.g., straight-line backing, and backing on a curved path.
[Federal Motor Carrier Safety Regulation 383.111, Required Knowledge](#)

7. **Visual search.** The importance of proper visual search, and proper visual search methods:
 - a. Seeing ahead and to the sides;
 - b. Use of mirrors; and

- c. Seeing to rear.
[Federal Motor Carrier Safety Regulation 383.111, Required Knowledge](#)
- 8. **Communication.** The principles and procedures for proper communications and the hazards of failure to signal properly.
 - a. Signaling your intentions;
 - b. Communicating your presence; and
 - c. Misuse of communications devices.
[Federal Motor Carrier Safety Regulation 383.111, Required Knowledge](#)
- 9. **Speed management.** The importance of understanding the effects of speed:
 - a. Speed and stopping distance;
 - b. Speed and surface conditions;
 - c. Speed and the shape of the road;
 - d. Speed and visibility; and
 - e. Speed and traffic flow
[Federal Motor Carrier Safety Regulation 383.111, Required Knowledge](#)
- 10. **Space management.** Procedures and techniques for controlling the space around your bus:
 - a. The importance of space management;
 - b. Space cushions;
 - c. Space to the sides; and
 - d. Space for traffic gaps.
[Federal Motor Carrier Safety Regulation 383.111, Required Knowledge](#)

11. **Night operation.** Preparations and procedures for driving at night.
 - a. Night driving factors such as vision, glare, fatigue and inexperience.
 - b. Roadway factors such as low illumination, variation in illumination, unfamiliarity with roads and other road users exhibiting erratic or improper driving.
 - c. Vehicle factors including headlights, auxiliary lights, turn signals, windshields and mirrors.
[Federal Motor Carrier Safety Regulation 383.111, Required Knowledge](#)

12. **Extreme driving conditions.** Basic information on operating in extreme driving conditions:
 - a. Bad weather such as snow, ice, sleet and high wind;
 - b. Hot weather; and
 - c. Mountain driving.
[Federal Motor Carrier Safety Regulation 383.111, Required Knowledge](#)

13. **Hazardous perceptions.** Basic information on hazard perception and clues for recognizing hazards.
 - a. Road characteristics; and
 - b. Road user activities.
[Federal Motor Carrier Safety Regulation 383.111, Required Knowledge](#)

14. **Emergency maneuvers.** Basic information concerning when and how to make emergency maneuvers:
 - a. Evasive steering;
 - b. Emergency stopping;
 - c. Off road recovery;

- d. Brake failure; and
 - e. Blowouts.
[Federal Motor Carrier Safety Administration 383.111](#)
15. **Skid control and recovery.** Information on the causes and major types of skids, as well as the procedures for recovery from skids.
[Federal Motor Carrier Safety Regulation 383.111, Required Knowledge](#)
16. **Vehicle inspections.** The objectives and proper procedures for performing school bus inspections.
- a. The importance of periodic inspection and repair to vehicle safety.
 - b. The effect of undiscovered malfunctions upon safety.
 - c. What safety-related parts to look for when inspecting the school bus such as fluid leaks, interference with visibility, bad tires, wheel and rim defects, braking system defects, steering system defects, suspension system defects and exhaust system defects.
[Federal Motor Carrier Safety Regulation 383.111, Required Knowledge](#)
 - d. Pre-trip, during a trip, post-trip, enroute/roadside inspection procedures.
 - e. Reporting findings.
 - f. Be familiar with Nevada School Bus Out-of-Service Criteria.
17. **Mountain driving.** Practices that are important when driving upgrade and downgrade:
- a. Selecting a safe speed;
 - b. Selecting the right gear; and
 - c. Proper braking techniques.
[Federal Motor Carrier Safety Regulation 383.111, Required Knowledge](#)
18. **Fatigue and awareness.** Practices that are important to staying alert and safe when driving:

- a. Being prepared to drive;
- b. What to do when driving to avoid fatigue;
- c. What to do when sleepy while driving; and
- d. What to do when becoming ill while driving.
[Federal Motor Carrier Safety Regulation 383.111, Required Knowledge](#)

19. **Air brakes.** If your school bus is equipped with air brakes, you must have knowledge in the following areas:

- a. General air brake system components and terminology;
- b. The dangers of contaminated air supply (dirt, moisture, and oil);
- c. Implications of severed or disconnected air lines;
- d. Implications of low air pressure readings;
- e. Procedures to conduct safe and accurate pre-trip inspections:
 - ✓ Automatic fail-safe devices;
 - ✓ System monitoring devices; and
 - ✓ Low pressure warning alarms.
- f. Procedures for conducting end-route and post-trip inspections of air-actuated brake systems:
 - ✓ Ability to detect defects that may cause the system to fail;
 - ✓ Tests that indicate the amount of air loss from the braking system within a specified period, with and without the engine running; and
 - ✓ Tests that indicate the pressure levels at which the low air pressure warning devices should activate.
[Federal Motor Carrier Safety Regulation 383.111, Required Knowledge](#)

g. General operating practices and procedures:

- ✓ Proper braking techniques;
- ✓ Antilock brakes;
- ✓ Emergency stops; and
- ✓ Parking brake.

[Federal Motor Carrier Safety Regulation 383.111, Required Knowledge](#)

Driving a school bus is a tremendous responsibility!

Required Skills

School bus drivers must also have the following required skills:

1. **Inspection skills.** Must possess basic vehicle inspection skills and be able to identify each safety- related part on the vehicle and explain what needs to be inspected.
 - a. Engine Compartment;
 - b. Cab/engine start;
 - c. Steering;
 - d. Suspension;
 - e. Brakes;
 - f. Wheels;
 - g. Side of vehicle;
 - h. Rear of vehicle;
 - i. Special equipment specific to the school bus; and

- j. Air brake equipped buses must demonstrate the following skills with respect to inspection and operation of air brakes:
- ✓ Locate and verbally identify air brake controls and monitoring devices.
 - ✓ Determine that the brake system condition for proper adjustments and that air system connections have been properly made and secured.
 - ✓ Inspect the low pressure warning device to ensure that it will activate in emergency situations.
 - ✓ With the engine running, make sure that the system maintains an adequate supply of compressed air.
 - ✓ Determine that the required minimum air pressure build up time is acceptable limits and that required alarms and emergency devices automatically deactivate at the proper pressure level.
 - ✓ Operationally check the brake system for proper performance.
- [Federal Motor Carrier Safety Regulation 383.113, Required Skills](#)

2. **Basic vehicle control skills.** Must demonstrate the following basic motor vehicle control skills for the school bus.
- a. Ability to start, warm up, and shut down the engine.
 - b. Ability to put the school bus in motion and accelerate smoothly, forward and backwards.
 - c. Ability to bring the school bus to a smooth stop.
 - d. Ability to back the school bus up in a straight line and check path and clearance while backing.
 - e. Ability to position the school bus to negotiate safely and then make left and right turns.

- f. Ability to shift as required and select the appropriate gear for speed and highway conditions; and
 - g. Ability to back along a curved path. [Federal Motor Carrier Safety Regulation 383.113, Required Skills](#)
3. **Safe on-road driving skills.** Be able to demonstrate the following safe on-road driving skills.
- a. Ability to use proper visual search methods.
 - b. Ability to signal appropriately when changing direction in traffic.
 - c. Ability to adjust speed to the condition of the roadway, weather and visibility conditions, traffic conditions, motor vehicle and driver conditions.
 - d. Ability to choose a safe gap for changing lanes, passing other vehicles and crossing or entering traffic.
 - e. Ability to position your school bus correctly before and during a turn to prevent other vehicles from passing you on the wrong side, as well as to prevent problems caused by off-tracking.
 - f. Ability to maintain a safe following distance depending on the condition of the road, visibility and vehicle weight.
 - g. Ability to adjust operation of the vehicle to prevailing weather conditions including speed selection, braking, direction changes and following distance to maintain control.
 - h. Ability to observe the road and the behavior of other motor vehicles, particularly before changing speed and direction. [Federal Motor Carrier Safety Regulation 383.113, Required Skills](#)

School bus drivers are required to have additional knowledge and skills that are specific to transporting students.

REQUIRED ENDORSEMENTS FOR SCHOOL BUS DRIVERS

1. School bus drivers are required to have a Passenger (P) and School Bus (S) Endorsement on your CDL license.
2. In order to receive a passenger (P) endorsement on your CDL, you must satisfy the following additional knowledge and skills test requirements:
 - a. Knowledge Test for a Passenger (P) Endorsement:
 - b. Proper procedures for loading/unloading passengers;
 - c. Proper use of emergency exits, including push-out windows;
 - d. Proper responses to such emergency situations as fires and unruly passengers;
 - e. Proper procedures at railroad-highway grade crossings and drawbridges; and
 - f. Proper braking procedures.
[Federal Motor Carrier Safety Regulation 383.117, Requirements for Passenger Endorsement](#)
3. Knowledge test for a School Bus (S) Endorsement:
 - a. Loading and unloading children, including the safe operation of stop signal devices, external mirror systems, flashing lights and other warning and passenger safety devices required for school buses.
 - b. Emergency exits and procedures for safely evacuating passengers in an emergency.
 - c. Laws regarding railroad-highway grade crossings.
 - d. Operating practices and procedures.
[Federal Motor Carrier Safety Regulation 383.123, Requirements for School Bus Endorsement](#)

SECTION 5: BASIC CONTROL OF YOUR SCHOOL BUS

Unit B1.1.4 Basic Control

ACCELERATING

Don't roll back when you start. You may hit someone behind you. If you have a manual transmission vehicle, partly engage the clutch before you take your right foot off the brake. Put on the parking brake whenever necessary to keep from rolling back. Release the parking brake only when you have applied enough engine power to keep from rolling back.

Speed up smoothly and gradually so the vehicle does not jerk. Rough acceleration can cause mechanical damage.

Speed up gradually when traction is poor, as in rain or snow. If you use too much power, the drive wheels may spin. You can lose control if the drive wheels begin to spin, take your foot off the accelerator.

[Nevada Commercial Driver License Manual](#), (pg. 2-8)

BACKING SAFELY

Unit B1.1.6

Backing a school bus is **STRONGLY DISCOURAGED**. Because you cannot see everything behind your bus, backing is always dangerous. Avoid backing and look for ways to go around instead of backing up. When you park, try to park so you will be able to pull forward when you leave.

You **CANNOT** back up a school bus when students are outside or around the bus. You can only back up the bus when all students are on board. Backing is dangerous!

1. Nevada Law states that the driver of a vehicle:
 - a. Shall not back the vehicle unless such movement can be made with reasonable safety and without interfering with other traffic;
 - b. Shall not back into an intersection, on or over a crosswalk, or around a street corner; and

- c. Shall in every case yield the right-of-way to moving traffic and pedestrians.

[Nevada Revised Statute 484B.113](#)

2. If you must back up:

- a. Start in the proper position. Put the bus in the best position to allow you to back safely and only once;
- b. Look at your path. Look at your path before you begin and do not back the vehicle unless such a movement can be made safely without interfering with other traffic;
- c. Use mirrors on both sides. Constantly check all mirrors, using the 5-count mirror check;
- d. Back into, not out of a space;
- e. Always back as SLOWLY as possible;
- f. Back and turn toward the driver's side. Back to the driver's side so that you can see better. Backing toward the right side is very dangerous because you can't see as well. If you back and turn toward the driver's side, you can watch the rear of your vehicle by looking out the side window. Use driver-side backing, even if it means going around the block to put your vehicle in this position. The additional safety is worth it;
- g. Use a Helper or spotter. Use a helper when you can. The helper should stand near the back of your bus where the driver can see the helper. Before you begin backing, work out a hand signal you both understand which means STOP. [Nevada Commercial Driver License Manual](#), (pg. 2-8)
- h. If a helper/spotter is not available:
 - ✓ Set the parking brake;
 - ✓ Turn off the motor and take the keys with you; and
 - ✓ Walk to the rear of the bus to determine whether the way is clear.

- i. Do not back into an intersection (two Highways/roadways which join one another at a point), on or over a crosswalk, or around a street corner; [Nevada Revised Statue 484A.105](#)
- j. Make sure all students are on board before you back up the bus;
- k. Honk your horn so others know you are backing up the bus; and
- l. Yield the right-of-way to moving traffic and pedestrians. [Nevada Revised Statue 484B.113](#)

STOPPING THE BUS

1. Push the brake pedal down gradually. The amount of brake pressure you need to stop the vehicle will depend on the speed of the vehicle and how quickly you need to stop. Control the pressure so the vehicle comes to a smooth and safe stop.
2. Since school buses are much heavier than other vehicle so it requires the driver to begin braking earlier in order to stop smoothly.
3. Brakes, tires, springs, and shock absorbers on heavy vehicles are designed to work best when the vehicle is fully loaded. Empty trucks require greater stopping distances because an empty vehicle has less traction.
4. Get the big picture and begin slowing down far in advance of the stop.
5. Feather the brake by slightly reducing pressure on the brake pedal. This action will release a small amount of brake pressure right before the stop is complete, making a smoother stop.
6. Never stop suddenly unless absolutely necessary to avoid a collision. Students could be thrown around the bus.
7. Always maintain a safe following distance. The following distance should be long enough for you to be able to safely and smoothly stop the bus under any condition.
8. Short stopping/brake check is not acceptable for stopping the bus. [Nevada Commercial Driver License Manual](#), (pg. 2-8)

TURNING THE BUS AROUND

If you must turn the bus around, you need to have at least 500 feet of unobstructed visibility in both directions and plenty of room to turn the bus around.

1. Select an area that is large enough to turn around without backing up the bus;
2. Slowly move the bus forward in a wide circle to turn around;
3. Turn around only at places designated by your district transportation department; and
4. Always keep the bus in the proper lane of travel.

COMMUNICATING

Unit A1.2.2 Communication and Unit A3.3 Communications/Signaling

Signaling your Intentions

Signaling what you intend to do is important for safety. Here are some general rules for signaling.

1. **Turns.** There are three good rules for using turn signals:
 - a. **Signal early** well before you turn. This is the best way to keep others from trying to pass you;
 - b. **Signal continuously.** You need both hands on the wheel to turn safely. Don't cancel the turn signal until you have completed the turn; and
 - c. **Cancel your signal.** Don't forget to turn off your turn signal after you've completed the turn (if you don't have self-cancelling signals).
2. **Lane changes.** Put your turn signal on 100 in residential and 300 feet on a highway before changing lanes. Change lanes slowly and smoothly. That way a driver you may not see may have a chance to honk his/her horn or avoid your vehicle.
3. **Slowing down.** Warn drivers behind you when you plan to slow

down. A few light taps on the brake pedal, enough to flash the brake lights, should be sufficient to warn drivers who are following you.

4. **Trouble ahead.** The size of your vehicle may make it hard for drivers behind you to see hazards ahead. If you see a hazard that will require slowing down, warn the drivers behind by tapping your brake lights and use your four-way hazard lights.
5. **Tight turns.** Most car drivers don't know how slowly you have to go to make a tight turn in a large vehicle. Give drivers behind you warning by braking early and slowing gradually.
6. **Stopping on the road.** Bus driver's sometime stop in the roadway to load and unload passengers, or to stop at a railroad crossing. Warn following drivers by tapping your brakes and don't stop suddenly.
7. **Drive slowly.** Drivers often do not realize how fast they are catching up to a slow vehicle until they are very close. If you must drive slowly, alert following drivers by turning on your emergency flashers. [Nevada Commercial Driver License Manual](#), (pg. 2-11)
8. Four Way Emergency Flashers. You can use your four-way emergency flashers:
 - a. When you pull off the road and stop; [Nevada Commercial Driver License Manual](#), (pg. 2-12)
 - b. When an unusual traffic hazard exists. [Nevada Revised Statute 484D.185](#)<add>
9. **When passing.** Whenever you are about to pass a vehicle, pedestrian, or bicyclist, assume they don't see you. They could suddenly move in front of your vehicle. When it is legal, tap the horn lightly or, at night, flash your lights from low to high beam and back. And, drive carefully enough to avoid a crash even if they don't see or hear you.
10. **When it's hard to see.** At dawn, dusk, in rain, or snow, you need to make yourself easier to see. If you are having trouble seeing other vehicles, other drivers will have trouble seeing you. Turn on your lights. Use the headlights, not just the identification or clearance

lights. Use the low beams; high beams can bother people in the daytime as well as at night.

11. **When parked at the side of the road.** When you pull off the road and stop, be sure to turn on the four-way emergency flashers. This is especially important at night.
12. **If you must stop.** If you must stop on a road or shoulder of any road, activate your four-way hazards, and put out your emergency warning devices within ten minutes. Place your warning devices at the following locations:
 - a. On a one-way or divided highway, place warning devices 10 feet, 100 feet, and 200 feet toward the approaching traffic.

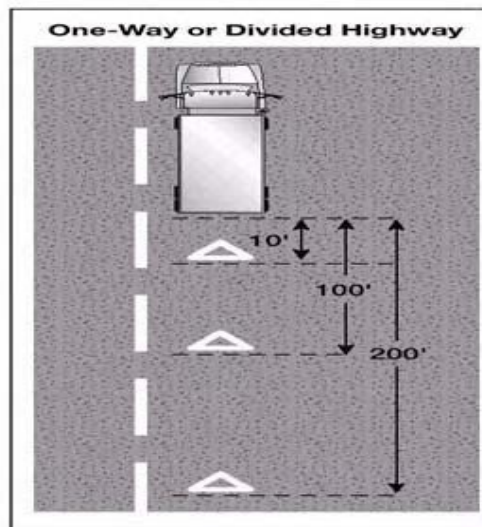

- b. On a two-lane road carrying traffic in both directions or on an undivided highway, place warning devices within 10 feet of the front or rear corners or mark the location of the vehicle and 100 feet behind and ahead of the vehicle, on the shoulder or in the lane you stopped in.

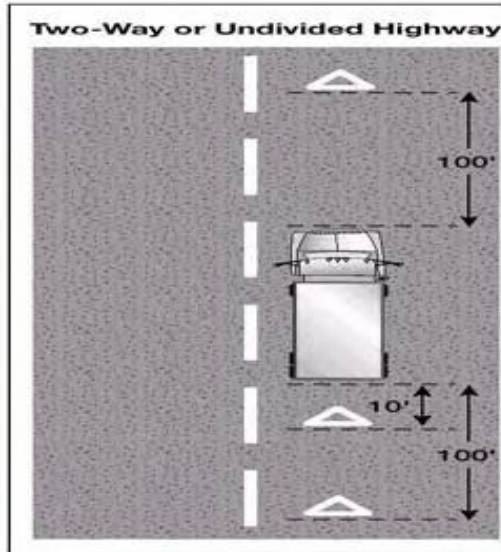

- c. Back beyond any hill, curve, or other obstruction that prevents other drivers from seeing the vehicle within 500 feet.
[Nevada Commercial Driver License Manual](#), (pg. 2-12)

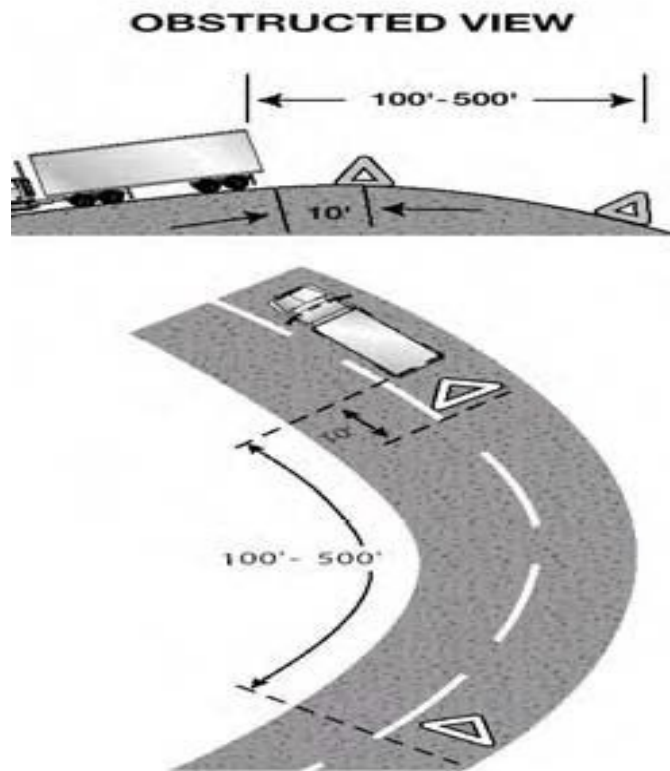

CONTROLLING SPEED

Unit A1.2.4 Speed Management and Unit B3.5 Speed and Space Management

Driving too fast is a major cause of fatal crashes. You must adjust your speed

depending on driving conditions. This includes traction, curves, visibility, traffic and hills.

1. Total Stopping Distance

$$\begin{aligned} & \text{Perception distance} \\ + & \text{Reaction distance} \\ + & \text{Brake lag distance (for vehicles with air brakes)} \\ + & \text{Braking distance} \\ = & \textbf{Total stopping distance} \end{aligned}$$

- a. **Perception distance.** Perception distance is the distance your vehicle travels in ideal conditions; from the time your eyes see a hazard until your brain recognizes it. Keep in mind certain mental and physical conditions can affect your perception distance. It can be affected greatly depending on visibility and the hazard itself.
The average perception time for an alert driver is 1 3/4 seconds. At 55 mph this accounts for 142 feet traveled.
- b. **Reaction distance.** Reaction Distance is the distance you will continue to travel, in ideal conditions; while you are braking. At 55 mph on dry pavement with good brakes, it can take about 216 feet.
- c. **Brake distance.** Brake distance is the distance your vehicle will travel, in ideal conditions; while you are braking. At 55 mph on dry pavement with good brakes, it can take about 216 feet.
- d. **Total stopping distance.** Your total stopping distance is the total minimum distance your vehicle has traveled, in ideal conditions; with everything considered, including perception distance, reaction distance and braking distance, until you can bring your vehicle to a complete stop. At 55 mph, your vehicle will travel a minimum of 419 feet.

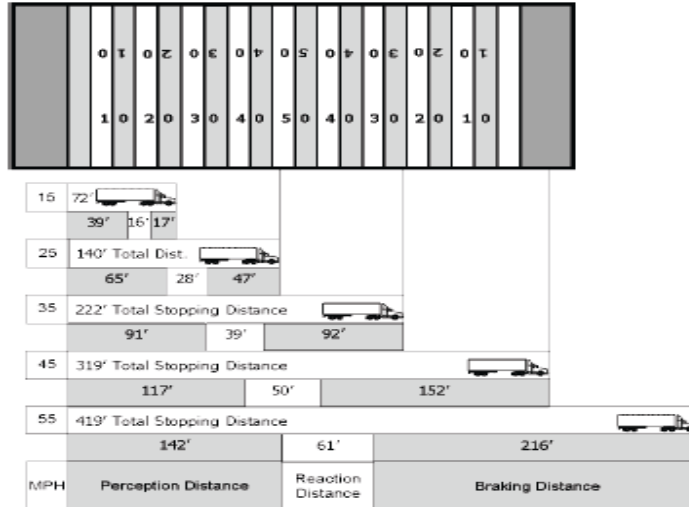

The Effect of Speed on Stopping Distance

The faster you drive, the greater the impact! When you double your speed from 20 to 40 mph the impact is 4 times greater. The braking distance is also 4 times longer. Triple the speed from 20 to 60 mph and the impact and braking distance is 9 times greater. At 60 mph, your stopping distance is greater than the length of a football field. Increase the speed to 80 mph and the impact and braking distance are 16 times great than at 20 mph. High speeds greatly increase the severity of crashes and stopping distances. By slowing down, you can reduce braking distance.

The Effect of Vehicle Weight on Stopping Distance

The heavier the vehicle, the more work the brakes must do to stop it and the more heat they absorb. But the brakes, tires, springs, and shock absorbers on heavy vehicles are designed to work best when the vehicle is fully loaded. Empty CMV's require greater stopping distances because an empty vehicle has less traction.

[Nevada Commercial Driver License Manual](#), (pg. 2-13)

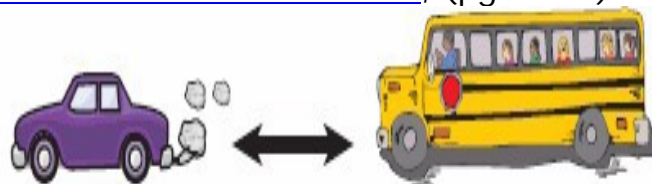

Speed and Curves

Drivers must adjust their speed for curves in the road. If you take a curve

too fast, two things can happen. The tires can lose their traction and continue straight ahead, so you skid off the road. Or the tires may keep their traction and the vehicle rolls over. Tests have shown that trucks with a high center of gravity can roll over at the posted speed limit for a curve.

Slow to a safe speed BEFORE you enter a curve. Braking in a curve is dangerous because it is easier to lock the wheels and cause a skid. Slow down as needed. Don't exceed the posted speed limit for the curve. Be in a gear that will let you accelerate slightly in the curve. This will help with control.

[Nevada Commercial Driver License Manual](#), (pg. 2-14)

Speed and Distance Ahead

You should always be able to stop within the distance you can see ahead. Fog, rain or other conditions may require that you slowdown to be able to stop in the distance you can see. At night, you can't see as far with low beams as you can with high beams. If you must use low beams, slow down. [Nevada Commercial Driver License Manual](#), (pg. 2-15)

Speed and Traffic Flow

When you're driving in heavy traffic, the safest speed is the speed of other vehicles. Vehicles going the same direction at the same speed are not likely to run into one another. Drive at the speed of the traffic, if you can without going at an illegal or unsafe speed. Keep a safe following distance.

The main reason drivers exceed speed limit's is to save time. But, anyone trying to drive faster than the speed of traffic will not be able to save much time. The risks involved are not worth it. If you go faster than the speed of other traffic, you'll have to keep passing other vehicles. This increases the chance of a crash, and it is more tiring. Fatigue increases the chance of a crash.

When driving on slippery surfaces, NEVER USE engine brakes or CRUISE CONTROL!

[Nevada Commercial Driver License Manual](#), (pg. 2-15)

Speed on Downgrades

Your vehicle's speed will increase on downgrades because of gravity. Your

most important objective is to select and maintain a speed that is not too fast for the:

1. Total weight of the vehicle and the passengers;
2. Length of the grade;
3. Steepness of the grade;
4. Road condition; and
5. Weather.

[Nevada Commercial Driver License Manual](#), (pg. 2-15)

Matching Speed to the Road Surfaces

You can't steer or use your brakes to stop a vehicle unless you have traction. Traction is friction between the tires and the road. There are some road conditions that reduce traction and call for lower speeds.

SLIPPERY SURFACES

It will take longer to stop, and it will be harder to turn without skidding, when the road is slippery. Wet roads can double stopping distance. You must drive slower to be able to stop in the same distances on a dry road. Reduce speed by about one third (e.g., slow from 55 to 35 mph) on a wet road. On packed snow, reduce speed by half, or more. If the surface is icy, reduce speed to a crawl and stop driving as soon as you can safely do so.

Identifying Slippery Surfaces

Sometimes it's hard to know if the road is slippery. Here are some signs of slippery roads.

1. **Shaded areas.** Shady parts of the road will remain icy and slippery long after open areas have melted.
2. **Bridges.** When the temperature drops, bridges will freeze before the road will. Be especially careful when the temperature is close to 32 degrees Fahrenheit or lower.
3. **Melting ice.** Melting ice is much more slippery than ice that is

not wet.

4. **Black ice.** Black ice is a thin layer that is clear enough that you can see the road underneath it. It makes the road look wet. Anytime the temperature is below freezing and the road looks wet, watch out for black ice.
5. **Vehicle icing.** An easy way to check for ice is to open the window and feel the front of the mirror, mirror support, or antenna. If there's ice on these, the road surface is probably starting to ice up.
6. **Just after rain begins.** Right after it starts to rain, the water mixes with oil left on the road by vehicles. This makes the road very slippery.

Hydroplaning

1. In some weather, water or slush collects on the road. When this happens, your vehicle can hydroplane. It's like water skiing; the tires lose their contact with the road and have little or no traction. You may not be able to steer or brake. You can regain control by releasing the accelerator. This will slow your vehicle and let the wheels turn freely.
2. If the vehicle is hydroplaning, **DO NOT USE THE BRAKES TO SLOW DOWN!**
3. It does not take a lot of water to cause hydroplaning. Hydroplaning can occur at speeds as low as 30 mph if there is a lot of water. Hydroplaning is more likely if tire pressure is low.
4. Road surfaces where water can collect can create conditions that cause a vehicle to hydroplane. Watch for clear reflections, tire splashes, and raindrops on the road. These are indications of standing water.

[Nevada Commercial Driver License Manual](#), (pg. 2-15)

MAXIMUM SPEED LIMITS FOR SCHOOL BUSES

1. School buses **SHALL NOT** exceed 55 mph when transporting students to and from school.

School buses SHALL NOT exceed 55 mph when transporting students to and from school.

2. School buses **CAN** drive the posted speed limit when transporting students to and from activities (extra-curricular, sports, field trips) that are part of the school program.

[Nevada Revised Statute 484B.360](#)

3. School districts have the authority to establish a maximum speed limit.

School buses can drive the posted speed limit when transporting students to and from extra-curricular activity trips.

MANAGING SPACE

Unit A1.2.5 Space Management and Unit A3.5 Speed and Space Management

Space Ahead

1. Of all the space around your bus, it is the area ahead of your vehicle, the space you're driving into, that is most important. Vehicles most often run into the vehicle directly in front of them.
2. In order to have enough space ahead, you need at least one second for each 10 feet of vehicle length at speeds below 40 mph. At greater speeds, you must add one second for safety.
3. To see how much space you should keep in front of you? One good rule says you need at least one second for each 10 feet of vehicle length at speeds below 40 mph. At greater speeds, you must add 1 second for safety. For example, if you are driving a 40-foot vehicle, you should leave 4 seconds between you and the vehicle ahead. In a 60-foot rig, you'll need 6 seconds. Over 40 mph, you'd need 5 seconds for a 40-foot vehicle and 7 seconds for a 60-foot vehicle.
4. To know how much space you have, wait until the vehicle ahead passes a shadow on the road, a pavement marking, or some other clear landmark. Then count off the seconds like this: one thousand-and-one, one thousand-and-two and so on, until you reach the same spot.

[Nevada Commercial Driver License Manual](#), (pg. 2-16)

Space Behind

You can't stop others from following you too closely. But there are things you can do to make things safer:

1. **Stay to the right.** School buses are heavy, slow moving vehicles that are often tailgated. You can prevent other vehicles from tailgating your bus by traveling in the right lane.
2. **Tailgaters.** In large school buses, it is hard to see if a vehicle is close behind you. You may be tailgated:
 - a. If you are traveling slowly; and
 - b. Driving in bad weather.
3. **Dealing with tailgaters safely.** If you find yourself being tailgated, here are some things you can do to prevent the chances of an crash:
 - a. Avoid quick changes;
 - b. Increase your following distance;
 - c. Do not speed up; and
 - d. Avoid tricks that can aggravate other drivers.
[Nevada Commercial Driver License Manual](#), (pg. 2-16)

Space to the Sides

School buses are wide and take up most of a lane. Manage what little space you have by keeping your bus centered in your lane and avoid driving next to others. Here are some hints to help you:

1. Stay centered in your lane.
2. When traveling next to others you need to be extra cautious because:
 - a. Another driver may change lanes suddenly and turn into you;

- b. You may be trapped when you need to change lanes;
- c. You will not be able to leave yourself an out; and
- d. Strong winds can make it difficult to maintain your lane.
[Nevada Commercial Driver License Manual](#), (pg. 2-18)

Space Cushion

The term Space Cushion refers to the clear area you should have around your vehicle. A space cushion is having an escape route if you need to take evasive action. If you cannot maintain your space cushion in one direction, you should be aware of it and leave yourself an out in another direction.

Space Overhead

Hitting overhead objects is a danger because school buses are large. You need to make sure you always have enough overhead clearance.

1. Never assume that the heights posted at bridges and overpasses are correct. Re-paving or packed snow may have reduced the clearance.
2. If you doubt you have enough safe space to pass under an object, take another route and notify your supervisor. Warnings are not always posted.
3. Some roads are uneven and may cause a vehicle to tilt.
4. There can be a problem clearing objects along the edge of the road.
5. Watch out for objects at the side of road like signs, tree branches, electrical wiring or bridge supports. Always drive closer to the center of the road.
6. If you have to back into an area, get out and check for overhanging objects. [Nevada Commercial Driver License Manual](#), (pg. 2-18)

School buses should never drive under an overhead that's less than 12 feet.

Space for Turns

The space around a bus is important in turns. Because of wide turning and off-tracking, large vehicles can hit other vehicles or objects during turns.

1. **Right turns.** Here are some rules to help prevent right-turn crashes.
 - a. Turn slowly to give yourself and others more time to avoid problems.
 - b. If your bus cannot make the right turn without swinging into another lane, turn wide as you complete the turn. Keep the rear of your vehicle close to the curb.
 - c. Don't turn wide to the left as you start the turn. A driver may try to pass you on the right.
 - d. If you must cross into the oncoming lane to make a turn, watch out for vehicles coming toward you.

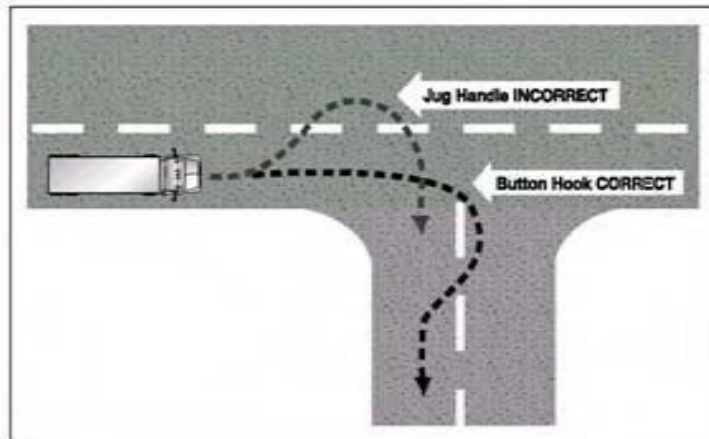

2. **Left turns.** On a left hand turn, make sure you have reached the center of the intersection before you start the left turn. If you turn too soon, the left side of your vehicle may hit another vehicle because of off-tracking.
3. If there are two or more left hand turn lanes, always take the outside right turn lane. Don't start in the inside lane because you may have to swing right to make the turn.

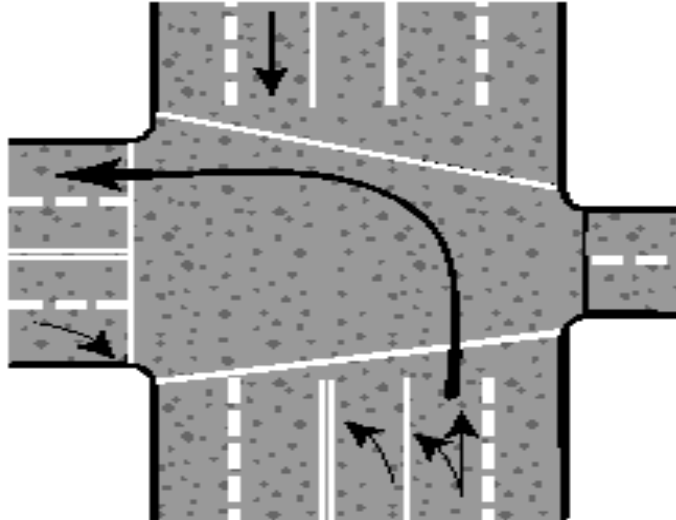

Space Needed to Cross or Enter Traffic

Be aware of the size and weight of your vehicle when you cross or enter traffic. Here are some important things to keep in mind.

1. Because of the slow acceleration and the space large school buses require, you need a much larger gap to enter traffic that you would in your car.
2. Acceleration varies with the load. Allow more room if your school bus is loaded.
3. Before crossing a road, make sure you can get all the way across before traffic reaches you.

[Nevada Commercial Driver License Manual](#), (pg. 2-19)

ADDITIONAL DRIVING REQUIREMENTS FOR SCHOOL BUS DRIVERS

In addition to the above requirements, school bus drivers must also have knowledge and skills in:

1. **Danger zones.** The danger zone is the area on all sides of the bus where children are in the most danger of being hit, either by another vehicle or their own bus. The danger zones may extend as much as 30 feet from the front bumper with the first 10 feet being the most dangerous, 10 feet from the left and right sides of the bus and 10 feet behind the rear bumper of the school bus. In addition, the area to the

left of the bus is always considered dangerous because of passing cars.

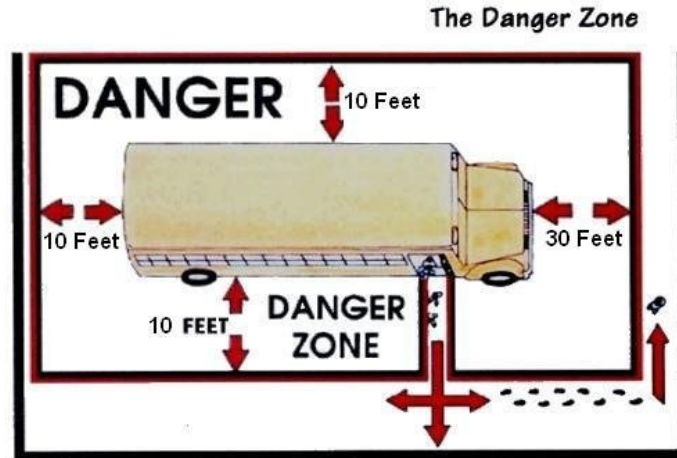

2. **Correct mirror adjustment.** Proper adjustment and use of all mirrors is vital to the safe operation of the school bus in order to observe the danger zone around the bus and look for students, traffic, and other objects in this area. You should always check each mirror before operating the school bus to obtain maximum viewing area. If necessary, have the mirrors adjusted.

[Nevada Commercial Driver License Manual](#), (pg. 10-1)

USING YOUR MIRRORS

Proper adjustment and use of all mirrors is very important to the safe operation of the school bus in order to observe the danger zone around the bus and look for students, traffic and other objects. One of the most important safe driving skills is proper mirror adjustment. Most crashes are the result of improper mirror usage.

Types of Mirrors on School Buses

1. **Flat mirrors.** These mirrors are mounted at the left and right front corners of the bus at the side or front of the windshield. They are used to monitor traffic, check clearances and students on the sides and to the rear of the bus. There is a blind spot behind the bus that extends 50 to 150 feet and could extend up to 400 feet depending on the length and width of the bus.
2. The blind spot is immediately below and in front of each mirror. The blind spot behind the bus extends 50 to 150 feet. Ensure that the mirrors are properly adjusted so you can see:

- a. 200 feet or 4 bus lengths behind the bus;
 - b. Along the sides of the bus; and
 - c. The rear tires touching the ground.
- [Nevada Commercial Driver License Manual](#), (pg. 10-1)

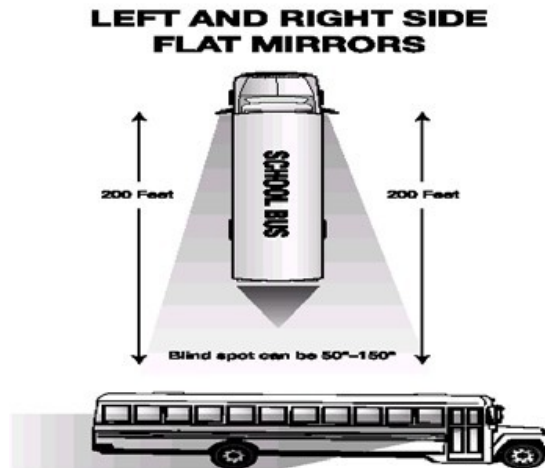

3. **Convex mirrors.** Convex mirrors are located below the outside flat mirrors. They are used to monitor the left and right sides at a wide angle. They provide a view of traffic, clearances, and students at the side of the bus. These mirrors give a view of people and objects that does not accurately reflect their size and distance from the bus.
4. Convex mirrors give a distorted view that does not accurately reflect size or distance from the bus. You should position your mirrors to see:
 - a. The entire side of the bus up to the mirror mounts;
 - b. Front of the rear tires touching the ground; and
 - c. At least one traffic lane on either side of the bus. [Nevada Commercial Driver Manual](#), (pg. 10-2)

LEFT AND RIGHT SIDE CONVEX MIRRORS

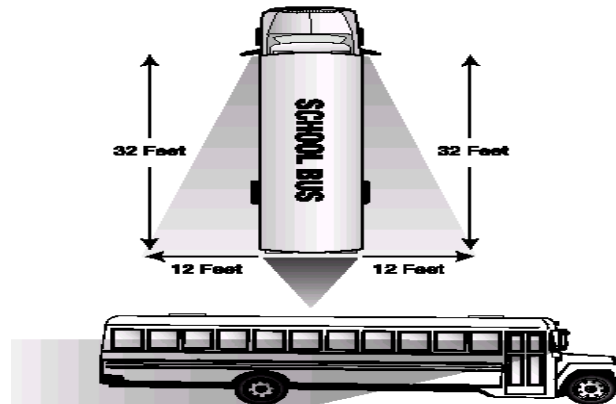

5. **Crossover mirrors.** These mirrors are mounted on both the left and right front corners of the bus. They are used to see the front bumper “danger zone” area directly in front of the bus that is not visible by direct vision, and to view the “danger zone” area to the left and right side of the bus, including the service front wheel area.

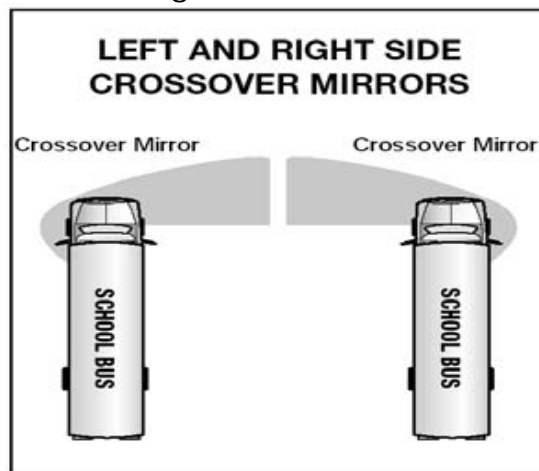

6. Overhead Inside Rearview Mirror

This mirror is mounted directly above the windshield on the driver’s side area of the bus. This mirror is used to monitor passenger activity inside the bus. It may provide limited visibility directly in back of the bus if the bus is equipped with a glass-bottom rear emergency door. There is a blind spot area directly behind the driver’s seat as well as a large blind spot area that begins at the rear bumper and could extend up to 400 feet or more behind the bus. You must use the

exterior side mirrors to monitor traffic that approaches and enters this area.

You should position the mirror to see:

- a. The top of the rear window in the top of the mirror; and
- b. All of the students, including the heads of the students right behind you.



7. Five-Count Mirror Check

Proper mirror use is one of the most important safety factors to safe driving. When checking your mirrors, you need to use the 5-count mirror check. This system of checking your mirrors needs to become automatic. When conducting a 5-count mirror check, start and end on the traffic side.

- a. **Count 1** - Starting on the traffic side, check the mirrors;
 - b. **Count 2** - Check the overhead rear view mirror;
 - c. **Count 3** – Check the opposite mirrors;
 - d. **Count 4** – Check the overhead rear view mirror; and
 - e. **Count 5** – Check the mirrors on the traffic side.
8. Include the front cross-view mirrors anytime students are anywhere near the bus.

When checking mirrors, it is important to move your body (rock back and forth) to help you see in your blind spots.

Developing Good Mirror Use

1. Before starting out from any stop, be sure to check all mirrors, using the 5-count mirror check. Make sure to check for traffic, pupils, (on and off the bus), pedestrians and bicycles – anything! Know what's happening around you before you move.
2. Mirrors are essential to use before and during all turns. Check traffic and back swing clearance before turning.
3. As a school bus driver, you will find that you will be using mirrors more than in your car. The easiest way to learn good mirror use is to set a pattern so it will become habit.

WHEN VEHICLES ARE REQUIRED TO STOP FOR SCHOOL BUSES

Vehicles are required to stop for school buses that are loading and unloading students. A driver must stop at any location for a school bus displaying a flashing red light STOP signal. The driver may not attempt to overtake or proceed past the school bus until the school bus driver has turned off the flashing red stop arm lamps.

There is an exception to this rule; on divided highways, you need to stop only when you are traveling in the same direction as the school bus. [Nevada Driver Handbook](#), (pg. 57)

Nevada law allows school bus drivers to report violations to the school district and the Department of Motor Vehicles. When this occurs, the registered owner of the vehicle will be sent a warning letter explaining the seriousness of the violation. [Nevada Revised Statute 484B.353](#)

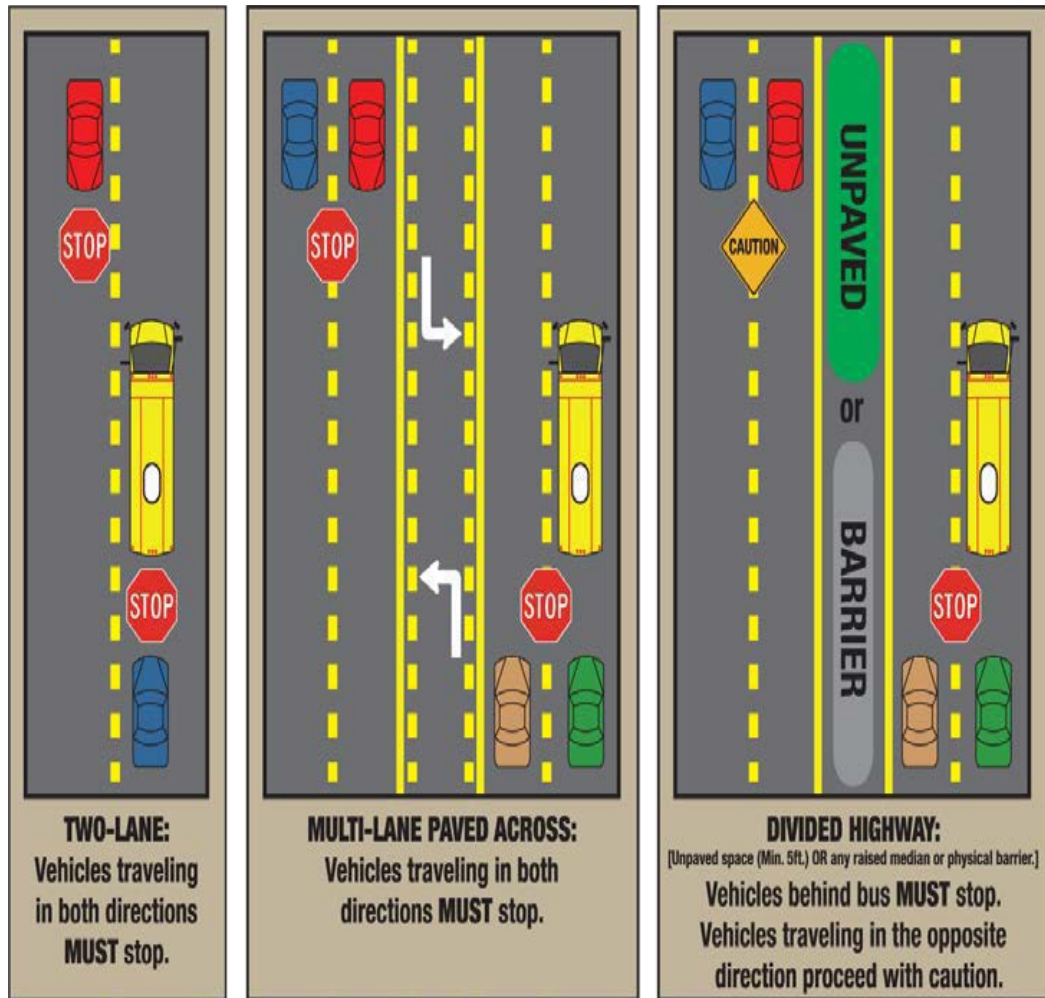

Definition of a Divided Highway

A Divided highway is a highway divided into two or more roadways by a physical barrier or dividing section, constructed so as to impede the conflict of vehicular traffic traveling in opposite directions. [Nevada Revised Statute 484A.070](#)

SECTION 6: HAZARDOUS DRIVING

DISTRACTED DRIVING

Driver distraction is anything that takes your attention away from driving. Whenever you are driving a vehicle and your full attention is not on the task of driving, you are putting yourself, your passengers, other vehicles, and pedestrians in danger. Distracted driving is fast becoming the common cause of collisions, resulting in injury, death or property damage.

1. Activities inside the bus that can distract your attention and include:
 - a. Talking to passengers;
 - b. Adjusting the radio, CD player or Bluetooth connections;
 - c. Climate controls;
 - d. Eating or drinking;
 - e. Picking up something that fell;
 - f. Talking on a cell phone or using a CB radio;
 - g. Reading or sending text messages or using any type of telematics or electronic devices (such as navigation systems, pagers, personal digital assistant, computers or tablets); and
 - h. Daydreaming or other mental distractions.
- [Nevada Commercial Driver License Manual](#), (pg. 2-21)



Effects of Distracted Driving

The effects of distracted driving include slowed perception, which may cause you to be delayed in perceiving or completely fail to perceive an important event; delayed decision making and improper action, which can cause you to be delayed in taking the proper action to make incorrect inputs to the steering, accelerator or brakes.

[Nevada Commercial Driver License Manual](#), (pg. 2-22)

Distracted driving claimed 3,450 lives and injured 391,000 in motor vehicle crashes in 2016 alone.

[National Highway Traffic Safety Administration, Distracted Driving Facts](#)

Types of Distractions

There are many causes of distraction, all with the potential to increase risk.

1. **Physical distraction.** Causes you to take your hands off the wheel or eyes off the road, such as reaching for an object;
2. **Mental distraction.** Are activities that take your mind away from the road, such as engaging in conversation with a passenger or thinking about something that happened during the day; and
3. Both **physical and mental distraction.** An even greater chance of a crash happening.

[Nevada Commercial Driver License Manual](#), (pg. 2-22)

Don't Drive Distracted

1. You need to be able to recognize other drivers who are engaged in any form of driving distraction. Not recognizing other distracted drivers can prevent you from perceiving or reacting correctly in time to prevent a crash. This includes:
 - a. Vehicles that may drift over the lane divider lines or within their own lane;
 - b. Vehicles traveling at inconsistent speeds;
 - c. Drivers who are preoccupied with maps, food, cigarettes, cell

phones, or other objects; and

- d. Drivers who appear to be involved in conversations with their passengers.
2. Give a distracted driver plenty of room and maintain your safe following distance.
 3. Be careful when passing a driver who seems to be distracted. The other driver may not be aware of your presence, and they may drift in front of you.

[Nevada Commercial Driver License Handbook](#), (pg. 2-23)

Operating a CMV includes being temporarily stationary because of traffic, a traffic control device, or other momentary delays.

[Federal Motor Carrier Safety Regulation 395.2, Definitions](#)

COMMUNICATION DEVICES

Two-Way Communication Devices

Two-way communication devices are essential to safety; however, their use is restricted to business purposes and emergencies only.

You are only allowed to use two-way communication devices if you are reporting a medical emergency, a safety hazard or criminal activity or if you are requesting assistance relating to a medical emergency, a safety hazard or criminal activity.

Cell/Mobile Phones/Tablets/Texting

1. The use of cell/mobile phones and tablets have many beneficial uses for the school bus driver, but there are prohibitions and restrictions on the use of these devices. Failure to follow federal and state laws and regulations could result in tickets, fines and termination due to be disqualification to drive a CMV.
2. Federal regulations prohibit a driver from using a hand-held mobile telephone while driving/operating your personal vehicle or a school bus.

Driving is defined as operating a commercial motor vehicle with the motor running, including while temporarily stationary because of traffic, a traffic control device, or other momentary delays.

[Federal Motor Carrier Safety Regulation 392.80, Prohibition Against Texting and 392.82, Using a Hand-Held Mobile Telephone](#)

3. Driving/operating does not include when the driver has moved the vehicle to the side of, or off, a highway, and halted in a location where the vehicle can safely remain stationary.
[Federal Motor Carrier Safety Regulation 392.80, Prohibition Against Texting](#)
4. You are allowed to use your cell phone **ONLY WHEN:**
 - a. Reporting a medical emergency, a safety hazard or criminal activity or if requesting assistance related to a medical emergency, a safety hazard or criminal activity; or
 - b. Responding to a situation requiring immediate action to protect the health, welfare or safety of the driver or another person and stopping vehicle would be inadvisable, impractical or dangerous.
[Nevada Revised Statue 484B.165](#)
5. Nevada law states that you shall not manually type or enter text into a cellular telephone or other handheld wireless communication device, or send or read data using any such devices to access or search the Internet or to engage in non-voice communications with another person, including, without limitation, texting, electronic messaging and instant messaging.
6. Texting while driving (in your vehicle or the school bus) is considered a serious traffic violation. [Nevada Commercial Driver License Manual](#), (pg. 2-22)
7. The provisions of this section do not prohibit the use of a voice-operated global positioning or navigation system that is mounted/affixed to the vehicle. [Nevada Revised Statue 484B.165](#)

8. Texting does not include:

- a. Inputting, selecting, or reading information on a global positioning or navigation system;
- b. Pressing a single button to initiate or terminate a voice communication using a mobile phone; or
- c. Using a device capable of performing multiple functions (e.g. fleet management systems, dispatching devices, smart phones, citizens band radios, etc.).
[Federal Motor Carrier Safety Administration 383.5](#)

HAZARDOUS CONDITIONS

Aggressive Drivers/Road Rage

Aggressive driving and road rage is not a new problem. However, in today's world, where heavy and slow-moving traffic and tight schedules are the norm, more and more drivers are taking out their anger and frustration in their vehicles.

Aggressive driving is the act of operating a motor vehicle in a selfish, bold, or pushy manner, without regard for the rights or safety of others.

Road rage is operating a motor vehicle with the intent of doing harm to others or physically assaulting a driver or their vehicle. [Nevada Commerical Driver Manual](#), (pg. 2-24)

Don't be an Aggressive Driver

1. Reduce your stress before and while you drive. Listening to easy music can help.
2. Give your drive your full attention. Don't allow yourself to become distracted.
3. Be realistic about your drive time. Expect delays because of traffic, construction, or bad weather and make allowances.
4. If you're going to be later than expected, deal with it. Take a deep breath and accept the delay.

5. Give other drivers the benefit of the doubt. Whatever their reason, it has nothing to do with you.
6. Slow down and keep your following distance reasonable.
7. Don't drive slowly in the left lane of traffic.
8. **No gestures!** Keep your hands on the wheel.
9. **Be a cautious and courteous driver.** Don't be offended by other driver's actions.
[Nevada Commercial Driver Manual](#), (pg. 2-24)

What to do When Confronted by an Aggressive Driver

1. First and foremost, make every attempt to get out of their way.
2. Put your pride in the back seat. Do not challenge them by speeding up or attempting to hold-your-own in your travel lane.
3. Avoid eye contact.
4. **Ignore gestures** and refuse to react to them.
[Nevada Commercial Driver Manual](#), (pg. 2-24)

Move-Over Laws

The incidents of law enforcement and emergency medical services, fire department personnel and people working on the road are being struck while performing duties at the roadside are increasing at a frightening pace. Move-over laws have been enacted, which require drivers to slow and change lanes when approaching a roadside incident or emergency vehicle. [Nevada Commercial Driver Manual](#), (pg. 2-18)

When approaching any traffic incident, the driver of the approaching vehicle shall, in the absence of other directions given by a law enforcement officer shall:

1. Decrease your speed;
2. Be prepared to stop;

3. If possible, drive in a lane that is not adjacent to the lane or lanes where the traffic incident is located; and
4. A traffic incident means any vehicle, person, conditions or other traffic hazard which is located on or near a roadway and which poses a danger to the flow of traffic or to a person involved in, responding to or assisting with a traffic hazard. This includes:
 - a. Emergency vehicles;
 - b. Towing vehicles;
 - c. Public Utility vehicles;
 - d. Governmental agencies;
 - e. Vehicles using their flashing warning lights;
 - f. A crash scene;
 - g. A stalled vehicle;
 - h. Debris in the roadway; or
 - i. A person who is out of his or her vehicle attending to a repair.
[Nevada Revised Statue 484B.607](#)

Driving at Night

Driving at night is always more difficult and hazardous than daytime driving. At night you cannot see as far, as soon or as much. The glare from oncoming headlights also adds to the difficulty. Here are some other factors that make night driving dangerous:

1. Driver factors

- a. **Vision.** People cannot see as clearly at night. Your eyes need time to adjust in dim light. Drivers need to have their eyes checked regularly by an eye doctor and wear glasses if required.
- b. **Glare.** Drivers can be blinded by bright light. It can take

several seconds to recover from glare. Even two seconds of glare blindness can be dangerous. Glare from your headlights can cause problems for drivers coming towards you. Dim your lights within 500 feet of an oncoming car.

- c. **Fatigue and lack of alertness.** Fatigue (being tired) can be caused by physical or mental strain, repetitive tasks, illness or lack of sleep. Just like alcohol and drugs, it impairs your vision and judgement.

Fatigue causes errors related to speed and distance, increases your risk of being in a crash, causes you to not see and react to hazards as quickly; and affects your ability to make critical decisions.

- ✓ Drowsy driving is one of the leading causes of traffic collisions. NHTSA estimates 100,000 police-reported crashes a year.
- ✓ According to the National Sleep Foundations Sleep in America Poll, 60% of Americans have driven while feeling sleepy and more than 103 million people admit having actually falling asleep at the wheel.
- ✓ If you are sleepy, the only safe cure is to get off the road and get some sleep.



- 9. **At-risk groups.** Crashes tend to occur at times when sleepiness is most common, like during the night and in the mid-afternoon. Most people are less alert at night, especially after midnight.

Research has identified young males, shift workers, commercial drivers, and people with untreated sleep disorders or with short-term chronic sleep deprivation as having an increased risk for having a crash resulting from falling asleep at the wheel.

NTSB has reported that drowsy driving was the cause of more than half of crashes leading to a death.

[Nevada Commercial Driver Manual](#), (pg. 2-25)

According to the National Sleep Foundation's Sleep in American poll, 60% of Americans have driven while feeling sleepy and 36% admit actually falling asleep at the wheel in the past year.

[Nevada Commercial Driver Manual](#), (pg. 2-

10. **Warning signs of fatigue.** Many people cannot tell if or when they are about to fall asleep. There are warning signs that indicate fatigue:
 - a. Difficulty focusing, frequent blinking or heavy eyelids;
 - b. Yawning repeatedly or rubbing eyes;
 - c. Day-dreaming or wandering/disconnected thoughts;
 - d. Trouble remembering the last few miles driven, missing exits or traffic signs;
 - e. Trouble keeping head up;
 - f. Drifting from your lane, following too closely or hitting a shoulder rumble strip; and
 - g. Feeling restless and irritable.

[Nevada Commercial Driver Manual](#), (pg. 2-25)

11. Roadway Factors

- a. **Poor lighting.** In the daytime there is usually enough light to see well. That is not true at night. Some areas may have bright street lights, but many areas will have poor lighting. On most

roads you will probably have to depend entirely on your headlights.

Less light means you will not be able to see hazards as well as in the daytime. There are many crashes at night involving pedestrians, joggers, bicyclists, and animals.

- b. **Traffic signals** and hazards can be hard to see against a background of signs, shop windows, and other lights.
- c. **Drunk drivers** and drivers under the influence of drugs are a hazard to themselves and to you. Be especially alert around bars and taverns. Watch for drivers who have trouble staying in their lane or maintaining speed, stop without reason, or show others signs of being under the influence.
[Nevada Commercial Driver Manual](#), (pg. 2-27)

12. Vehicle Factors

- a. At night your headlights will usually be the main source of light for you to see and for others to see you. You can't see nearly as much with your headlights as you can see in the daytime. With low beams you can see 350-500 feet. You must adjust your speed to keep your stopping distance within your sight distance. This means going slowly enough to be able to stop within the range of your headlights.
- b. Dirty headlights may give only half the light they should. This cuts down on your ability to see, and makes it harder for other to see you.
- c. Other lights. In order for you to be seen easily, the following must be clean and working properly. This includes:
 - ✓ Reflectors;
 - ✓ Marker lights;
 - ✓ Clearance lights;
 - ✓ Taillights;
 - ✓ Identification lights;

- ✓ Turn signals and brake lights;
 - ✓ Hazard lights; and
 - ✓ Brake lights.
- d. Windshields and mirrors must be clean. Bright lights at night can cause dirt on your windshield or mirrors to create glare of its own.
- e. Avoid blinding others. Glare from your headlights can cause problems for drivers coming toward you. They can also bother drivers going in the same direction you are, when your lights shine in their rearview mirrors. Dim your lights within 500 feet of an oncoming vehicle and when following another vehicle within 500 feet.
- f. Avoid glare from oncoming vehicles. Do not look directly at lights of oncoming vehicles. Look slightly to the right at a right lane or edge marking, if available. If other drivers don't put their low beams on, don't try to "get back at them" by putting your own high beams on.
- g. Use high beams when you can. Some drivers make the mistake of always using low beams. This seriously cuts down on their ability to see ahead. Use high beams when it's safe and legal to do so. Use them when you are not within 500 feet of an approaching vehicle. Also, don't let the inside of your vehicle get too bright. This makes it harder to see outside. Keep the interior light off, and adjust your instrument lights as low as you can to still be able to read the gauges.
[Nevada Commercial Driver Manual](#), (pg. 2-27)

Driving in Fog

Fog can occur at any time. Fog on highways can be extremely dangerous. Fog is often unexpected, and visibility can deteriorate rapidly. The best advice for driving in fog is DON'T! It is preferable that you pull off the road until visibility is better.

If your windows fog up, in addition to the defroster/fans, turn on your AC or open a window.

1. If you must drive in fog, be sure to do the following:
 - a. Slow down before you enter fog;
 - b. Use low-beam headlights and fog lights for best visibility even in daytime and be alert for other drivers who may have forgotten to turn on their lights;
 - c. Turn on your 4-way flashers. This will give vehicles behind you a quicker opportunity to notice your vehicle;
 - d. Watch for vehicles on the side of the roadway. Seeing taillights or headlights in front of you may not be a true indication of where the road is ahead of you. The vehicle may not be on the road at all;
 - e. Use roadside highway reflectors as guides to determine how the road may curve ahead of you;
 - f. Listen for traffic you cannot see;
 - g. Don't pass other vehicles;
 - h. Don't stop along the side of the road, unless absolutely necessary; and
 - i. USE the strobe light, if your bus is equipped with one. [Nevada Commercial Driver Manual](#), (pg.10-10, pg. 2-27)

Driving in Winter

When driving in winter, you need to pay extra attention to the following issues.

1. **Slippery surfaces.** Drive slowly and smoothly on slippery roads. If it is very slippery, you shouldn't drive at all. Stop at the first safe place. If driving on slippery surfaces, you should:

- a. **Start gently and slowly.** When first starting, get the feel of the road. Don't hurry.
- b. **Check for ice.** Check for ice on the road, especially bridges and overpasses. A lack of spray from other vehicles indicates ice has formed on the road. Also, check your mirrors and wiper blades for ice.
- c. **Adjust turning and braking to conditions.** Make turns as gently as possible. Do not brake any harder than necessary, and don't use the engine brake or speed retarder (They can cause the driving wheels to skid on slippery surfaces).
- d. **Adjust speed to conditions.** Don't pass slower vehicles unless necessary. Go slow and watch far enough ahead to keep a steady speed. Avoid having to slow down and speed up. Take curves at slower speeds and don't brake while in curves. Be aware that as the temperature rises to the point where ice begins to melt, the road becomes even more slippery. Slow down more.
- e. **Adjust space to conditions.** Don't drive alongside other vehicles. Keep a longer following distance. When you see a traffic jam ahead, slow down or stop to wait for it to clear. Try hard to anticipate stops early and slow down gradually.



- 2. **Wet brakes.** When driving in heavy rain or deep standing water, your brakes will get wet. Water in the brakes can cause the brakes to be weak, to apply unevenly, or to grab. This can cause lack of braking power, wheel lockups, pulling to one side or the other.
- 3. Avoid driving through deep puddles or flowing water if possible. But if you cannot, you should:

- a. Slow down and place transmission in a low gear;
- b. Gently put on the brakes. This presses linings against brake drums or discs and keeps mud, silt, sand, and water from getting in;
- c. Increase engine rpm and cross the water while keeping light pressure on the brakes;
- d. When out of the water, maintain light pressure on the brakes for a short distance to heat them up and dry them out; and
- e. Make a test stop when safe to do so. Check behind to make sure no one is following, and then apply the brakes to be sure they work right. If not, dry out further as described above.
- f. **CAUTION:** Do not apply too much brake pressure and accelerator at the same time or you can overheat brake drums and linings.

[Nevada Commercial Driver Manual](#), (pg. 2-29)



4. **Ice and snow equipment.** You may be required to put chains on your bus when there is ice and snow on the ground. The maximum speed while driving with chains on is 30 mph.

5. Snow chains

- a. Automatic Chains are activated by a switch in the driver area and should be activated and deactivated when the bus is in motion at about 25-30 mph (this prevents damage to the chains).
- b. Automatic chains don't work in deep snow and should be deactivated as soon as they are not needed.

- c. Manually installed chains consist of 2 circular metal loops, one tire, which is connected by evenly spaced chains across the tire tread. There are three types of chain clamps:
 - ✓ Type 1-Chain with S-hook;
 - ✓ Type 2-Cam locks; or
 - ✓ Type 3-Cable Chains.
6. To install manual chains, you will need to follow manufacturer and your trainer instructions.
7. Tightener's are larger rubber bands that resemble a bungee cord and take up slack in the chains and have 5 to 8 hooks that hook onto the chain links.



Driving in High Winds

Strong winds affect the handling of the school bus. The side of a school bus acts like a sail on a sailboat. Strong winds can push the school bus sideways. They can even move the school bus off the road or, in extreme conditions, tip it over.

Your school district will monitor and notify drivers if a road has been closed due to high winds or other conditions.

[Nevada Department of Transportation Road Conditions](#)

If you are caught in strong winds:

1. Keep a strong grip on the steering wheel. Try to anticipate gusts;

2. Slow down to lessen the effect of the wind, or pull off the roadway and wait; and
3. Contact your dispatcher to get more information on how to proceed. [Nevada Commercial Driver Manual](#), (pg. 10-11)

Driving in Hot Weather

When driving in hot weather, you need to pay special attention to:

1. **Tires.** Check the tire mounting and air pressure. Inspect the tires every 2 hours or 100 miles when driving in very hot weather. Air pressure increases with temperature. Do not let air out or the pressure will be too low when the tires cool off. If a tire is too hot to touch, remain stopped until the tire cools off. Otherwise the tire may blow out or catch fire.
2. **Engine oil.** The engine oil helps keep the engine cool, as well as lubricating it. Make sure there is enough engine oil. Continually check the oil temperature gauge to make sure the temperature is within proper range while you are driving.
3. **Engine coolant.** Before starting out, make sure that the engine cooling system has enough water and antifreeze. When driving, check the water temperature and coolant temperature gauge from time to time. Make sure it remains in the normal range. If the gauge goes above the highest safe temperature, there may be something wrong that could lead to engine failure and possibly fire.

Some vehicles have sight glasses, see-through coolant overflow containers or coolant recovery containers. These permit you to check the coolant level while the engine is hot. If the container is not part of the pressurized system, the cap can be safely removed and coolant added even when the engine is at operating temperatures. **Never remove the radiator cap or any part of the pressurized system until the system is cooled!** Steam and boiling water can spray under pressure and cause severe burns. If you can touch the radiator cap with your bare hand, it is probably cool enough to open.



4. **Engine belts.** Learn how to check belt tightness on your bus by pressing on the belts. Loose belts will not turn the water pump and/or fan properly. This will result in overheating. Also check the belts for cracking or other signs of wear. Check for tension or movement.
5. **Hoses.** Make sure coolant hoses are in good condition. A broken hose while driving can lead to engine failure and even fire.
6. **Bleeding tar.** Tar in the road pavement frequently rises to the surface in very hot weather. Spots where tar “bleeds” to the surface are very slippery.
7. Go slow enough to prevent overheating. High speeds create more heat for tires and the engine. In desert conditions the heat may build up to the point where it is dangerous. The heat will increase chances of tire failure or even fire, and engine failure.
[Nevada Commercial Driver Manual](#), (pg. 2-27)

Driving in Mountains

In mountain driving, gravity plays a major role. On any upgrade, gravity slows you down. The steeper and/or longer the grade and/or the heavier the load, the more you will need to use lower gears to climb hills or mountains. When driving in mountains, you must do the following:

1. When coming down, long steep downgrades, gravity causes the speed of your vehicle to increase. You must select an appropriate **Safe Speed**, then use a lower gear, and use proper braking techniques.
2. **Go slow.** This is so your brakes can hold you back without getting too hot. If the brakes become too hot, they may start to fade or glaze. This means you have to apply them harder and harder to get the same stopping power.

3. **Select a safe speed.** The most important consideration is to select a speed that is not too fast for the hill. Your **safe speed** includes:
 - a. Total weight of the vehicle and students;
 - b. Length of grade;
 - c. Steepness of the grade;
 - d. Road conditions; and
 - e. Weather.
4. If a speed limit is posted, or there is a sign indicating Maximum Safe Speed, never exceed the speed shown. Also, look for and heed warning signs indicating the length and steepness of the grade.
5. You must use the braking effect of the engine as the principal way of controlling your speed. The braking effect of the engine is greatest when it is near the governed rpms and the transmission is in the lower gears. Save your brakes so you will be able to slow or stop as required by road and traffic conditions.
6. **Be in the right gear before starting down the grade.** Shift the transmission to a lower gear before starting down the grade. Do not try to downshift after your speed has already built up. You will not be able to get back into any gear and all engine braking affect will be lost. Forcing an automatic transmission into a lower gear at high speed could damage the transmission and lead to loss of all engine braking affect.
7. **Brake fading or failure.** Brakes can fail from excessive heat caused by using them too much and not relying on the engine braking effect. Use proper braking techniques on a long or steep downgrade:
 - a. Apply the brakes just hard enough to feel a definite slowdown;
 - b. When your speed has been reduced to approximately five mph below your safe speed, release the brakes. This brake application should last for about 3 seconds;
 - c. When your speed has increased to your safe speed, repeat steps 1 and 2; and

- d. Escape ramps have been built on many steep mountain downgrades. Escape ramps are a long bed of loose soft material to slow a runaway vehicle.
[Nevada Commercial Driver Manual](#), (pg. 2-33)

**You may be ticketed for improper use
of an escape ramp.**

- 8. **Slow moving school buses.** When traveling on a mountain road that has one lane for traveling in each direction AND where passing is unsafe, the driver of a slow-moving school bus (defined as a vehicle traveling at a rate of speed less than the posted speed limit) shall do the following when five or more vehicles have formed a line behind the bus:
 - a. At the nearest place designated as a turnout by signs erected by the public authority.
 - b. In the absence of such a designated turnout, at the nearest place where:
 - ✓ Sufficient area for a safe turnout exists; and
 - ✓ The circumstances and conditions are such that the driver is able to turn off the roadway in a safe manner.
[Nevada Revised Statue 484B.630](#)

TAIL SWING

A school bus can have up to a three-foot tail swing. You need to check your mirrors before and during any turning movements to monitor the tail swing. [Nevada Commercial Driver Manual](#), (pg. 10-11)

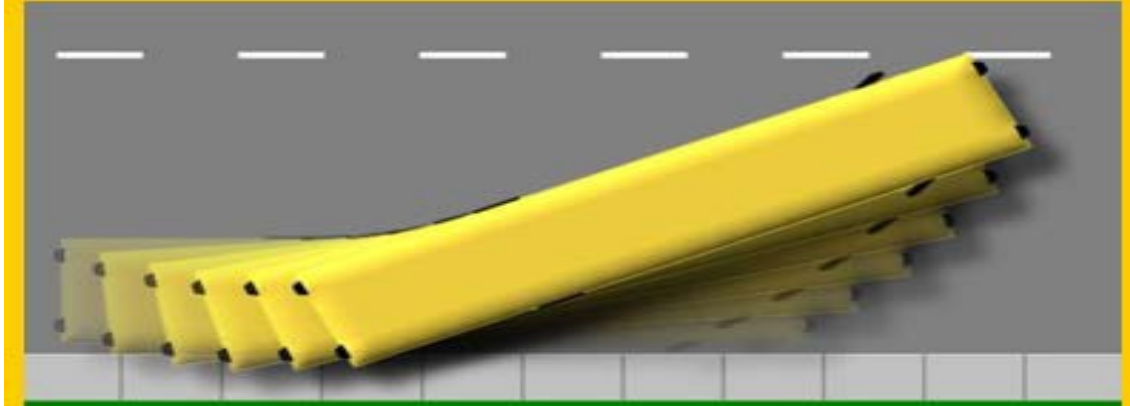

DEFENSIVE DRIVING

Steering to Avoid a Crash

Following safe driving practices can prevent emergencies, but if an emergency does happen, your chances of avoiding a crash depend upon how well you take action.

Stopping is not always the safest thing to do in an emergency. When you don't have enough room to stop, you may need to steer away from what's ahead. Remember, you can almost always turn to miss an obstacle more quickly than you can stop.

1. **Keep both hands on the steering wheel.** In order to turn quickly you must have a firm grip on the steering wheel with both hands. The best way to have both hands on the wheel in the event of an emergency is to keep them there all the time.
2. **Know how to turn quickly and safely.** A quick turn can be made safely, if it is done the right way. Here are some points that safe drivers use.
 - a. **Do not apply the brake** while you are turning. It is very easy to lock your wheels while turning. If that happens, you may skid out of control.
 - b. **Do not turn any more than needed** to clear whatever is in your way. The more sharply you turn, the greater the chances of a skid or rollover.
 - c. **Be prepared to counter-steer**, that is, to turn the wheel

back in the other direction, once you have passed whatever was in your path. Unless you are prepared to counter-steer, you won't be able to do it quickly enough. You should think of emergency steering and counter-steering as two parts of one driving action.

[Nevada Commercial Driver Manual](#), (pg. 2-36)

**If you have to steer to avoid
crash, DON'T BRAKE!**

3. **Know where to steer.** If an oncoming driver has drifted into your lane, moving to the right is best. If that driver realizes what has happened, the natural response will be to return to his or her own lane.
4. If something is blocking your path, the best direction to steer will depend on the situation.
 - a. If you have been using your mirrors, you'll know which lane is empty and can be safely used.
 - b. If the shoulder is clear, going right may be best. No one is likely to be driving on the shoulder but someone may be passing you on the left. You will know if you have been using your mirrors.
 - c. If you are blocked on both sides, a move to the right may be best. At least you won't force anyone into an opposing traffic lane and a possible head-on collision.
5. **Leaving the road.** In some emergencies, you may have to drive off the road. It may be less risky than facing a collision with another vehicle.
6. Most shoulders are strong enough to support the weight of a large vehicle and, therefore, may offer an available escape route. Here are some guidelines to follow if you do leave the road.
 - a. Avoid braking. If possible, avoid using the brakes until your speed has dropped to about 20 mph. Then brake very gently to avoid skidding on a loose surface.

- b. Keep one set of wheels on the pavement if possible. This will help maintain control.
 - c. Stay on the shoulder. If the shoulder is clear, stay on it until your vehicle has come to a stop.
7. **Returning to the road.** If you are forced to return to the road before you can stop, do the following.
- a. Hold the wheel tightly and turn enough to get right back on the road safely. Try to edge gradually back on the road. If you do, your tires might grab unexpectedly and you could lose control.
 - b. When both front tires are on the paved surface, counter steer immediately. The two turns should be made as a single steer-counter steer move.
[Nevada Commercial Driver Manual](#), (pg. 2-32)

Stopping Quickly and Safely

If someone suddenly pulls out in front of you, your natural response is to hit the brakes. This is a good response if there's enough distance to stop and you use the brakes correctly.

You should brake in a way that will keep your vehicle in a straight line and allow you to turn if it becomes necessary. You can use either the controlled braking or the emergency stab braking method.

1. **Controlled braking.** Apply the brakes as hard as you can without locking the wheels. Keep steering wheel movements very small while doing this. If the wheels lock, release the brakes. Re-apply the brakes as soon as you can.
2. **Emergency stab braking**
 - a. Apply your brakes all the way.
 - b. Release the brakes when wheels lock up.
 - c. Once the wheels start rolling, apply the brakes fully again. (It can take up to 1 second for the wheels to start rolling after you release the brakes. If you re- apply the brakes before the wheels start rolling, the vehicle won't straighten out.

- d. Hold the wheel tightly and turn enough to get right back on the road safely. Try to edge gradually back on the road. If you do, your tires might grab unexpectedly and you could lose control.
- e. Do not jam the brakes. Emergency braking does not mean pushing down on the brake pedal as hard as you can. That will only keep the wheels locked up and cause a skid. If the wheels are skidding, you cannot control the vehicle.
[Nevada Commercial Driver Manual](#), (pg. 2-32)

Brake Failure

Brakes kept in good condition rarely fail. Most hydraulic brake failures occur for one of two reasons: Loss of hydraulic pressure and brake fade on long hills. If you lose air/hydraulic Pressure:

1. Pump the brakes (for hydraulic brakes only);
2. Downshift;
3. Pump the brakes;
4. Use the parking brake;
5. Use an escape ramp; and
6. If no escape ramp is available, take the least hazardous escape route you can-such as an open field or a side road that flattens out or turns uphill.
[Nevada Commercial Driver Manual](#), (pg. 2-33)

Proper Braking Technique

When driving downhill, snub braking is an effective braking technique. You need to select a safe speed, which is a speed that does not exceed the speed limit, is not too fast for the weight of the vehicle, length and steepness of the grade, weather and road conditions. Once you reach your safe speed, brake down gently to 5 mph below your safe speed. Brake for a firm 3-4 seconds followed by a gradual cooling. Continue this procedure while driving downhill to maintain your safe speed.
[Nevada Commercial Driver Manual](#), (pg. 5-9)

If you have tire failure, do not brake until after you have gained control of the bus!

Tire Failure

It is important that you recognize tire failure quickly because you only have a few seconds to react. If your front tire has a blowout, your bus will pull in the direction of the flat. If your rear tire blows out, the bus will swerve violently. Here is how to recognize tire failure.

1. **Sound.** The loud bang of a blowout is an easily recognized sign. Because it can take a few seconds for your vehicle to react, you might think it is some other vehicle. But any time you hear a tire blow, you must assume it is yours and prepare to stop.
2. **Vibration.** If the vehicle thumps or vibrates heavily, it may be a sign that one of the tires has gone flat. With a rear tire, that may be the only sign you get.
3. **Feel.** If the steering feels heavy, it is probably a sign that one of the front tires has failed. Sometimes, failure of a rear tire will cause the vehicle to slide back and forth or fishtail. However, dual rear tires usually prevent this.
4. If you believe that one of your tires has had a blowout, you need to:
 - a. **Hold the steering wheel firmly.** If a front tire fails, it can twist the steering wheel out of your hand. The only way to prevent this is to keep a firm grip on the steering wheel with both hands at all times.
 - b. **Stay off the brake.** It's natural to want to brake in an emergency. However, braking when a tire has failed could cause you to lose of control.
[Nevada Commercial Driver Manual](#), (pg. 2-33)
 - c. Once you have regained control, use steady braking, making sure to not lock up the wheels.
 - d. Move off the roadway as far as possible and secure the bus.

- e. Notify your dispatcher and evacuate the bus if necessary.

RAILROAD CROSSINGS

In 2017 there were 2,105 highway-rail grade crossing collisions, 274 fatalities and 807 injuries. [Operation Lifesaver Data](#)

Decide Smart, Arrive Safe

Signs & Signals at Railroad Crossings

1. **Passive and active traffic control** signs. These devices are installed along the roads near the railroad tracks to regulate, warn and guide traffic. They alert you to the presence of railroad tracks and to the possibility of an approaching train. Below is a list of various signs and devices that you will see in connection with a highway-rail grade crossing.
2. The **Crossbuck** sign is the most common sign at public highway-rail intersections. It has two crossed white boards with words railroad crossing. It marks the crossing.
 - a. If there is more than one track, a sign below the cross buck indicates the number of tracks present.
 - b. School buses must stop before the crossbuck sign.
 - c. After a train has passed, wait look and listen for another train coming from either direction. Take care at passive crossings.

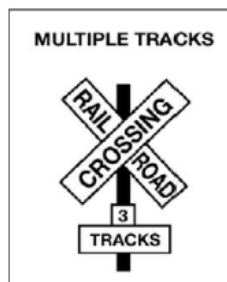

3. The **stop** and **yield** sign means the same as they do at highway intersections. A driver must always stop at the STOP sign in advance of the railroad track.

School bus drivers are required to STOP at railroad crossings when transporting students.

[Nevada Revised Statute 484B.560](#)

4. The **do not stop on the tracks** sign reminds the driver not to stop on the railroad track for any reason.



5. The **tracks out of service** sign tells the driver trains no longer travel these tracks. It is not necessary to stop at these crossings.



6. The **exempt** crossing sign placed below the cross buck informs drivers of school buses carrying children that a stop is not required by law, **except** when a train is approaching or occupying the crossing.
7. Because these tracks can be activated and trains could be on the tracks, it is recommended that exempt stops be evaluated and school bus drivers use extreme caution when approaching **exempt** crossings. Some school districts may require school buses stop at exempt crossings.

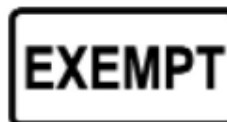

8. **Signs in advance** of railroad crossings warn drivers that the road crosses the railroad tracks ahead.

9. Yellow circular **advance warning** sign warns drivers that the road crosses railroad tracks ahead.



10. **Pavement markings** on paved roads near the yellow circular Advance Warning sign also alert drivers that the road crosses railroad tracks ahead.



11. A **stop line** may be painted across the lane on paved roads and identifies the safe place to stop while looking and listening for an approaching train.
12. The driver must stop the school bus before the Stop Line. On gravel roads there are no pavement markings or stop lines. If there are no Stop Line, you must stop the school bus within 50 feet but not less than 15 feet from the nearest rail. [Nevada Revised Statute 484B.553](#)
13. The Stop Line on each side of a single track grade crossing are at least 35 feet apart. Do not stop within this area.
14. Drivers should remember to apply the emergency or parking brakes while waiting at the Stop Line so they won't move or be shoved into the path of the train.

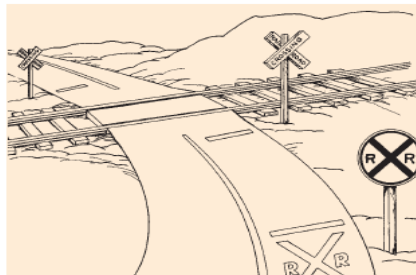

15. The **yellow diamond parallel track** sign identifies highway-rail grade crossings that appear immediately after making either a right or a left turn.

[Operation Lifesaver School Bus Driver's Guide](#)



Active Signal Devices at Railroad Crossings

There are electronically powered devices that warn of an approaching train.

1. **Flashing red lights**, with or without bells-warn of an approaching train. When the red lights are flashing, a train is approaching. You must stop and wait until the train passes, the gates go up and the lights go out, and then proceed when it is clearly safe to do so.
2. Flashing red lights, with bells and gates-warn that a train is approaching. It is illegal to go around lowered gates.

[Operation Lifesaver Instructors Guide](#)

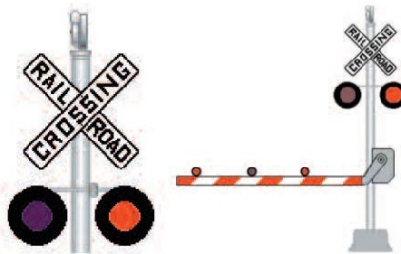

3. **Emergency notification** sign shows the railroad's emergency phone number and USDOT Crossing Number. Each crossing in the USA has a unique USDOT Crossing Number. If it is missing call 911.



4. When you are not required to stop at a railroad crossing.

- a. When you are not carrying students on the school bus.
- b. When a police officer or official traffic-control device controls the movement of traffic.
- c. When the crossing that is marked with a device indicating that the crossing is abandoned or exempt.

[Federal Motor Carrier Safety Regulation 392.10](#) and [Nevada Revised Statute 484B.560](#)

NEVER attempt to race a train to a crossing. It is easy to misjudge a train's speed and distance, making it appear to be moving more slowly than it actually is.

PROCEDURES FOR CROSSING RAILROAD TRACKS

Approaching the Crossing

1. Scan your surroundings and check for traffic in all directions using a five-count mirror check.
2. Activate your turn signal 100 feet in residential and 300 feet on a highway and get into the right lane far in advance of the stop. You must be on the traveled part of the roadway, not the shoulder.
3. Slow down and test your brakes.
4. Activate your four-way hazard lights approximately 200 feet before the crossing. Make sure your intentions are known.
5. Scan your surroundings and check for traffic in all directions using a five-count mirror check.
6. Stay to the right of the road without leaving the paved road.
7. Choose an escape route in the event of a brake failure or problems

behind you.

8. Scan your surroundings and check for traffic in all directions using a five-count mirror check.

[Nevada Commercial Driver License Manual](#), (pg. 10-7)



At the Crossing

1. Bring the bus to a full and complete stop no less than 15 feet and no more than 50 feet from the nearest rail, where you have the best view of the tracks;
2. Place the transmission in Park, or if there is no Park shift point, in Neutral and press down on service brake or set the parking brake.
3. Turn off all radios and noisy equipment and silence your students.
4. Open the service door and driver's window. Look and listen in both directions for an approaching train; and

[Nevada Commercial Driver License Manual](#), (pg. 10-9)

5. Check beyond the track or tracks for traffic congestion, a signal or STOP sign. It is illegal for any vehicle to fail to completely cross the track or tracks without stopping due to insufficient:
 - a. Space for the vehicle on the opposite side of the railroad crossing; or
 - b. Undercarriage clearance of the vehicle. Completely cross means to travel across a railroad track or tracks in such a manner that the trailing end of the bus is 15 feet or more past the nearest railroad track.

[Nevada Revised Statute 484B.560](#)



Crossing the Track

1. Check the crossing signals again before proceeding;
2. Assure you can completely cross (end of bus is 15 feet or more past the nearest rail of the railroad tracks) the track or tracks without stopping due to insufficient:
 - a. Space for the vehicle on the opposite side of the railroad crossing; or
 - b. Undercarriage clearance of the bus.
[Nevada Revised Statue 484B.560](#)
3. At a multiple-track crossing, stop **ONLY** before the first set of tracks. When you are sure no train is approaching on any track, proceed across all of the tracks until you have completely cleared them.
4. Release the transmission or parking brake.
5. Close the door. Continue to **look** and **listen** for an approaching train.
6. Cross the tracks in a low gear as quickly as possible. Do not change gears.
7. Never permit traffic conditions to trap you in a position where you have to stop on the tracks. Be sure you can get all the way across the tracks before you start across.
8. Turn off your hazard lights, deactivate the noise shutoff switch, and activate the master switch.

9. If the gate comes down after you have started across, drive through it even if it means you will break the gate.

[Nevada Commercial Driver License Manual](#), (pg. 10-7)



Special Situations at Railroad Crossings

1. **Bus stalls or trapped on tracks.** If your school bus stalls or is trapped on the tracks, get everyone out and off the bus and tracks immediately. Move everyone far from the bus at an angle, which is both away from the tracks and toward the train.
2. **Police officer at the crossing.** If a police officer is at the crossing, obey directions. If there is no police officer, and you believe the signal is malfunctioning, call your dispatcher to report the situation and ask for instructions on how to proceed.
3. **Obstructed view of tracks.** Do not attempt to cross the tracks unless you can see far enough down the track to know for certain that no trains are approaching.
4. **Passive crossings.** Are those that do not have any type of traffic control device. Be especially careful at "passive" crossings. Even if there are active railroad signals that indicate the tracks are clear, you must look and listen to be sure it is safe to proceed.
5. **Containment or storage areas.** If it won't fit, don't commit! Each driver needs to know the length of their bus and the size of the storage or containment area at the highway-rail crossings on your school bus route, as well as any crossing you encounter in the course of a school activity trip.
6. When approaching a crossing with a signal or stop sign on the opposite side, pay attention to the amount of room there. Be certain

the bus has enough containment or storage area to completely clear the railroad tracks on the other side if there is a need to stop. As a general rule, add 15 feet to the length of the school bus to determine an acceptable amount of containment or storage area.

[Nevada Commercial Driver License Manual](#), (pg. 1-9)

7. Watch your overhang. Know the length of your vehicle and allow for your vehicle's overhang as well. While the wheels of the bus may have crossed the track, many drivers don't realize that their back end could still be hanging over the tracks. Many times a crash could be avoided if it weren't for the last few feet.

[Operation Lifesaver Instructor Guide](#)



Mandatory Emergency Evacuations at Railroad Crossings

You are required to evacuate the school bus when:

1. Your school bus is stalled on or adjacent to a railroad crossing; or
2. The position of the bus may change and increase danger.

[Nevada Commercial Driver License Manual](#), (pg. 10-6)

Requirements to Practice Emergency Evacuation Drills

1. At least twice each year, all students who ride the school bus must practice the evacuation of a school bus and receive instruction in the responsibility of a passenger on a school bus to use the emergency exit doors on the school bus, including helping passengers evacuate the school bus in an emergency.
2. Each school district shall adopt a safety program in accordance with

[NRS 386.820 Section 2](#)

3. You must practice and participate in emergency evacuations at the beginning of any field trip.
[Nevada Revised Statute 386.820](#) and [National Transportation Safety Board Safety Recommendation, Oakland Iowa](#)

Evacuation Procedures

1. **Be prepared and plan ahead.** When possible, assign two responsible, older student assistants to each emergency exit. Teach them how to assist other students to get off the bus and how to use emergency exits and equipment. If an emergency evacuation is required, you must scan your surroundings and check for traffic in front and behind you. Know the safest location to take your students in event of a crisis at any crossing on your route.
3. Plan how you would evacuate your bus to a safe place as far away from the railroad tracks at least 100 feet off the road in the direction of an oncoming train.
4. Place transmission in Park, set the parking brake and shut the engine off.
5. Remove the ignition key and activate the hazard-warning lights;
6. Order the evacuation and get the students off the bus quickly to a safe place. Make sure to walk through the bus to ensure no students remain on the bus. Retrieve emergency equipment.
7. If necessary, call 911. Notify dispatch of evacuation location, conditions, and type of assistance needed. Use the emergency notification number posted at or near the crossing to notify them that you're stalled on the tracks and call 911.
8. Account for all students and check for their safety.
9. Protect the scene and set out emergency warning devices.
[Nevada Commercial Driver License Manual](#), (pg. 10-7)

Disqualification for Railroad-Highway Crossing Violations

1. A driver will be disqualified if convicted of a violation of a railroad highway grade crossing. You will lose your CDL:

- a. For at least 60 days for your first violation.
 - b. For at least 120 days for your second violation within a three- year period.
 - c. For at least one year for your third violation within a three- year period.
- [Nevada Commercial Driver License Manual](#), (Pg. 1-5)

SECTION 7: LOADING AND UNLOADING ZONE

DANGER ZONE

The loading and unloading zone around the school bus is the most dangerous spot for children. Fatalities continue to occur at and around the bus stop.

The area surrounding the school bus is known as the **Danger Zone** because it is the area where children are in the most danger of being hit, either by another vehicle or their own bus. Although there is no federally mandated danger zone, in Nevada the danger zone is defined as extending **at least 10 feet around the bus**.

The danger zone is the area on all sides of the bus where **children are in the most danger** of being hit, either by another vehicle or the school bus. The danger zones may extend as much as **30 feet** from the front bumper with the first **10 feet** being the most dangerous, **10 feet** from the left and right sides of the bus and **10 feet** behind the rear bumper of the school bus. In addition, the area to the left of the bus is always considered dangerous because of passing cars.

[Nevada Commercial Driver License Manual](#), (pg. 10-1)

As a school bus driver, it is your responsibility to educate your students of the dangers surrounding the bus and where it is safe for them to walk. You will have to constantly remind your students, especially the young and handicapped children.

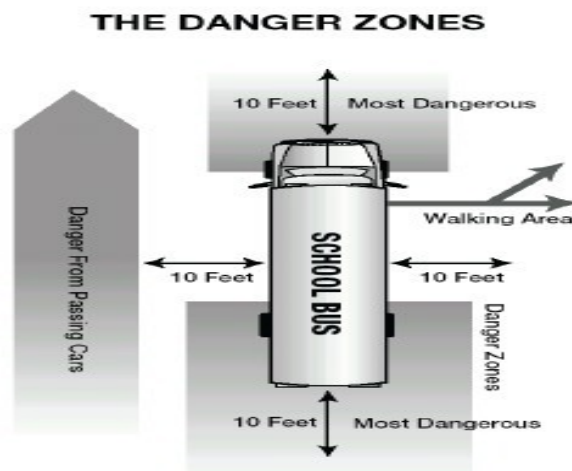

The **danger zone** extends as much as **30 feet** from the front bumper with the first **10 feet** being the most dangerous.

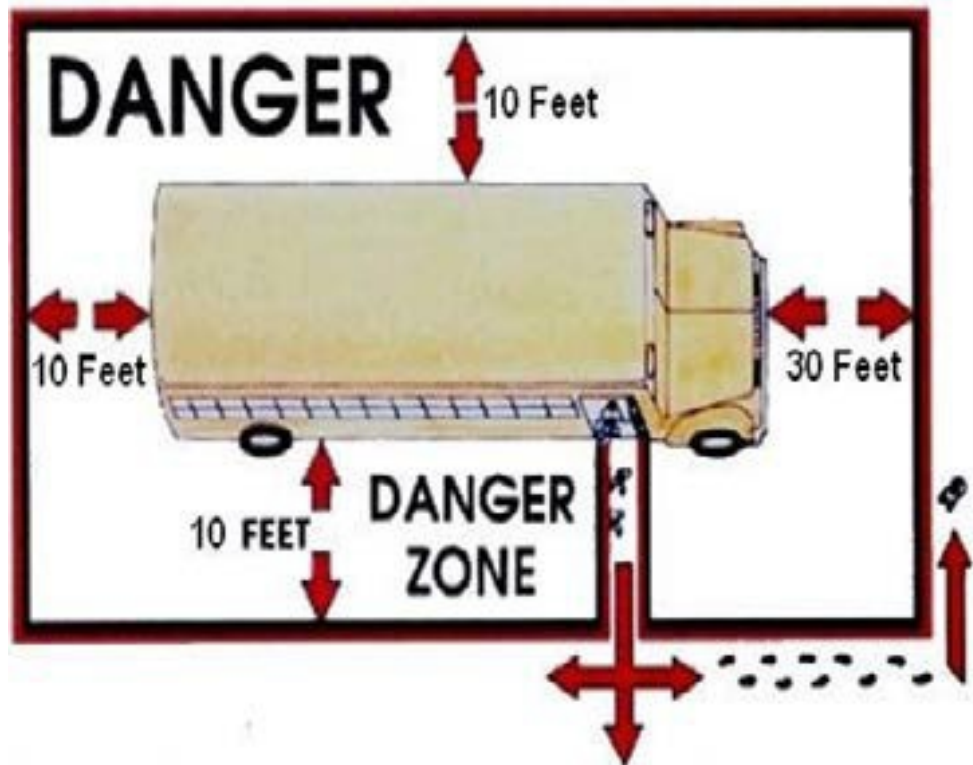

THE LOADING AND UNLOADING ZONE

Loading and unloading students is the most dangerous time for school bus drivers and students.

More students are killed while getting on or off a school bus each year than are killed as passengers inside of a school bus. As a result, knowing what to do before, during, and after loading or unloading students is critical.

[Nevada Commercial Driver License Manual](#), (pg. 10-3)

In the school year 2016-2017 there were 8 fatalities in the loading and unloading zone.

REPORTS OF FATALITIES BY STATE 2016-2017

DRAFT

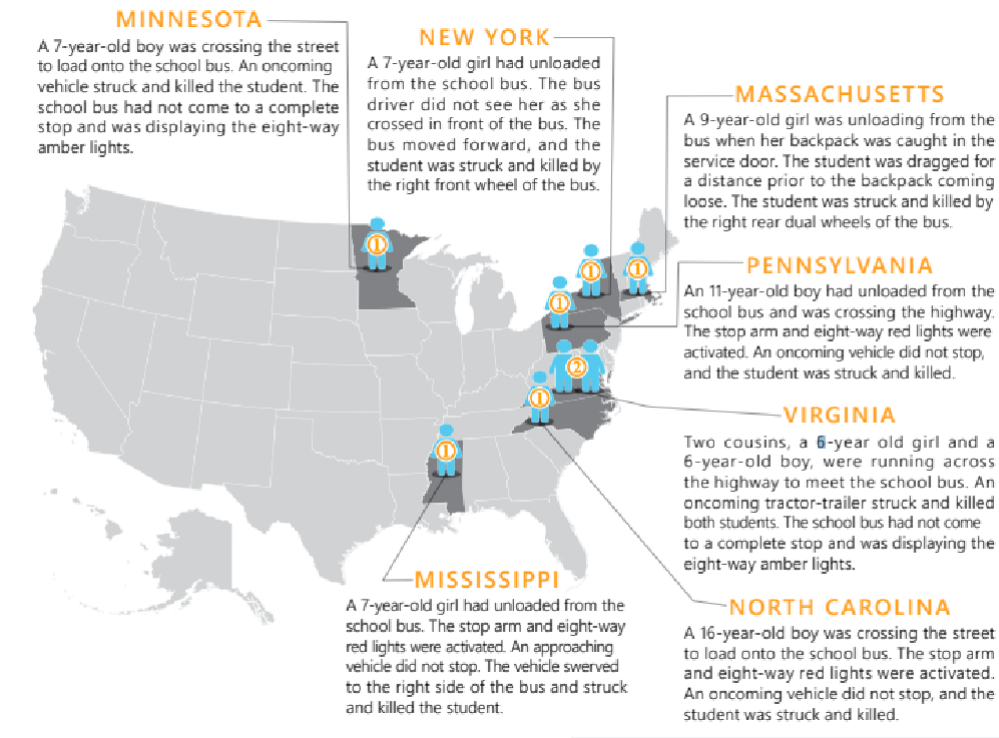

ILLEGAL PASSING OF THE SCHOOL BUS

School buses have a system of yellow/amber lights to warn motorists that the school bus is getting ready to stop to load or unload children. Illegal passing of a stopped school bus is one of the biggest problems school bus drivers encounter.

Illegal Passing Statistics

Illegal passing of school buses continues to be a significant danger for students. The National Association of State Directors of Pupil Transportation Services (NASDPTS) has been requesting school bus drivers across the country count the number of vehicles that illegally passed their school bus on a single day.

In 2018, 39 states reported 106,383 drivers who illegally passed a stopped school bus. With only about 20% of school bus drivers reporting nationally, it is estimated that there are over 15 million violations per day. [National Association of State Directors of Pupil Transportation, Stop Arm Survey](#)

In Nevada, 744 school bus drivers reported 1,188 stop arm violations on a single day!

When Passing Vehicles are Required to Stop

1. Any driver of a vehicle, when meeting, from either direction, a school bus whose system of red flashing lights and crossing arm have been activated, shall bring his vehicle to an immediate stop and shall not proceed until the school bus has turned off the system of flashing lights and crossing arm.
2. A vehicle on a divided highway need not stop when meeting a school bus on the opposite side of the road.
3. A vehicle need not stop upon meeting or passing a school bus where traffic is controlled by a traffic officer. [Nevada Revised Statue 484B.353](#)

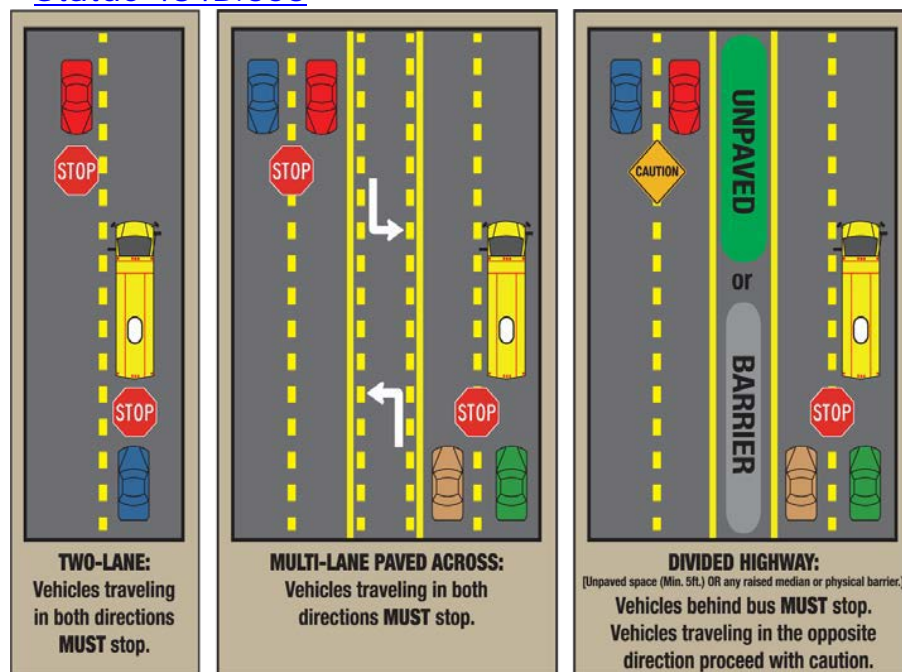

Definition of a Divided Highway

A divided highway is a highway divided by a physical barrier or dividing section, constructed so as to impede the traffic traveling

in opposite directions. [Nevada Revised Statute 484A.070](#)

Penalties for Stop Arm Violations

Anyone found guilty of a stop arm violation will be convicted of a misdemeanor. For the first offense you will be fined between \$250.00 and \$500.00, for a second offense you will be fined \$250.00 to \$500.00 and your license will be suspended for 6 months. For a third offense, you will be fined not more than \$1,000.00 and your license will be suspended for one year. [Nevada Revised Statute 484B.353](#)

It is illegal for school bus drivers to pass other school buses that are stopped, with stop arms activated, who are loading and unloading students! (except on divided highways with physical barriers)

[Nevada Revised Statute 484B.363](#)

Report by a School Bus Driver of a Stop Arm Violation

The driver of a school bus who observes a stop arm violation may prepare a report of the violation. The report must be signed by the driver and include:

1. The date, time and approximate location of the violation;
 2. The number and state of issuance of the license plate of the vehicle; and
 3. An identification of the vehicle by type and color.
- [Nevada Revised Statute 484B.357](#)

SYSTEM OF LIGHTS, STOP ARMS AND CROSSING CONTROL ARM

Every school bus must be equipped with a system of alternating flashing

amber lights, alternating flashing red lights, stop arms and a crossing control arm.

Alternating Flashing Amber/Yellow Lights

1. Are used to warn drivers that the school bus is planning to stop.
2. There are two in the front and two in the rear, visible up to 500 feet.
3. Is activated at least 200 feet in advance of the stop by the driver.
4. Is deactivated by the driver once the bus is stopped and the door is opened and the alternating flashing red lights, stop arms and crossing control arm are activated.

Alternating Flashing Red Lights, Stop Arms and Crossing Control Arm

1. Flashing red lights, stop arms and crossing control arm are to be activated once the bus has come to a complete stop.
2. The flashing red lights, crossing arm and stop arms are only to be used for loading and unloading students and at times of emergency.
3. The use of the crossing control arm **is not** required when the **school bus is solely** used to transport students with special needs who are individually loaded and unloaded and are not required to walk in front of the bus.
[Nevada Revised Statue 386.840](#)



White Flashing Strobe Light (Optional)

1. Optional white flashing strobe lamp may be installed on the roof of a school bus. The strobe light may be mounted on the roof in the area directly over the restraining barrier on the driver's side.
2. The strobe lamp may be wired to activate with the amber alternately flashing signal lamps, continuing through the full loading or unloading cycle and may be equipped with an override switch to allow activation of the strobe at any time for use in inclement weather.

SCHOOL ZONES AND SCHOOL CROSSING ZONES

School Zones

1. School zones are sections of street which are adjacent to school property. [Nevada Revised Statute 484B.063](#)
2. A person shall not drive a motor vehicle at a speed in excess of 15 mph in an area designated as a school zone except:
 - a. On a day when school is not in session;
 - b. During the period from a half hour after school is out to a half hour before school is to start; or
3. If the zone is designated by an operational speed limit beacon, and the yellow lights are not flashing in the manner which indicates that the speed limit is in effect.



School Crossing Zones

1. School crossing zones are the section of streets **not** adjacent to school property that pupils cross while following a designated walking route to school. [Nevada Revised Statute 484B.060](#)
2. A person shall not drive a motor vehicle at a speed in excess of 25 miles per hour in a designated school crossing zone except:
 - a. On a day when school is not in session;
 - b. During the period from a half hour after school is out to a half hour before school is to start; or
 - c. If the zone is designated by an operational speed limit beacon, and the yellow lights are not flashing in the manner which indicates that the speed limit is in effect. [Nevada Revised Statute 484B.363](#)

U-Turns and Passing in a School Zone or School Crossing Zone

1. The driver of a vehicle shall not make a **U-turn** in an area designated as a school zone or school crossing zone; and
2. Shall not **overtake and pass** another vehicle or school bus traveling in the same direction in an area designated as a school zone or school crossing zone, except:
 - a. On a day when school is not in session;
 - b. During the period from a half hour after school is out to a

half hour before school is to start; or

- c. If the zone is designated by an operational speed limit beacon, and the yellow lights are not flashing in the manner which indicates that the speed limit is in effect. [Nevada Revised Statue 484B.363](#)

Move-Over Laws

1. The incidents of law enforcement and emergency medical services, fire department personnel and people working on the road are being struck while performing duties at the roadside are increasing at a frightening pace. Move-over laws have been enacted, which require drivers to slow and change lanes when approaching a roadside incident or emergency vehicle. [Nevada Commercial Driver License Manual](#), (pg. 2-18)
2. When approaching any traffic incident, the driver of the approaching vehicle shall, in the absence of other directions given by a law enforcement officer shall:
 - a. Decrease your speed;
 - b. Be prepared to stop;
 - c. If possible, drive in a lane that is not adjacent to the lane or lanes where the traffic incident is located; and
 - d. A traffic incident means any vehicle, person, conditions or other traffic hazard which is located on or near a roadway and which poses a danger to the flow of traffic or to a person involved in, responding to or assisting with a traffic hazard. This includes:
 - ✓ Emergency vehicles;
 - ✓ Towing vehicles;
 - ✓ Public Utility vehicles;
 - ✓ Governmental agencies;

- ✓ Vehicles using their flashing warning lights;
- ✓ A crash scene;
- ✓ A stalled vehicle;
- ✓ Debris in the roadway; or
- ✓ A person who is out of his or her vehicle attending to a repair.

[Nevada Revised Statute 484B.607](#)

LOADING AND UNLOADING PROCEDURES

Each school district establishes official routes and official school bus stops. All stops must be approved by your school district prior to making the stop. [Nevada Revised Statute 386.790](#) and [Nevada Commercial Driver License Manual](#), (pg. 10-3)

You **cannot** change the location of a bus stop without written approval from your supervisor.

You must use extreme caution when approaching a school bus stop. You are in a very demanding situation when entering these areas. It is critical that you understand and follow all state and local laws and regulations regarding approaching a school bus stop. This would involve the proper use of mirrors, alternating flashing lights, stop signal arm, and crossing control arm. [Nevada Commercial Driver License Manual](#), (pg. 10-30)



Approaching the Stop

1. Activate your turn signal, 100 feet in residential and 300 feet on highways and get into the right lane far in advance of the stop.
2. Approach the stop cautiously at a slow rate of speed.
3. Look for pedestrians, traffic, or other objects before, during and after coming to a stop.
4. Continuously check all mirrors by doing a 5-count mirror check.
5. Activate alternating flashing student amber/yellow lights at least 200 feet or approximately 3-5 seconds before the stop.
6. Turn on right turn signal about 100 feet or approximately 3-5 seconds before pulling over.
7. Continuously check all mirrors by doing a 5-count mirror check to monitor the danger zones for students, traffic, and other objects.
8. Stay to the right side of the roadway in the traffic lane, not on the shoulder, when loading and unloading. Do not try to block traffic.
9. Stop before you get to the students. Make them walk to you so you can see them.
[Nevada Commercial Driver License Manual](#), (pg. 10-4)
10. Never pull into a group of students hanging around the curb or in the street. Stay back and wait for the students to clear the loading zone before you pull in.

When Stopping

1. Bring the school bus to a full stop with the front bumper at least 10 feet away from students at the designated stop. This forces the students to walk to the bus so you have a better view of their movements.
2. Place transmission in Park, or if there is no park shift point, in Neutral and set the parking brake at each stop.

3. Activate alternating red lights or open the door when traffic is a safe distance from the school bus and ensure stop arm is extended.

[Nevada Commercial Driver License Manual](#), (pg. 10-4)

When in doubt, check it out!

Loading Procedures

1. Make sure all passing vehicles have stopped. Before completely opening the door and signaling students to approach.
2. Train students to wait in a designated location for the school bus, facing the bus as it approaches.
3. Students should board the bus only when signaled by the driver.
4. Monitor all mirrors continuously using the 5-count mirror check.
5. Count the number of students at the bus stop and check to make sure the same number board the bus. If possible, know names of students at each stop. If a student is missing, ask the other students where the student is.
6. Have students board the bus slowly, in single file, and use the handrail. The dome light should be on while loading in the dark.
7. Wait until students are seated and facing before moving the bus.
8. Check your mirrors, using the 5-count mirror check. Make certain no one is running to catch the bus.
9. If you cannot account for a student outside, secure the bus, activate hazards if your student loading lights do not operate

when you take the key, and check around and underneath the bus after all students have loaded.

[Nevada Commercial Driver License Manual](#), (pg. 10-4)

10. As student board the bus, remind them to buckle up if bus equipped with lap/shoulder belts
11. Students must be seated entirely within the confines of the school bus seat compartment. In order to protect children, they must be fully seated within the compartment and cannot be sitting sideways or in the aisle. [National Highway Traffic Safety Administration, Number of Persons that Can Sit on a School Bus Seat](#)
12. When all students are accounted for, prepare to leave by:
 - a. Engaging the transmission;
 - b. Releasing the parking brake;
 - c. Close the door, deactivating the alternating flashing red lamps;
 - d. Activate left turn signal;
 - e. Allow traffic to clear;
 - f. Do a 5-count mirror check;
 - g. Allow congested traffic to disperse; and
 - h. When it is safe, move the bus to enter traffic and continue on your route.

[Nevada Commercial Driver License Manual](#), (pg. 10-4)

**Unloading students is far more dangerous
than loading them!**

Unloading Procedures

DRAFT

1. Activate your turn signal, 100 feet in residential and 300 feet on highways and get into the right lane far in advance of the stop. Have the students remain seated until told to exit.
2. Approach the stop cautiously at a slow rate of speed.
3. Look for pedestrians, traffic, or other objects before, during and after coming to a stop.
4. Continuously check all mirrors by doing a 5-count mirror check.
5. Turn on right turn signal about 100 feet or approximately 3-5 seconds before pulling over.
6. Place transmission in Park, or if there is no park shift point, in Neutral and set the parking brake at each stop.
7. Activate alternating red lights or open the door when traffic is a safe distance from the school bus and ensure stop arm is extended.

**A driver's supervision doesn't just
start when students are on the bus!**

8. Signal the students when it is safe to stand up and exit the bus. Make sure students exit in an orderly fashion.
9. Count the number of students while unloading and confirm the location of all students before pulling away.
10. If you cannot account for a student outside the bus, secure the bus, activate hazards if your student loading lights do not operate when you take the key, and check around and underneath the bus after all students have loaded.
11. Continuously check all mirrors by doing a 5-count mirror check. [Nevada Commercial Driver License Manual](#), (pg. 10-4)
12. Never drop a student off at an unassigned stop.

13. At the end of each run, check for hiding/sleeping students or items left behind.



Additional Procedures for Student That Must Cross the Road

You should understand what students should do when exiting a school bus and crossing the street in front of the bus. In addition, the bus driver should understand that students might not always do what they are supposed to do.

1. If students must cross the roadway, instruct them to:
 - a. Walk at least 10 feet away from the side of the school bus to a position where you can see them;
 - b. Walk to a location at least 10 feet in front of the right corner of the bumper, but still remaining away from the front of the school bus;
 - c. Count the number of students while unloading to confirm the location of all students; and
 - d. Have students stop at the right edge of the sidewalk/roadway. You should be able to see the student's feet.
2. Check all mirrors again by doing a 5-count mirror check.
3. When it is safe, and all vehicles have stopped, signal students

to cross. By waving your hand in a sweeping motion. Upon your signal, students need to:

- a. Cross far enough in front of the school bus to be in your view;
- b. Stop at the left edge of the school bus, stop, and look again for your signal to continue to cross the roadway;
- c. Stop at the left edge of the school bus, stop, and look again for your signal to continue to cross the roadway;
- d. Look for traffic in both directions, making sure the roadway is clear; and
- e. Proceed across the roadway, continuing to look in both directions.

[Nevada Commercial Driver License Manual](#), (pg. 10-5)



4. Make sure no students are around or returning to the bus.
5. If you cannot account for a student outside the bus, secure the bus, activate hazards if loading lights are not operational, take the keys, get out, and check around and underneath the bus.

Do not signal for students to cross the street unless you are certain all traffic has/will stop for students!

6. When all students are accounted for, prepare to leave by:

- a. Closing the door;
- b. Engage the transmission;
- c. Release the parking brake;
- d. Turn off alternating flashing red lights;
- e. Turn on your left turn signal;
- f. Check all mirrors again, using the 5-count mirror check;
- g. Allow congested traffic to disperse; and
- h. When it is safe, move the bus, enter the traffic flow and continue the route.

Loading and Unloading Procedures at School

Unloading students in school parking lots or other locations off the traveled roadway are different than loading along the school bus route. It is important that the school bus drivers understand and obeys state and local laws and regulations.

1. When unloading at the school you should perform a safe stop as outlined in **Approaching the Stop and Unloading Procedures** section above.
2. Secure the bus by:
 - a. Turning off the ignition;
 - b. Removing the key if leaving the driver's compartment;
 - c. Have the students remain seated until told to exit;
 - d. Position yourself to supervise unloading;
 - e. Have students exit in an orderly fashion;
 - f. Observe students as they step from the bus to see that all have moved away from the unloading area/danger

zone;

- g. Walk through the bus and check for hiding/sleeping students and items left by students;
 - h. Do a 5-count mirror check. Make certain that no students are returning to the bus; and
 - i. If you cannot account for a student outside the bus, secure the bus and get out and check around and underneath the bus.
3. When all students are accounted for, prepare to leave by:
- a. Closing the door;
 - b. Fastening safety belt;
 - c. Starting engine;
 - d. Engaging the transmission;
 - e. Releasing the parking brake;
 - f. Turning off alternating flashing red lights;
 - g. Activate turn signal;
 - h. Check all mirrors, doing a 5-count mirror check;
 - i. Allow congested traffic to disperse; and
 - j. When it is safe, pull away from the loading/unloading zone.
[Nevada Commercial Driver License Manual](#), (pg. 10-5
4. State law says that you shall not idle a bus for more than 15 consecutive minutes. If parking at a school or any other parking lot, you must turn off your engine after 15 minutes.
[Nevada Revised Statute 445B.575](#)

You are not allowed to idle your school bus engine for more than 15 minutes.

[Nevada Revised Statute 445B.575](#)

Special Dangers in the Loading and Unloading Zone

1. Dropped or forgotten objects. Always focus on students as they approach the bus and watch for any who disappear from sight.
2. Students may drop an object near the bus during loading and unloading and attempt to retrieve the dropped object. Students need to be taught that it is very dangerous and they need to stay away from the danger zone. Stopping to pick up the object or returning to pick up the object may cause the student to disappear from the driver's sight at a very dangerous moment.
3. Students need to be taught that it is very dangerous and they need to stay away from the danger zone. Instruct students that if they have dropped or forgotten something, they need to get the driver's attention prior to retrieving the object.
4. **The school bus handrail hang-ups.** Students have been injured or killed when clothing, accessories, or even parts of their body get caught in the handrail or door as they exit the bus.
[Nevada Commercial Driver License Manual](#), (pg. 10-5)
5. **Schools and school zones.** Children and parents are not watching out for the school bus. Train students not to push or shove when getting on and off the bus. Teach them about the danger zone and why it can be dangerous for students.

Teach your students to NEVER cross behind the bus.

Preventing Incidents in the Loading and Unloading Zone

1. Don't rush

- a. This means don't speed.
- b. Take each stop one at a time.
- c. Concentrate on what you are doing.
- d. Don't get lazy and complacent and skip over part of the loading/unloading procedures.

2. If you are running late on a route, don't hurry. Safe is better than sorry.

3. Safety first, schedule second.

4. **Never move the bus.** If students are in the danger zone, do not move the bus.

5. **Don't deal with on-bus problems** when loading or unloading students. Wait until the students have safely loaded or unloaded the bus to handle issues.

6. Use a **consistent hand signal** to tell students when it is safe to cross the street. The hand signal should not be confused with a wave because waiting motorists might think you are telling them to pass.

7. **NEVER** signal students to cross the street until you have assured all approaching vehicles have stopped!

8. Use a consistent **danger signal** that means return to the side of the road you started from – **AT ONCE!**

9. Use the external P.A. system, if you have one, to let students know when it is safe to cross the road.

10. **Count and recount.** Know how many students should get **on and off** at each stop.

11. As the students get **off** at a bus stop, count them. Then, before you move the bus, count them again as they move away. Don't move until you are sure that they are all away from the bus and safely off the roadway.
12. If you can't account for a student outside the bus, secure the bus and check around and underneath the bus.
13. **Assume the Worst from Motorists.** Even though they are not supposed to, motorists often pass a stopped school bus. As the school bus driver, you should:
 - a. Constantly check traffic in all directions using the 5-count mirror check;
 - b. Make sure that you give plenty of warning by turning on your yellow flashers early; and
 - c. Don't let students off until you are sure it is safe.
14. Watch emergency vehicles closely. Emergency and police ultimately have the right of way. However, most will not proceed until you have turned off your flashers. This tells them that you have heard the siren and it is safe for them to proceed. If you hear a siren you should:
 - a. Make sure all students are out of the danger zone and then cancel your flashers and deactivate the stop arm; and
 - b. If you hear a siren and students are still on the bus do not allow students off the bus.

LAP/SHOULDER RESTRAINT SYSTEMS IN SCHOOL BUSES

The National Transportation Safety Board (NTSB), as a result of school bus crash investigations, has recommended that new school buses should provide children with the best protection available, which includes 3-point seat belts. [National Transportation Safety Board, School Bus](#)

Safety Report

In November of 2015, the National Highway Traffic Safety Administrator (NHTSA) announced that all school buses should have three-point seat belts. The [National Highway Traffic Safety Administration, Update on Lap/Shoulder Belts in School Buses](#) have reported:

1. A dramatic reduction in behavior and discipline problems.
2. Improved safety and a reduction in crashes due to driver's being less distracted.
3. Increased driver satisfaction with driver's now asking for buses equipped with lap/shoulder belts.
4. Strong parent satisfaction.
5. All new school buses purchased in Nevada on or after before July 1, 2019 will be required to be equipped with 3-point restraint systems. [Nevada Revised Statue 386.837](#)

Student Seat Belt Usage

1. Nevada law currently does not have a mandatory seat belt usage regulation for school buses. Each school/school district has the authority to develop policies and procedures for usage and penalties for non-usage. School bus drivers must know their school/school district policy on enforcement and usage.
2. School bus drivers should promote usage even without a mandatory usage policy by the school/school district.
3. Under [Nevada Revised Statue 484D.495](#), drivers may not be considered as negligent or as a causation in any civil action or negligent for a violation of the requirement for use of lap/shoulder belts.
4. [The Institute for Transportation Research and Education at North Carolina State University](#) provides resources for local education agencies to develop seat belt programs.

Proper Use of 3-Point Lap Shoulder Belts

1. Train students to sit flat against the backseat.
2. Train students to place the lap shoulder belt over the shoulder and around the upper body. Do not let the belt get twisted.
3. Train students to buckle the latch plate into the matching buckle after pulling out the shoulder belt webbing from the seatback. Listen for the CLICK sound when the latch plate is fastened.
4. Train students to make sure that the lap belt is properly positioned below the waist, not over the stomach.
5. Train students to position the shoulder-height adjuster at or just above the shoulder. The belt should not cross the face of neck.

Lap-Shoulder Belt Basics

"Buckle, Check, Tight — Your Seat Belt Is Right!"

Common Seat Belt Parts

I have read and discussed these important safety instructions with my child.

Parent/Guardian Signature: _____ Date: _____

Child: _____ Date: _____

Instructor: _____ Date: _____

BUCKLE	CHECK	TIGHT
<div style="text-align: center;"> <p>A</p> </div> <p>A BUCKLE the latch plate into the matching buckle after pulling out the shoulder belt webbing from the seatback. LISTEN for the CLICK sound when the latch plate is fastened!</p> <p><i>Be sure to:</i></p> <ul style="list-style-type: none"> • Sit flat against the seatback. • Place the lap-shoulder belt over shoulder and around upper body. Do not let the belt get twisted. 	<div style="text-align: center;"> <p>B</p> </div> <p>B CHECK that the buckle connection is secure by tugging firmly on the seat belt latch plate.</p> <p><i>Be sure to:</i></p> <ul style="list-style-type: none"> • CHECK while sitting against the seatback. • Remove any twists in the seat belt when you CHECK. 	<div style="text-align: center;"> <p>C</p> </div> <p>C TIGHTEN the lap portion by pulling upward on the shoulder belt. Be sure that the shoulder belt is snug across the chest and crosses the center of the shoulder.</p> <p><i>Be sure to:</i></p> <ul style="list-style-type: none"> • Properly position lap portion below the waist, not over the stomach. • Position the shoulder-height adjuster at or just above the shoulder. The belt should not cross the face or neck.

6.











Improper Use of 3-Point Lap Shoulder Belts

1. Instruct students to never sit in front of the buckled lap-shoulder belt.
2. Instruct students to never place the shoulder belt behind their back and wear only the lap belt.
3. Instruct students to never place the shoulder belt under their arm.
4. Instruct students to never allow the belt webbing to be twisted. It should lay flat against your body.
5. Instruct students to never insert the latch plate of your

shoulder belt into the buckle for the seat beside you. Be sure students use their own buckle.

6. Instruct students to never wear their backpack when seated in the bus. Place it on the floor in front of your feet.

7. Never sit on the front or side edge of your seat.

UNBUCKLING	
 <ol style="list-style-type: none">1. Push the red button on the buckle and remove the latch plate from the buckle.2. Allow the shoulder belt to retract into the upper seatback so webbing is not loose.	 <ol style="list-style-type: none">3. As a courtesy to the next passenger, move the shoulder-height adjuster up to its highest position.
IMPROPER LAP-SHOULDER BELT USE	
 <p>NEVER sit in front of the buckled lap-shoulder belt.</p>	 <p>NEVER allow the belt webbing to be twisted. It should lay flat against your body.</p>
 <p>NEVER place the shoulder belt behind your back and wear only the lap belt.</p>	 <p>NEVER insert the latch plate of your shoulder belt into the buckle for the seat beside you. Be sure to use your own buckle.</p>
 <p>NEVER place the shoulder belt under your arm.</p>	 <p>NEVER wear your backpack when you are seated in the bus. Place it on the floor in front of your feet.</p>
 <p>NEVER wear the shoulder belt or lap belt loosely.</p>	 <p>NEVER sit on the front or side edge of your seat.</p>

© 2014 NCSBSP Rev 01/07/14

[National School Transportation Specifications and Procedures, 2015](#) (pg. 397)

LEAVING STUDENTS ON THE SCHOOL BUS

Students are being left on school buses more often than reported. But the consequences can be deadly for the student and traumatic for the bus driver. That is why it's important to develop a routine for checking for students after each run.

Psychology professors indicated it's actually pretty easy to leave kids in cars/buses. That people believe that cognition works better than it

actually does. Perception, attention and memory all have strong limitations. [Kids and Cars.org](http://KidsandCars.org)

Things like a change in your routine, stress and multiple life factors can distract drivers. [School Bus Fleet Magazine](#)

Why Students are Left on the Bus

Even good drivers can leave students on the bus. Some of the Main reasons that contribute to such incidents are:

1. Sudden and stressful situations can push our intentions from our active mind into our subconscious;
2. Inattentional blindness, when a driver remembers to do a check of the bus and simply does not see the child;
3. Not having your mind on your job at all times;
4. Driver fatigue;
5. Complacency I checked the bus before and no one has ever been there;
6. That would never happen to me; and
7. Drivers can be so focused on a task that they entirely miss something unusual, like a sleeping child.

**Remember to check under the seats
for sleeping students!**

Consequences for School Bus Drivers Who Leave Children on the Bus

1. Leaving a child on the bus can cause psychological trauma to children.
2. Children left on school buses can be injured while escaping from the bus.

3. Children can be injured or die due to extreme hot and cold weather.
4. Drivers have been terminated after leaving a student on the school bus.
5. Child neglect charges.
6. Catastrophic change in the life of bus drivers who leave students on the bus.
7. Public and personal humiliation.

Once you get back to the bus yard, walk the bus again checking for students.

Steps for Preventing Leaving Students behind

1. Constant driver training along with keeping drivers conscious of the dangers of complacency and importance of being vigilant.
2. Post reminders in the bus yard to check for students after each trip.
3. Have a way to verify that the driver has walked the bus and checked for students. These methods can be as simple as "Empty Bus" placard that must be placed in the back of the bus after the last run to video surveillance and electronic monitors.
4. Keeping count of all students that board the bus and make sure the same number have exited the bus.
5. Drivers should teach children to use the horn and two- radio system, including how to turn it on, and how to use the emergency exits so that they can get help if they are left on the bus.
6. Understand sudden and stressful situations and avoid changes

in patterns.

7. Avoid being complacent with the attitude that it won't happen to me. Everyday good parents leave their kids in vehicles by accident.
8. Be diligent when checking for students, not just a walk to the back of the bus but checking under seats or areas where children can hide.

SECTION 8: STUDENT MANAGEMENT

Student management on school buses and at the school bus stop is one of the biggest problems confronting school bus drivers. In order to get students to and from school safely and on time, you need to be able to manage your students so you can concentrate on driving.

Students riding your bus must understand from the beginning that you cannot allow anyone's actions to keep you from providing for the safety of your passengers and yourself. The relationships you will experience daily are with individuals whose behavior ranges somewhere between that of an infant and a young adult. Without a clear understanding of who is in charge, the conditions could become unmanageable and potentially dangerous for everyone. The climate that exists on the school bus is up to you!



STEPS FOR APPROPRIATE STUDENT MANAGEMENT

1. Understand students and what it is like to be an adolescent: the excitement, the fears, the uncertainty, the need to belong, and the need to get attention. Anticipate possible problem times when students will be more excited, distracted or "rowdy," such as the last day before a vacation, a special holiday or an event.
2. Anticipate emergencies. Plan ahead for emergency situations and determine how you will manage student behavior during them. Which students will need more reassurance or structure or direction during an emergency? Which students can you count on for assistance?
3. Monitoring behavior on a bus is using common sense. If two

children are not getting along, separate them.

4. Confronting students in front of their peers is never a good idea. This is a form of punishment and will tend to have negative results. Always allow students to save face by approaching them on a one-on-one basis. Talk with them when the other students are not around. Remain calm, dignified and offer them choices.
5. Any time a student is violating an important safety rule, give the student a direct command.
6. Give students specific directions when you need to do so and let them know the consequences if they choose not to follow the direction.
7. Avoid personality conflicts. Some students' personalities or communication styles may conflict with your own. Some may have annoying behaviors. Again, remember to separate the student from the behavior and treat these students as you treat all others.
8. Treat all students in a casual, friendly way without over-acting or over-reacting in either a positive or a negative manner. Maintain a professional distance between yourself and students.
9. Use a normal, calm tone of voice.
10. If a student wants to argue when you are asking him to behave differently, simply restate your request calmly. If the student asks you why, explain your safety reason, but do so only once. You will never win an argument with a student.
11. Keep your hands to yourself.

[School Bus Fleet Maintain Order on Unruly Routes](#)

Maintain your sense of humor!

When there is a problem

1. Always follow your school's procedure for requesting

assistance.

2. Call 911 for serious, immediate assistance and then contact dispatch.
3. If necessary and approved by dispatch, stop and secure the bus and take the ignition key with you if you leave the seat.
4. Stand up and speak in a firm voice without showing emotion. Address the offender and explain the expected behavior on the school bus.
5. Never put a student off the bus except at school or at his or her designated school bus stop. If you feel that the offense is serious enough that you cannot safely drive the bus, call for a school administrator or the police to come and remove the student.
6. Follow your school's procedure for requesting assistance.
7. Never put yourself in harm's way.

[Nevada Commercial Driver License Manual](#), (pg. 10-9)

Always call 911 for serious problems that are an immediate threat to the safety of your students and you.



STUDENT RESPONSIBILITIES

Proper student behavior is important because the distraction of the driver can contribute to crashes. Students and parents should be made

aware of, and abide by school bus regulations for enhanced safety. Students and parents should:

1. Be aware that they are responsible for their actions and behavior;
2. Receive a copy of the rules and procedures and should be required to comply;
3. Display respect for the rights and comfort of others;
4. Be taught to realize that school bus transportation is a privilege not a right that can be denied to students who break the rules;
5. Be made aware that any time the bus driver is distracted it is potentially hazardous to the safety of all passengers, the bus driver, other pedestrians and motorists;
6. Be informed of the dangers of loose clothing, drawstrings, clothing accessories, backpacks and other loose personal items;
7. Be made aware of the dangers involved walking to and from, in and around the loading and unloading zone. Students should be trained to cross the road safely at the bus stop and should be taught to avoid retrieving articles dropped in the danger zone of the bus during loading and unloading activities, or otherwise when they are in the area around the bus, without explicit directions from the driver. Student should also be taught to move away from the bus after unloading.
[National School Bus Specification and Procedures, 2015](#) (pg. 139)
8. Know the rules and consequences of their actions.

STUDENT RULES

1. Students shall follow directions of the driver the first time given.
2. Students shall arrive at the bus stop no more than 10 minutes before the bus arrives.
3. Students shall wait in a safe place, clear of traffic and away from where the bus stops.

4. Students shall wait in an orderly line and shall avoid horseplay.
5. Students shall cross the road or street in front of the bus only after the bus has come to a complete stop and upon direction of the driver.
6. Students shall go directly to an available or assigned seat when entering the bus.
7. Students shall remain seated, forward facing and within the compartment. Aisles and exits must remain clear.
8. Students shall exhibit classroom conduct at all times.
9. Students shall refrain from throwing or passing objects in, from or into the buses.
10. Students are permitted to carry only objects that can be held on his/her lap.
11. Students shall not use profane language or obscene gestures.
12. Students shall not use tobacco, tobacco devices, smokeless tobacco, liquid tobacco, vaper or e-cigs or alcohol, drugs or any other controlled substance on the bus.
13. Students shall not carry hazardous materials or non-service animals into the bus.
14. Students shall respect the rights and safety of others.
15. Students shall refrain from leaving or boarding the bus at locations other than the assigned stop.
16. Student shall refrain from extending head, arms or objects out of the bus windows.
17. Students shall refrain from hitching rides via the rear bumper or other parts of the bus.

[National School Bus Specifications and Procedures, 2015](#) (pg.

362)



QUIET TIME

The practice of quiet time is a great way to start off your route. Quiet time is usually observed for a short period of time in the morning before arriving at school, and in the afternoon while pulling away from the school. You may also determine that quiet time is necessary during an emergency situation and at railroad crossings.

MUSIC ON THE BUS

The use of music in a school bus should be minimal and be calming to your students. If used, the volume must be kept low enough so that you can hear all that is going on around you.

Some school districts have lists of approved radio stations/music, while some school districts do not permit the use of these devices at all. Be sure to check your school district policy.

Students are not allowed to play their music without headphones while on the bus.



VIDEO MONITORING SYSTEMS

School districts now use video monitoring systems in order to protect students and drivers. It does not replace the discipline policy, the authority of the driver, or the responsibility of school officials. It is simply a tool to aid the driver and district administrators.

If there is a video monitoring system on your school bus, students and drivers will be notified if they are subject to being videotaped.

Evidence obtained from video monitoring systems can be used for disciplinary action against a driver or student.

TRANSPORTING HOMELESS CHILDREN

McKinney-Vento Homeless Assistance Act

The McKinney-Vento program is designed to address the problems that homeless children and youth have faced in enrolling, attending, and succeeding in school. Under this program, Local Education Agencies (LEAs) must ensure that each homeless child and youth has equal access to the same free, appropriate public education, including preschool education, as other children and youth. [United States Department of Education's Homeless Children and Youth Program](#)

Lack of transportation is the number one barrier that homeless children and youth faced in attending school regularly.

[United state Department of Education, Homeless Student Guide](#) (Pg. 19)

Definition of Homeless Children and Youth

1. Individuals who lack a fixed, regular, and adequate nighttime resident.
2. Children and youth who are sharing the house of other persons due to loss of housing, economic hardship, or a similar reason;

are living in motels, hotels, trailer parks, or camping grounds due to the lack of alternative adequate accommodations; are living in emergency or transitional shelters; or are abandoned in hospitals.

3. Children and youth who have a primary nighttime residence that is a public or private place not designed for or ordinarily used as a regular sleeping accommodation for human beings.
4. Children and youth who are living in cars, parks, public spaces, abandoned buildings, substandard house, bus or train stations, or similar settings.
5. Migratory children who qualify as homeless because the children are living in circumstances described above.
[National Center for Homeless Education \(NCHE\), Transporting Children and Youth Experiencing Homelessness](#)<add>

Summary of Key Provisions of McKinney-Vento

Students who have been identified as homeless by their school district liaison must be provided transportation to and from their school of origin.

In addition to providing transportation to the school of origin, schools must provide students with transportation services comparable to those provided to other students.

1. Local Educational Agencies (LEAs) must provide homeless students with transportation to and from the school of origin at the request of a parent or guardian, or in the case of an unaccompanied youth.
2. In addition to providing transportation to the school of origin, LEAs must provide students with transportation services comparable to those provided to other students in the school.
3. Homeless students must be provided services comparable to those offered to other students in the school, including transportation.

[National Center for Homeless Education, Transporting Children and Youth Experiencing Homelessness](#)



School Bus Drivers and Homeless Students

School bus drivers must be very sensitive to homeless students. A student's living situation must be kept confidential and school bus drivers need to be kind and assist these students through this difficult time in their lives with as little disruption as possible.

Developing close ties among school homeless liaisons, school staff and your supervisor is critical.

Drivers need to be sensitive to homeless children and keep their living conditions confidential!

SECTION 9: SECURITY, SAFETY, REPORTING & CONFIDENTIALITY

SECURITY

Each school day almost 20 percent (50 million) of the United States population is located in our nation's schools. Approximately half of these children (25 million) use a school bus for transportation to and from school each day. Additionally, millions of children ride school buses each day for school activity trips.

Identifying Security Threats

School bus security begins with you, your knowledge and your best judgment. Being able to define and identify security threats and incidents will help you determine the appropriate course of action.

1. A **security threat** is any source that may result in an event or occurrence that endangers life or property and may result in the loss of services or equipment.
2. A **security incident** is an unforeseen event or occurrence that does not necessarily result in death, injury, or significant property damage, but may result in interruption of service.
[Transportation Security Administration's Security Guide](#)

The school bus driver and passengers are more likely to be targets of violence from students, parents and unauthorized boarders.

Recommended Security Procedures

In addition to knowing your state and school's established procedures, the following guidelines can help ensure the safety and security of your student's and yourself.

1. Take the Transportation Security Administration's [First Observer Program](#) course.
2. Wear your required school uniform or identification badge.
3. Keep all vehicle doors, hatches, and compartments locked when the school bus is unattended.
4. Conduct pre-trip, security and post-trip inspections.
5. Maintain an uncluttered bus.
6. Be constantly aware of people, activities and items around you.
7. Immediately report any operational security weaknesses, suspicious persons or packages and any damage to the school

bus or school bus yard.

[Transportation Security Administration, School Bus Security](#)

Trust your GUT!

Responding to a Security Incident

If you are threatened or involved in a security incident, remain calm and stay focused. When reporting, it is important that the information is accurate, detailed, and pertinent. Providing authorities with status of victims, indicators, and circumstances will assist with the effectiveness and timeliness when responding. When you have a security incident, you should:

1. Contact law enforcement/911 for immediate emergency assistance;
2. Notify dispatch or your supervisor immediately;
3. Report your exact location and any other pertinent information;
4. Identify type of threat and describe suspicious behavior, device(s), package(s) or odors;

You cannot identify suspicious behavior based on stereotypes of race, color or ethnicity.

5. Observe and notice weather conditions, especially wind direction for suspicious odors, mist, vapor or powder;
6. Identify eyewitnesses;
7. For incidents that might involve a suspicious package, avoid using radios and cellular phones within 50 feet of package that may be explosives;
8. Remain calm and answer questions to the best of your recollection;

9. Clarify by repeating instructions just given;
10. Know your school's procedures to report and safely challenge any unidentified person in unauthorized or secured areas such as schools and bus yards;
11. Know the emergency procedures for your school; and
12. Know your school districts communication protocols and emergency codes for dispatch.

Always call 911 for any serious, immediate threat!

Security Inspection

Anytime you leave the bus unattended (not in your line of sight) for any length of time, you must do a quick security inspection. TSA recommends checking the following areas for suspicious packages, devices, substances, unattended baggage, briefcases, etc.:

- A. Floors;
- B. Seats;
- C. Driver's area;
- D. Steps;
- E. Wheelchair lift;
- F. Lights;
- G. Wheel wells;
- H. Engine compartments;
- I. Exhaust System;
- J. Fuel and air tanks; and

K. Back/side emergency exit door(s).



[Transportation Security Administration, School Bus Security](#)

**The legal age of consent does not apply
to a student!**

SAFETY

Safe and Respectful Learning Environments

A safe and respectful learning environment is essential to emotional and academic achievement. Bullying is illegal in Nevada and is defined by regulation:

1. Repeated or pervasive taunting, name-calling, belittling, mocking or use of put-downs or demeaning humor regarding the actual or perceived race, color, national origin, ancestry, religion, gender identity or expression, sexual orientation, physical or mental disability of a person, sex or any other distinguishing characteristic or background of a person.

2. Behavior that is intended to harm another person by damaging or manipulating his or her relationships with others by conduct that includes, without limitation, spreading false rumors.
3. Repeated or pervasive nonverbal threats or intimidation such as the use of aggressive, menacing or disrespectful gestures.
4. Threats of harm to a person, to his or her possessions or to other persons, whether such threats are transmitted verbally, electronically or in writing.
5. Blackmail, extortion or demands for protection money or involuntary loans or donations.
6. Blocking access to any property or facility of a school.
7. Stalking.
8. Physically harmful contact with or injury to another person or his or her property.

[Nevada Revised Statue 388.122](#)

A Safe Learning Environment

1. A learning environment that is safe and respectful is essential for pupils to achieve academic success. Learning environments include the school bus.
2. Employees of the school district must demonstrate appropriate and professional behavior and treat others with civility and respect.
3. Employees should not tolerate bullying and cyber-bullying, and take immediate action to protect a victim or target of bullying.

[Nevada Revised Statue 388.132](#)

Cyber-bullying is the use of electronic communication to transmit or distribute sexual images. [Nevada Revised Statue 388.123](#)

Threatening or Assaulting an Employee or Student

1. It is illegal to interfere or threaten or assault a pupil or school employee.
 - a. On the way to and from school. [Nevada Revised Statute 392.900](#)
 - b. Within the building or grounds of the school.
 - c. On a bus, van or other motor vehicle owned, leased or chartered by a school district to transport pupils or school employees.
 - d. At a location where the pupil or school employee is involved in an activity sponsored by a school. [Nevada Revised Statute 392.910](#)
2. It is also illegal to threaten a pupil or school employee by oral, written or electronic communication with the intent to:
 - a. Intimidate, harass, frighten, alarm or distress a pupil or employee of a school;
 - b. Cause panic or civil unrest;
 - c. Interfere with the operation of a school; and
 - d. Through the use of cyber-bullying, threaten to cause bodily harm or death to a pupil or school employee with the intent to:
 - ✓ Intimidate, harass, frighten, alarm or distress;
 - ✓ Cause panic or civil unrest; and
 - ✓ Interfere with the operation of a school. [Nevada Revised Statute 392.915](#)

Harassment is Unwelcome and Unwanted!

SEXUAL MISCONDUCT WITH STUDENTS

1. As a bus driver, you are an employee of a school and that makes it illegal to have inappropriate contact with any student.
2. Although the age of consent in Nevada is 16 years old, it is illegal for an employee of a public or private school, to engage in sexual conduct with any student who is enrolled and attending school. [Nevada Revised Statue 201.540](#)

**Respect the student's right to privacy.
Handle complaints of harassment and
bullying immediately with care and
confidentiality.**

MANDATORY REPORTING

As a school employee, you are legally responsible to report all incidents of abuse or suspected abuse, threats or suspected threats to schools or students and bullying.

Requirements for Reporting

1. Any employee who have cause to believe an act, event, situation or conditions exists, is occurring or has occurred as soon as reasonably practicable.
2. Any employee, club or organization which uses the facilities of any school, regardless of any connection to the school or pupil, shall not engage in bullying or cyber-bullying on school property or at a school sponsored event or on any school bus.
3. Any employee who witnesses or receives information of any violation listed above shall report the violation to the principal or his/her designee as soon as reasonable practicable but not later than the same day.
4. Upon receiving a report, the principal shall immediately take

any necessary action to stop the bullying and ensure the safety and well-being of the victim and begin an investigation into the report.

[Nevada Revised Statute 388.135](#)

Requirements for Reporting Suspected Child Abuse

1. If you have reasonable cause to believe that a child has been abused or neglected you shall:
 - a. Report the abuse or neglect of the child to an agency which provides child welfare services or to a law enforcement agency; and
2. Make such a report within 24 hours after you know or have reasonable cause to believe that the child has been abused or neglected. [Nevada Revised Statute 432B.220](#)
3. In addition to the reporting requirements listed above in [Nevada Revised Statute 432B.220](#), school employees and volunteers who have a reasonable cause to believe that a child has been subject to the following by another employee or volunteer must report as soon as reasonably practicable, but not later than 24 hours suspected:
 - a. Abuse, neglect, sexual conduct or luring; or
 - b. Corporal punishment by another employee or volunteer. [Nevada Revised Statute 392.303](#)

How to Report Violations

Schools are required to establish policies and procedures to report violations to a school police officer or local law enforcement agency. [Nevada Revised Statute 388.1352](#)

Reporting Child Abuse:

To report suspected child abuse or neglect in Nevada, you can call the Child Abuse Hotline at these numbers:

Clark County: (702) 399-0081

Washoe County: (775) 785-8600

All other Nevada counties: (800) 992-5757

Immunity from Reporting

No action may be taken against any employee or student who reports bullying unless the person made the report with malice, intentional misconduct, gross negligence, or intentional or knowing violation of the law. [Nevada Revised Statute 388.137](#)

Failure to Report

If you fail to report suspected abuse, you could be guilty of a misdemeanor for the first offense and a gross misdemeanor for the second offense. [Nevada Revised Statute 432B.240](#)

Immunity from Civil or Criminal Liability

Any person who makes a report in good faith, of suspected abuse is immune from civil or criminal liability. [Nevada Revised Statute 432B.160](#)

SafeVoice

[SafeVoice](#) is an anonymous reporting system used to report threats to the safety or well-being of students. [SafeVoice](#) was established to protect student wellness, prevent violence and save lives.

The [SafeVoice](#) program is in partnership with the Nevada Department of Public Safety and provides a safe place to submit tips 24/7/365 concerning their own safety as well as the safety of others.

CONFIDENTIALITY

DRAFT

There are several federal regulations that address student and employee confidentiality that you should be aware of.

Family Educational Rights and Privacy Act (FERPA)

[Code of Federal Regulations 99.30, Family Education Rights & Privacy](#) protects the privacy of student education records. Schools must have written permission from the parent or eligible student in order to release any information from a student's education record. However, FERPA allows schools to disclose those records, without consent, to the following parties under the following conditions:

1. School officials with legitimate educational interest;
 2. Other schools to which a student is transferring;
 3. Specified official for audit or evaluation purposes;
 4. Appropriate parties in connection with financial aid to a student;
 5. To comply with a judicial order or lawfully issued subpoena; and
 6. Appropriate officials in cases of health and safety emergencies.
- [United States Department of Education, FERPA Guidance](#)

School transportation officials, including the bus driver, have a legitimate educational interest in knowing medical and safety issues of the students being transported.

Health Insurance Privacy and Portability Act (HIPPA)

The goal of HIPPA is to assure that individual's health information is properly protected while allowing the flow of health information needed to provide and promote high quality health care. It protects *individual identifiable health information* (PHI) held or transmitted to the school.

It is important to protect student health information and keep that

information confidential.

[United States Department of Health & Human Services, Summary of the HIPPA Privacy Rule](#)

Employee Confidentiality

Employers are required to keep some employee information confidential. All employee information should never be shared. It is also important to remember not spread rumors or gossip.

SECTION 10: EXTRA- CURRICULAR ACTIVITY AND FIELD TRIPS

Extra-curricular activity and field trips are an important part of school for many students. These trips require additional knowledge and skills to assure a safe and successful trip.



ON-DUTY TIME AND HOURS-OF-SERVICE REGULATIONS

When transporting students to extra-curricular activities, it is important for you to know hours of service regulations and what on-duty time means.

On-Duty Time Includes

All the time from the time a driver begins to work or is required to be in readiness to work until the time the driver is relieved from work and all responsibility for performing work and includes:

1. All time spent at a facility waiting to be dispatched;
2. All time inspecting, servicing or conditioning any school bus;
3. All time spent driving a school bus;
4. All time spent on the school bus, other than driving time;
5. All time needed for loading and unloading, supervising or assisting the loading and unloading of students, and any time waiting for students;
6. All time used for repairing, obtaining assistance, or waiting for

assistance to repair a disabled vehicle;

7. All time spent being tested for drugs and alcohol, including travel time to and from the collection site;
8. Performing any other work as a common, contracted or private motor carrier; and
9. Performing any work for a non-motor carrier.

[Federal Motor Carrier Safety Regulation 395, Hours of Service](#)

You are required by federal law to include all duties performed for which you were compensated by any employer.

What is Not Considered On-Duty Time

1. Time spent resting in a parked vehicle;
2. Time spent resting in a hotel;
3. When relieved of all duty and responsibility for the care and custody of the vehicle or passengers it is carrying.
4. Any rest break of at least 30 minutes as off-duty time provided:
 - a. The driver is relieved of all duty and responsibility for the care and custody of the vehicle, its accessories, and any cargo or passengers it may be carrying; and
 - b. During the stop, and for the duration of the stop, the driver must be at liberty to pursue activities of his/her own choosing.

[Federal Motor Carrier Safety Regulation 392, Guidance Q & A](#)

Hours-of-Service Rules

Nevada hours-of-service regulations exceed federal hours-of- service

regulations. In Nevada you must follow the below regulations.

1. Cannot operate a vehicle or school bus for more than 10 hours in a 15-hour period.
2. After driving 10 hours and/or operating a vehicle in a 15-hour period, you must rest (be off-duty) for 10-hours. [Nevada Revised Statue 386.815](#)
3. Drivers who drive extra-curricular activity trips that travel out of state should keep a log book showing on-duty time. [Federal Motor Carrier Safety Regulation 395.8, Driver's Record of Duty Status](#)
4. Drivers who encounter adverse driving conditions and who cannot, because of these conditions, safety completely the run within the maximum driving time are permitted to drive for not more than 2 additional hours. [Federal Motor Carrier Safety Regulation 395.1, Scope of Rules in this Part](#)

Drivers who are traveling with the bus must count that time as on-duty.

MAXIMUM SPEED LIMITS FOR SCHOOL BUSES ON EXTRA-CURRICULAR ACTIVITIES

1. School buses **SHALL NOT** exceed 55 mph when transporting student to and from school.
2. School buses **CAN** drive the posted speed limit when transporting students to and from activities (extra-curricular, sports, field trips) that are part of the school program. [Nevada Revised Statue 484B.360](#)
3. School districts have the authority to establish a maximum speed limit.

School buses can drive the posted speed limit when transporting students to and from activities (extra-curricular, sports, field trips).

PLANNING FOR AN EMERGENCIES

An emergency situation can happen to anyone, anytime, anywhere. It could be a crash, a stalled school bus on a railroad crossing, a high-speed intersection, an electrical fire in the engine compartment or a medical emergency of a student on the school bus. Knowing what to do in an emergency-before, during and after an emergency can mean the difference between life and death. [Nevada Commercial Driver License Manual](#), (Pg. 10-6)

DRILLS TO PRACTICE EVACUATION

Nevada Law requires that you practice the evacuation of a school bus and receive instruction in the responsibility of a passenger of a school bus to use the emergency exit doors on the bus during such an evacuation **at the beginning of any field trip by school bus**. Instruction should include:

1. The responsibility of passengers on a school bus, including where and how to use the emergency exit doors and windows during an evacuation;
2. Procedures to safely enter and exit a school bus;
3. Appropriate behavior and conduct while on a school bus;
4. The location of emergency equipment on a school bus; and [Nevada Revised Statute 386.820](#)
5. If chaperones or parents are riding the school bus for the first time, they will need to practice and receive instruction for an emergency evacuation drill.

PLANNING THE TRIP

1. Plan and follow routes in detail so your school district knows the route you plan to take and the estimated arrival time.
2. Check on weather conditions.
3. Make sure to know the location where you are going and the location where you are picking up students.
4. Be familiar with the bus you are taking and do a thorough pre-trip inspection before leaving.
5. Know who your chaperones will be and explain the safety and discipline rules on the bus. Make sure your chaperones participate in the emergency evacuation drill prior to the trip and receive instruction in emergency procedures.

Remember, the bus driver has the final authority and responsibility on the school bus!

6. Have a list of passengers that includes names, addresses, date of birth and phone numbers, provided by your school. In the event of a crash, this information will be required.
7. Know what type of equipment you will be required to carry. You will need to be sure that you have proper storage space for extra equipment.

Federal law forbids blocking the aisle, door, steps and emergency exits!

8. During your trip plan for stops. You should attempt to stop every 2 hours to refuel, allow your students to use the restroom or eat. Every time your passengers leave the bus, arrange a time and place for re-boarding. Make sure to account for all passengers prior to departure.

9. Remember the rules for driving in hazardous conditions like rain, heat, snow and check tires and fluids at stops.
10. Anytime you leave the bus unattended for any length of time, it is important to do a security inspection of your vehicle. You must walk around the vehicle checking for vandalism, suspicious packages, devices, substances, unattended baggage, tire damage or engine tampering. There is no time requirement for this type of inspection. Anytime the bus is left unattended (no longer in visual sight of the driver) a quick inspection must be done. You are still required to do a full-post trip inspection.
11. When doing a security inspection you need to check the following areas:
 - A. Floors;
 - B. Seats;
 - C. Driver's area;
 - D. Steps;
 - E. Wheelchair lifts;
 - F. Lights;
 - G. Wheel wells;
 - H. Engine compartments;
 - I. Exhaust System;
 - J. Fuel and air tanks; and
 - K. Back/side emergency exit door(s).



[Transportation Security Administration's, School Bus Security](#)

12. Be prepared to stop at all inspection stations even though your school bus is inspected by the Nevada Highway Patrol twice a year. Be prepared to show that you conducted your pre-trip inspection.
13. Consider tolls, parking fees or other minor related expenses and who will pay for them.
14. Keep a log showing your off-duty, driving and on-duty, not driving time. Check your school district for an approved log sheet.
15. Check yourself throughout the trip to make sure you are in safe operating condition.

**You are required to keep a student roster,
including seating positions of the students.**

EMERGENCY PLANNING FOR THE TRIP

Being prepared is the best way to handle an emergency. You will need to:

1. Be familiar with your schools safety protocols and communication requirements in the event of an emergency;

2. Have a list of emergency phone numbers and contact information;
3. Have insurance and vehicle registration in case of a crash;
4. Have a blank seating chart;
5. Have medical information on students;
6. Have evacuation procedures; and
7. Know the location of first-aid kit, body-fluid kit, fire extinguisher, emergency exits, belt cutter, and emergency shut-off switches.

EXTRA RISKS WITH ACTIVITY TRIPS

Field and activity trips pose a greater risk to student safety than to and from school transportation because:

1. Drivers are often unfamiliar with the route and the bus;
2. Driving speeds are usually higher;
3. Trips often take place at night where visibility is less;
4. There is a greater risk of fatigue;
5. Students may not be regular riders and may be unfamiliar with the bus and the rules for students; and
6. Students and chaperones can be distracted by the excitement of the event or competition they are attending.

SECTION 11: EMERGENCY EQUIPMENT AND PROCEDURES

School bus drivers must always plan for emergencies. That is why school buses are equipped with emergency equipment and exit doors and windows. You will need to know what emergency equipment is on the school bus, where it is located and how it's used. In addition you will need to know procedures when an emergency occurs.

EMERGENCY EQUIPMENT

Every school bus in Nevada is required to carry the following emergency equipment.

Alternating Flashing Yellow & Red Lights

Every school bus operated for the transportation of pupils to and from school must be equipped with a system of alternating flashing yellow/red lights that the driver shall operate when the bus is preparing to stop and when it has stopped to load/unload pupils, and in times of an emergency or crash. [Nevada Revised Statute 386.840](#)



Belt Cutters

Each school bus which transports students in a wheelchair or other assistive restraint devices that utilize belts or any school bus equipped with passenger restraint systems shall contain at least two belt cutters secured in a location within reach of the driver while belted into his/her driver's seat.

First Aid Kit

Each school bus must have a sealed, removable, moisture-proof First Aid Kit in an accessible place in the driver's compartment. It shall be mounted and identified with one inch letters as a First Aid Kit. If stored in a compartment, the compartment must be clearly labeled, easily accessible to the driver and not blocked.

Minimum Contents include:

- 2 1 inch x 2 ½ yards of adhesive tape rolls
- 24 Sterile gauze pads 3 x 3
- 50 ¾ x 3 inches adhesive bandages
- 8 2 inch bandage compress
- 10 3 inch bandage compress
- 2 2 inch x 6 foot sterile gauze roller bandages
- 2 Non-sterile triangular bandages, minimum 39x35x54 inches with two safety pins
- 3 Sterile gauze pads 36 x 36 inches
- 3 Sterile eye pads
- 1 rounded-end scissors
- 1 Pair medical grade examination gloves
- 1 mouth-to-mouth airway

**Extra bandages should be kept
separate from the First Aid Kit.**

Body Fluid Clean-Up Kit

Each school bus shall have a sealed, removable, moisture-proof

Body Fluid Clean-Up Kit accessible to the driver, securely mounted and labeled. If located in a compartment, the compartment must be clearly labeled in one inch letters, be easily accessible to the driver and not blocked.

The Body Fluid Clean-Up Kit shall be a minimum 10 unit kit that is OSHA/ANSI Compliant.

Minimum contents include:

- 1 Absorbent powder
- 1 Disinfectant cloth
- 1 Scoop & spatula
- 2 pair - Medical grade gloves
- 10 Paper towels
- 1 Biohazard bag
- 1 Personal protective apparel pack
- 1 Large down

Your school bus can be placed out-of-service if the First Aid and Body Fluid Clean-Up Kits are blocked when stored in an overhead compartment!

Emergency Warning Devices

Each school bus shall contain at least three (3) reflectorized triangle road-warning devices mounted in an accessible place. [Feder Motor Carrier Safety Regulation 392.22, Emergency Signals, Stopped Commercial Motor Vehicles](#)

Fire Extinguishers

The school bus shall be equipped with at least one UL-approved pressurized, dry chemical fire extinguisher. The extinguisher shall be secured in a mounted bracket, located in the driver's compartment and readily accessible to the driver and passengers. A pressure gauge shall be mounted on the extinguisher and shall be easily read without moving the extinguisher from its mounted

position.

The fire extinguisher shall have a rating of 2-A: 10-BC, or greater. The operating mechanism shall be secured with a type of seal that will not interfere with the use of the fire extinguisher. [National School Transportation Specifications and Procedures, 2015](#) (Pg. 41)

A fire extinguisher may not put a fire out, but it will provide you with valuable time to get students off the bus!

Spare Fuses

When required, at least 1 spare fuse or other loaded protective devices, if the devices used are not of a reset type of each kind and size used.

EMERGENCY PROCEDURES

In an emergency situation always call 911!

Emergency Evacuation Procedures

As a general rule, student safety and control is best maintained by keeping students on the bus during an emergency. But there are certain emergencies that would require you to evacuate the school bus. This will usually be a split second decision that you will have to make as the driver. You need to evacuate the bus when the following conditions occur:

1. The bus is on fire or there is a threat of fire;
2. The bus is stalled on or adjacent to a railroad-highway crossing;
3. The position of the bus may change and increase the danger of collision;

4. There is an imminent danger of collision;
5. The school bus is in water; or
6. There is a hazardous materials spill.

[Nevada Commercial Driver License Manual](#), (Pg. 10-7)



Emergency Warning Devices

You are required to place emergency warning devices on the highway whenever your bus is stopped for any cause other than necessary traffic stops. Emergency warning devices need to be placed within 10 minutes of your vehicle being disabled. Emergency warning devices need to be placed as follows:

1. One-Way or Divided Highway – Place warning devices 10 feet, 100 feet, and 200 feet toward approaching traffic.

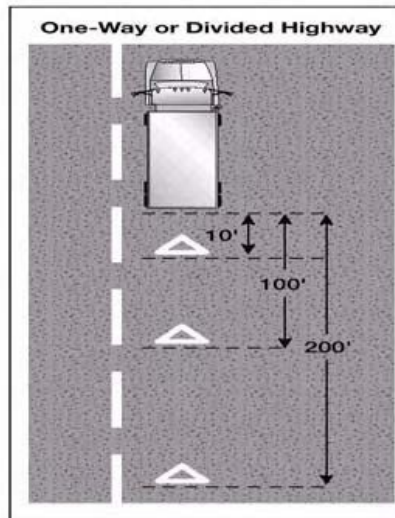

2. Two-lane road on an undivided highway – Place warning devices within 10 feet of the front or rear corners to mark the location of the vehicle and 100 feet behind and ahead of the vehicle.

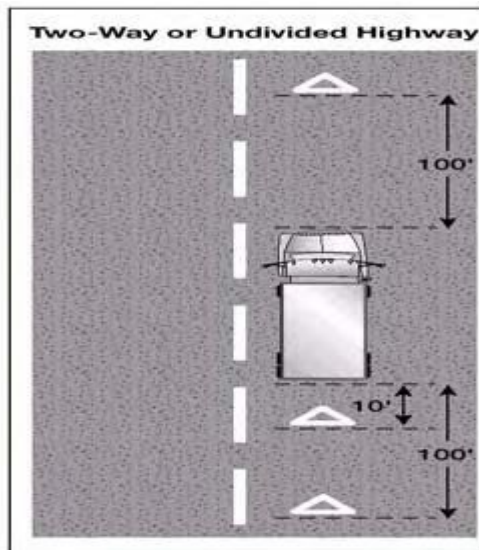

3. Beyond a hill, curve, or other obstructed view – An obstruction that prevents other drivers from seeing your vehicle within 500 feet. If line of sight view is obstructed due to a hill or curve, move the rear-most triangle to a point back down the road so warning is provided.
[Nevada Commercial Driver License Manual](#), (Pg. 2-13)

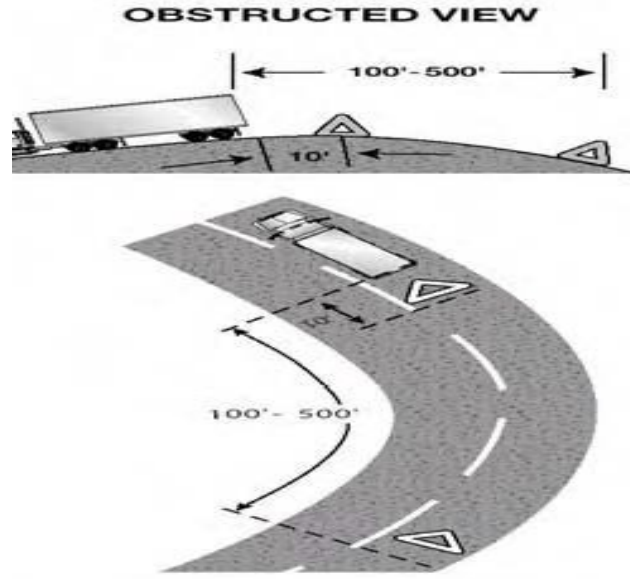

Fire Extinguisher

1. You should only use the fire extinguisher:
 - a. Once you have evacuated all students to a safe place;
 - b. The fire is small and contained to a single object; and
 - c. You are safe from the toxic smoke produced by the fire.

2. Do not use the fire extinguisher:
 - a. If the fire is spreading beyond the spot where it started;
 - b. If you can't fight the fire with your back to an escape exit; and
 - c. If the fire can block your only escape.

How to Operate a Fire Extinguisher

To operate an extinguisher:

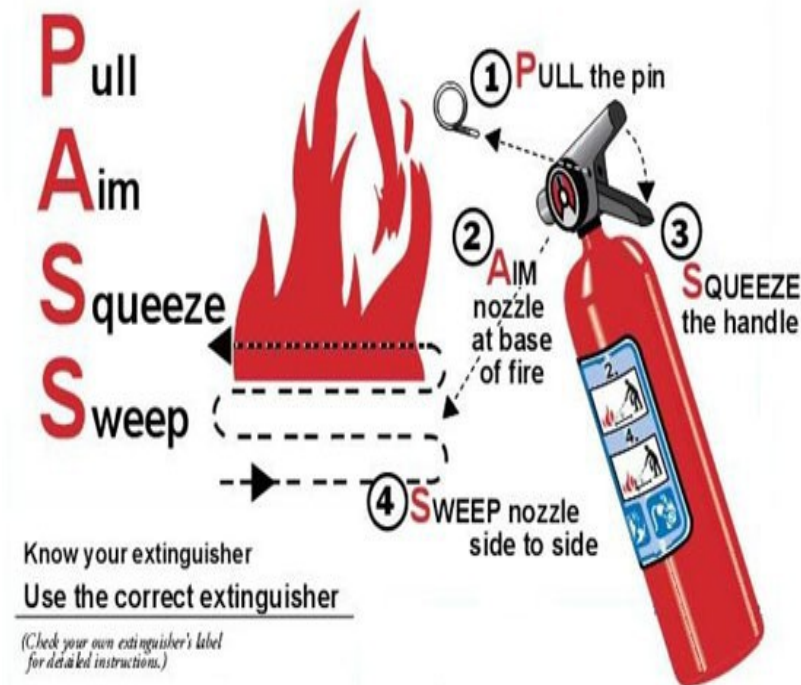

EMERGENCY EVACUATION PROCEDURES

At least twice each school year, schools are required to practice the evacuation of a school bus and receive instruction in the responsibility of a passenger of a school bus to use the emergency exit doors on the bus during an evacuation. [Nevada Revised Statue 386.820](#)

Emergency Evacuation Procedures

Practicing emergency evacuations is not only required, but extremely important if an actual evacuation is required. Emergency evacuation procedures must be explained to all students. This includes knowing how to operate various emergency exits and the importance of listening to and following all instructions.

1. You should only evacuate the school bus if the following

DRAFT

conditions exist.

- a. If there is a fire or there is danger of a fire.
- b. If there is a smell of raw or leaking fuel.
- c. If there is a chance the school bus could be hit by another vehicle.
- d. If the bus is in the path of a sighted tornado or rising waters.
- e. If there are there downed power lines.

2. If you must evacuate the school bus in an emergency, the following must be considered:

- a. Are there responsible, older students who can provide assistance at emergency exits? Teach them how to assist the other students off the bus. This can be done when practicing emergency evacuation drills prior to the trip?
- b. Determine the best type of evacuation. Can students be evacuated through all emergency exits, or just through the front, rear, side or roof evacuation exits?

3. Determine a safe place.

- a. At least 100 feet off the road in the direction of oncoming traffic. This will keep the students from being hit by debris if another vehicle collides with the bus.
- b. Upwind if the bus is on fire.
- c. As far away from railroad tracks as possible and in the direction of any oncoming train.
- d. Upwind of the bus at least 300 feet if there is a risk from spilled hazardous materials.

- e. In the direct path of a sighted tornado. Escort students to a nearby ditch or culvert if shelter in a building is not readily available. Direct them to lie face down, hands covering their head.
 - f. Not subject to flash floods.
4. General procedures for evacuating the bus.
- a. Notify dispatch of emergency location, conditions, type of assistance needed and plan to evacuate the school bus;
 - b. Activate hazard warning lights;
 - c. Place the transmission in park, or if there is no shift point, in neutral;
 - d. Set the parking brake;
 - e. Shut off the engine;
 - f. Remove ignition key;
 - g. Notify dispatch of evacuation location, conditions, and type of assistance needed;
 - h. Dangle radio microphone out of the driver's window for later use, if possible; and
 - i. Take electronic communication devices.
[Nevada Commercial Driver License Manual](#), (pg. 10-7)
5. Order the evacuation by giving the command PREPARE TO EVACUATE and provide instruction as to what emergency exits are going to be used by:
- a. Having a student or adult assistant take their assigned posts at emergency exits;

- b. If evacuating out the front exit door, turn toward the front of the bus and begin moving backwards to the first occupied seats. Have assistants do the same when evacuating students out the rear or side emergency exits;
 - c. Starting with either the left or the right seat, touch the shoulder of the person nearest to the aisle to indicate that the students in that seat needs to get up and head for the exit; and
 - d. Keep the students in the opposite seat by holding your hand on their shoulder until you are reaching for them to evacuate.
6. Move down the aisle repeating this procedure until the bus is empty.
 - a. Lead students to the nearest safe place.
 - b. Never move a student you believe may have suffered a neck or spinal injury unless his or her life is in immediate danger. Special procedures must be used to move neck spinal injury victims to prevent further injury.
 - c. Once students are evacuated:
 - ✓ Walk through the bus to ensure no students remain on the bus;
 - ✓ Retrieve emergency equipment;
 - ✓ Join waiting students. Account for all students and check for their safety;
 - ✓ Protect the scene. Set out emergency warning devices as necessary and appropriate; and
 - ✓ Prepare information for emergency responders. [Nevada Commercial Driver License Manual](#), (pg. 10-7)

CRASH PROCEDURES

If you are in crash in the school bus, follow these procedures:

Remain calm and DO NOT MOVE THE BUS!

1. Stop the bus and do not move it without permission of the investigating officer;
2. Set the brake, turn off ignition and activate hazard lights;
3. Notify dispatch of crash location, conditions, and type of assistance needed;
4. Call 911 for emergency assistance;
5. Remain calm and survey the scene;
6. Account for all students and assess the situation;
7. Secure the scene;
8. Evacuate the bus if necessary;
9. Take the keys and place emergency warning devices;
10. Collect the names of students and establish a seating chart; Law enforcement officials will require a seating chart at the time of the crash;
11. Do not discuss the crash; and
12. Do not release any of your students unless authorized.

Any statement you make about a crash can be used in court. Do not discuss causes of the crash with other involved. Do not admit guilt and let the proper authorities handle the case.

BREAKDOWNS

If you experience a breakdown, you should:

1. Slow down, activate your turn signal, and move to the far right lane if possible. You can also pull off onto a shoulder in order to prevent a crash;
2. Set the parking brake, turn off the ignition, set hazard lights, and remove the keys;
3. Notify dispatch of breakdown and follow instructions;
4. Take your keys and place emergency warning devices as described above; and
5. Evacuate the bus only if necessary.

**Never leave students unattended
to seek assistance!**

DUTY TO RENDER AID

Nevada requires the driver of any vehicle involved in a crash resulting in injury, death, or damage to any vehicle or property, shall:

1. Give his name, address and the registration number of the vehicle he is driving, and upon request, provide his license to any person injured in such crash.
2. Give such information and upon request, surrender such license to any police officer at the scene of the crash or who is investigating the crash.
3. Render to any person injured in such crash reasonable assistance, including the carrying, or the making of arrangements for the carrying, of such person to a physician, surgeon or hospital for medical or surgical treatment if it is apparent that such treatment is necessary, or if such carrying

is requested by the injured person.
[Nevada Revised Statue 484E.030](#)

PROCEDURES FOR RENDERING AID

If you stop due to a crash to render aid, you need to:

1. Stop in a safe place;
2. Set the parking brake, turn off the ignition and turn on your hazard lights;
3. Notify dispatch of crash and 911 if necessary. Follow dispatch instructions;
4. If you are getting off the bus to render aid, notify dispatch;
5. Take you keys and communication devices;
6. Place emergency warning devices as described above; and
7. Provide first aid if necessary.

NEVADA'S GOOD SAMARITAN LAW

Nevada law states that any person, who renders emergency aid, gratuitously and in good faith, is not liable for any civil damages as a result of any act or omission, not amounting to gross negligence, by him/her in rendering the emergency care or assistance, or as a result of any act or failure to act, not amounting to gross negligence, to provide or arrange for further medical treatment for the injured person. [Nevada Revised Statue 41.500](#)

UNIVERSAL STANDARDS

First Steps in Providing First Aid

1. You can be required to provide first-aid as a bus driver who can have a range of injuries. Always contact 911 for any emergency or serious injury.

2. For minor injuries, provide first aid as required. All school bus drivers are required to have training in emergency procedures and first aid. [Nevada Revised Statue 386.825](#)
3. Basic First Aid
 - a. Applies only to immediate temporary need;
 - b. You are not expected to be a medical doctor and minimal first aid should be administered;
 - c. Follow only school district approved first-aid procedures and your training; and
 - d. Remain calm!

Thorough hand washing is the best tool to prevent the spread of infectious diseases!

Universal Standards for the Spread of Infectious Diseases by Body Fluids

Every school bus driver needs to be aware of universal precautions, which considers every person, all blood and most body fluids to be potential carriers of infectious diseases.

Mouth-to-mouth airways are designed to isolate you from contact with a victim's saliva and body fluids. Avoid using unprotected mouth-to-mouth resuscitation.

Body Fluid Clean-Up Kit

Each School Bus shall have has a removable and moisture proof Body Fluid Clean-Up Kit that is easily accessible to the driver in the driver's compartment, securely mounted and labeled. If located in a compartment, the compartment must be clearly labeled easily accessible to the driver and not blocked. (See Emergency Equipment)

1. Basic Body Fluid clean-up procedures:

- a. Move students away from the contaminated area;
- b. Put on disposable gloves;
- c. Sprinkle absorbent material over spilled area. Liquid will quickly congeal for safer handling;
- d. After 1 minute, remove contaminated material with scoop and scraper. Carefully place in discard bag from kit;
- e. Clean away soils with absorbent towel;
- f. After the spill is removed, apply disinfectant from the kit;
- g. Place all contaminated materials (including gloves) in discard bag. Seal and dispose of bag according to your school district policy;
- h. Wipe hands with anti-microbial hand wipe. Wash with soap and running water as soon as possible; and
- i. If possible, the student's clothing and other soiled, non-disposable items should be placed in a plastic bag and sent home with the student.

You may not know if a student has an infectious disease because state law prohibits disclosing the name of anyone with an infectious disease.

MEDICAL EMERGENCIES

A medical emergency can occur at any time on the school bus. All school bus drivers are required to have training in first aid and CPR. This training will be critical in an emergency. Make sure to follow your training and call 911 in a serious emergency that requires immediate medical attention.

1. Types of medical emergencies you may experience on the school bus:
 - a. Allergic reactions;
 - b. Anaphylactic shock;
 - c. Asthma;
 - d. Bites and stings;
 - e. Bleeding;
 - f. Chocking;
 - g. Dehydration;
 - h. Heat stroke;
 - i. Hyperventilation;
 - j. Nose bleeds; and
 - k. Seizures.

SECTION 12: TRANSPORTING STUDENTS WITH SPECIAL NEEDS

Federal law mandates that students with disabilities must be allowed to participate with nondisabled students in both academic and non-academic services, including transportation.

Transporting students with disabilities and special health care needs requires specially designed transportation as a “related service.”

LAWS AFFECTING TRANSPORTATION FOR STUDENTS WITH SPECIAL NEEDS

1. The [Rehabilitation Act of 1973](#) protects the rights of students with disabilities in programs and activities and requires that no disabled individual be excluded from participating in, or be denied the benefits of any program receiving federal financial assistance.
2. Students with a disability must be provided a [Free and Appropriate Education \(FAPE\)](#) and must be educated with their nondisabled students. A student with disabilities must be placed in the regular education environment, unless it can be demonstrated that the student’s needs cannot be met satisfactorily with the use of supplementary aids and services.
3. The [Individuals with Disabilities Education Act \(IDEA\)](#) is the law that makes available a free and appropriate public education to eligible children with disabilities and ensures related services to children and youth ages 3 through 21. The purpose of IDEA is:
 - a. To ensure that all children with disabilities have to them a free and appropriate public education that emphasizes special education and related services designed to meet their unique needs and prepare them for further education, employment, and independent living;
 - b. To ensure that the rights of children with disabilities and parents of such children are protected; and

- c. To ensure that educators and parents have the necessary tools to improved educational results for children with disabilities by supported system improvement activities; coordinated technical assistance and support.
4. The [Family Educational Rights and Privacy Act \(FERPA\)](#) protects the privacy of student education records. FERPA gives parents certain rights with respect to their children’s education records. Generally, schools must have written permission from the parent or eligible student in order to release any information from student’s educational record. However, FERPA does allow schools to disclose those records, without consent, to the following parities:
- a. School officials with legitimate educational interest;
 - b. Other schools to which a student is transferring;
 - c. Specified official for audit or evaluation purposes;
 - d. Appropriate parties in connection with financial aid to a student;
 - e. Organizations conducting certain studies for or on behalf of the school;
 - f. Accrediting organizations;
 - g. To comply with a judicial order or lawfully issued subpoena; and
 - h. Appropriate officials in cases of health and safety emergencies.
5. The [Health Insurance Portability and Accountability Act \(HIPAA\)](#) assures that individual health information is protected while allowing the flow of important health information needed to provide and promote high quality health care. It protects individual identifiable health information (PHI) held or transmitted to the school.



TERMS AND DEFINITIONS

1. **Assistive technology device.** A piece of equipment, or product system modified or customized, that is used to increase, maintain, or improve functional capabilities of a child with a disability.
2. **Assistive technology service.** Any service that directly assists a child with a disability.
3. **Child with a disability.** A child who has been evaluated as having an impairment for which the child needs special education and related services. [U.S. Department of Education Section 800.3, Definitions](#)
4. **Special education.** Specially designed instruction, at no cost to the parents, to meet the unique needs of a child with a disability.
5. **Family Education Rights and Privacy Act (FERPA).** Protects student privacy and requires parent/guardian permission for others to access a student's educational record except for school officials who have a legitimate educational interest.
6. **Free Appropriate Public Education (FAPE).** Requires that students with disabilities are entitled to a free education that is appropriate to their age and abilities.
7. **Individualized Education Program (IEP).** A written statement for a student with a disability designed to meet his/her unique educational needs. [United States Department of Education, Guide to IEP's](#)

8. **Local Education Agency (LEA)**. The local education agency is the school district; each IEP team should have an LEA representative who can determine the district's available resources and vouch for the district's implementation of the IEP.
9. **Individual Family Support Plans (IFSPs)**. A plan written for a child, birth to three years. Family involvement is required.
10. **Least Restrictive Environment (LRE)**. Students with disabilities must be educated with their non-disabled peers to the maximum extent possible. This includes transportation services.
11. **U.S. Office of Civil Rights**. The Office of Civil Rights is in place to protect the rights of students with disabilities and to ensure that school districts are complying with the law.

INDIVIDUALIZED EDUCATION PROGRAM (IEP)

The IEP team is a formal group that designs a student's educational program, establishes measureable academic and functional goals and determines the related services necessary for a student to access special education.

When transportation is considered, appropriate transportation staff, as related services providers, needs to be included in the IEP process to address the safety and feasibility of various transportation options.

The IEP team must consider several issues in order to assure the student is transported in the safest and least restrictive environment:

1. Can the student be safely transported on the school bus with other students;
2. If not, can the student be transported safely on the regular education bus if supplementary staff, equipment, and/or services are provided;
3. If not, what type of specialized transportation and/or equipment is required;
4. Is an aide, nurse or other qualified school personnel required;

5. Does the student require a responsible adult available for pick-up and drop off;
6. Is there a limit to the length of time the student can be on the bus;
7. Is the type of transportation requested viable;
8. Additional transportation restrictions that could impact the safe transportation of the student such as:
 - a. Behavior plan;
 - b. English proficiency;
 - c. Vision skills;
 - d. Communication needs; and
 - e. Assistive technology needs.

TRANSPORTATION AS A RELATED SERVICE

If a child requires any of the following related services in order to benefit from special education. Related services include:

1. Audiology services;
2. Counseling Services;
3. Early identification and assessment of disabilities in children;
4. Medical services;
5. Occupational therapy;
6. Orientation and mobility services;
7. Parent counseling and training;
8. Physical therapy;

9. Psychological services;
10. Recreation;
11. Rehabilitation counseling services;
12. School health services;
13. Social work services;
14. Speech-language pathology services; and
15. Transportation!

If a child needs a particular related service, including transportation, then the related service professional needs to be involved in the development of the IEP.

[United State Department of Education's IEP Guide](#)

CATEGORIES OF DISABILITIES DEFINED - AGE 3 THROUGH 21

IDEA lists the following 13 different disability categories for children age 3 through 21 that adversely affect a child's educational performance.

1. **Autism** is a developmental disability that significantly affects verbal and nonverbal communication and social interaction, generally evident before age three. Other characteristics are repetitive activities and movements, resistance to change in daily routines and unusual responses to sensory experiences.
2. **Deaf-blindness** means simultaneous hearing and visual impairments, the combination of which causes such severe communication and other developmental and educational needs that they cannot be accommodated in special education programs solely for children with deafness or children with blindness.
3. **Deafness** means a hearing impairment that is so severe that a child is impaired in processing linguistic information through hearing, with or without amplification.

4. **Emotional disturbance** is a condition exhibiting one or more of the following characteristics over a long period of time and to a marked degree that adversely affects a child's education performance:
- a. Inability to learn that cannot be explained by intellectual, sensory, or health factors;
 - b. Inability to build or maintain satisfactory interpersonal relationships with peers and teachers;
 - c. Inappropriate types of behavior or feelings under normal circumstances;
 - d. A general pervasive mood of unhappiness or depression;
 - e. A tendency to develop physical symptoms or fears associated with personal or school problems;
 - f. Includes schizophrenia; and
 - g. Does not include children who are socially maladjusted, unless it is determined that they have an emotional disturbance.
5. **Hearing impairment.** An impairment in hearing, whether permanent or fluctuating but is not included in the definition of deafness.
6. **Intellectual disability** (formerly mental retardation). Significantly sub-average general intellectual functioning, existing concurrently with deficits in adaptive behavior and manifested during the developmental period.
7. **Multiple disabilities** means simultaneous impairments (such as intellectual disability-blindness, intellectual disability-orthopedic impairment), the combination of which causes such severe educational needs that they cannot be accommodated in special education programs solely for one of the impairments. The term does not include deaf-blindness.

8. **Orthopedic impairment** means a severe orthopedic impairment that includes impairments caused by congenital anomaly, impairments caused by disease (e.g., poliomyelitis or tuberculosis), and impairments from other causes (e.g., cerebral palsy, amputation, fractures or burns).
9. **Other health impairment** means having limited strength, vitality, or alertness, including a heightened alertness to environmental stimuli, that results in limited alertness with respect to the education environment that is due to chronic or acute health problems such as asthma, attention deficit disorder or attention deficit hyperactivity, diabetes, epilepsy, a heart condition, hemophilia, lead poisoning, leukemia, nephritis, rheumatic fever, sickle cell anemia, and Tourette syndrome.
10. **Specific learning disability** means a disorder in one or more of the basic psychological processes involved in understanding or in using language, spoken or written, that may manifest itself in the imperfect ability to listen, think, speak, read, write, spell or do mathematical calculations including conditions such as perceptual disabilities, brain injury, minimal brain dysfunction, dyslexia, and development aphasia. The term does not include perceptual disabilities, brain injury, minimal brain dysfunction, dyslexia, and development aphasia.

It does not include learning problems that are primarily the result of visual, hearing, or motor disabilities, of intellectual disability, of emotional disturbance, or of environmental, cultural, or economic disadvantage.

11. **Speech or language impairment** means a communication disorder such as stuttering, impaired articulation, a language impairment, or a voice impairment.
12. **Traumatic brain injury** means an acquired injury to the brain caused by an external force, resulting in total or partial functional disability or psychosocial impairment or both. The term applies to open or closed head injuries resulting in impairments in one or more areas, such as cognition; language; memory; attention; reasoning; abstract thinking; judgment; problem solving; sensory, perceptual, and motor abilities; psychosocial behavior; physical

functions; information process and speech.

It does not include brain injuries that are congenital or degenerative, or to brain injuries induced by birth trauma.

16. **Visual impairment including blindness** means an impairment of vision that, even with correction. The term includes both partial sight and blindness.

[United States Department of Education, Section 800.3 Definitions](#)

STUDENT BEHAVIOR

In addition to physical limitations and their communication difficulties, some students have unusual or unpredictable behaviors that may startle you if you aren't prepared for them.

What we are talking about are behaviors that the student is unable to control. Some examples include:

1. Rocking;
 2. Unpleasant language or repetitive phrases;
 3. Yelling or calling out or significant swallowing difficulty;
 4. Drooling;
 5. Difficulty sitting upright;
 6. Abnormal breathing patterns;
 7. Startle response to loud noises or fast movement, etc., e.g., to lift operation;
 8. Asthma; and
 9. Seizures.
- [National Highway Traffic Safety Administration's, Transporting Students with Special Needs](#), (Section II, Types of Disabilities and Behaviors)

UNIQUE CHARACTERISTICS

Knowing the unique characteristics of the students you transport will help you to react correctly.

1. Like individuals, disabilities vary greatly.
2. Remember that students are people first and then they are people with disabilities.
3. Your communication with any student with special needs depends on that student's abilities:
 - a. Don't let the focus be the student's condition; and
 - b. Treat each student as an individual.
4. Remember that you treat the student with special needs the same way that you treat any other student of that age.
 - a. Be respectful, don't talk down to the student;
 - b. Be positive and encouraging;
 - c. Allow as much independence as you can safely afford;
 - d. Learn the language of the students on your school bus, both verbal and non-verbal; and
 - e. Don't talk about the student as if he or she isn't there.
5. Remember that you are part of a team that cares about the student.
6. Learn about the student's abilities by:
 - a. Talking with parents, caregivers, teachers, and therapists; and
 - b. Observing the student yourself.

COMMUNICATION

Communicating with the Team

Determining and providing safe transportation for special needs students takes a team. Specialized transportation services must be included in the Individual Education Program (IEP) and the Transportation Department must be included in order to assure that the transportation services provided is safe, in the Least Restrictive Environment and in the best interests of the student.

By law, certain individuals must be involved in writing a child's IEP. If specialized transportation is required, then transportation personnel must also be included in the IEP team.

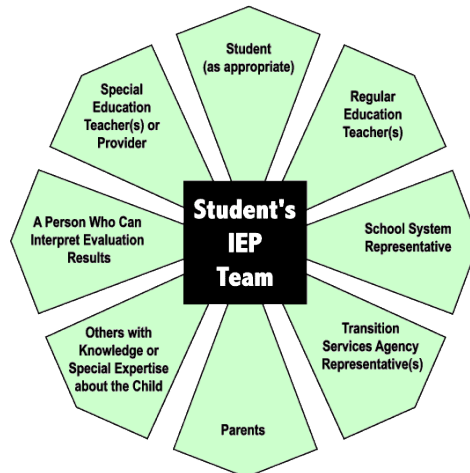

Communicating with Your Transportation Supervisor

Bus drivers are important to providing safe transportation as a related service and must be able to communicate and ask questions to your supervisor. Here are some examples of issues that could arise:

1. Service animals;
2. Wheelchair tires are flat or the battery is run down;

3. No wheelchair when student needs one;
4. Student has a stroller instead of a wheelchair;
5. Wheelchair or safety seat inappropriate for the size of the child;
6. Can't get the child safety restraint secured properly;
7. Securement equipment dirty;
8. A really large oxygen tank;
9. A wagon carrying the oxygen tank;
10. Equipment you might not be familiar with;
11. Being asked to give students medication against policy;
12. Being asked to do an unauthorized drop-off; or
13. How should I handle difficult, unusual or inappropriate requests, from parents, teachers or other staff that have not been approved by your supervisor or the IEP Team.
[National Highway Traffic Safety Administration, Transporting Students with Special Needs](#), (Section III, Team Communication Issues)

Communicating with Parents and Caregivers

1. Remember that you are not alone in dealing with parents and caregivers.
2. You are not obligated to do everything a parent or caregiver requests although some requests may make it easier to transport the student. Know which questions to refer to your supervisor.
3. Be sensitive in dealing with parents and caregivers:
 - a. Be firm but kind;
 - b. Explain why something is done a certain way and refer

them to your supervisor if needed;

- c. Remember that parents and caregivers are advocating for the student's needs. However, they aren't in a position to tell you what your job is and how to do it; and
 - d. Know your districts policy and procedures for communicating with parents and caregivers.
4. Remember that it's not your job to be a go-between with parents and teachers.
- [National Highway Traffic Safety Administration, Transporting Students with Special Needs](#) (Section III, Team Communication Issues)

Communicating with Special Needs Students

1. Know and respect the cognitive capacity of the student.
2. At the level the student can understand, explain what you are going to do and why before you do it. Explain again while you are doing it (if appropriate).
3. It's helpful to explain things in terms of safety reasons. For example, "you need to stay seated because it is not safe for you to be out of your seat."
4. Keep bus rules simple and repeat them often to help students understand. Bus rules should be simple:
 - a. Remain seated;
 - b. Don't touch any bus parts;
 - c. Don't touch other students;
 - d. Keep your seat belt on; or
 - e. Be cooperative.
5. Reinforce bus rules by praising students who follow them.

6. Remember, if a student can't communicate with you, don't assume that the student can't understand you.
[National Highway Traffic Safety Administration, Transporting Students with Special Needs](#) (Section III, Team Communication Issues)

Communicating in Emergencies

1. If you encounter a situation that you hadn't expected, your first response should be to contact dispatch and request advice from your supervisor.
2. If you have a medical emergency, don't delay in notifying dispatch and call 911 if the medical emergency exceeds your training. When contacting dispatch, remember to respect confidentiality when using:
 - a. Radios and cell phones are not secure;
 - b. Use discretion when talking over non-secure lines;
 - c. Avoid using personal identifying information unless you have no other choice; and
 - d. Use a code system to identify the severity of the situation.
3. Depending on the situation you may need to pull the bus over at a safe place, or decide to drive the school bus to the help site or meeting point with emergency personnel.
4. **DO NOT** tell other drivers or non-drivers about the situation. Respect the confidentiality of your students; and
5. Know your school district policies for communicating with emergency responders and your school district.
[National Highway Traffic Safety Administration, Team Communication Issues](#)

SPECIALIZED ASSISTIVE EQUIPMENT

Students with special needs may use a variety of specialized equipment requiring special care and use. One of the most challenging to transport is the wheelchair.

Some of the specialized equipment or assistive devices you might encounter as a school bus driver/attendant of students with special needs are:

1. Braces or crutches;
2. Walker or cane;
3. Wheelchair;
4. Tracheotomy tube;
5. IV or feeding tube;
6. Lap tray;
7. Oxygen equipment;
8. Child safety seat or safety vest;
9. A guide dog/service animal;
10. Extra belt cutters;
11. Do Not Resuscitate (DNR) orders; and [National Highway Traffic Safety Administration, Transporting Students with Special Needs](#) (Section IV, Specialized Equipment)
12. Medical support equipment. This may include respiratory devices, such as oxygen bottles or ventilators. [National Congress on School Transportation Specifications and Procedures](#), (pg. 77)

TRANSPORTING SPECIALIZED ASSISTIVE EQUIPMENT

Transporting Oxygen

Oxygen is a non-flammable substance that is stored in liquid or gas form and used by a student to aid in breathing. In order to transport oxygen, the bus driver needs to know the following information that needs to be documented in the student's IEP.

1. The type and size of the oxygen tank that will be transported, along with an emergency plan in the event of a medical emergency or equipment failure.
2. Oxygen tanks should be no larger than 38 cubic feet for compressed gas.
3. If the student is using the oxygen on an as needed basis. The bus driver cannot make the decision regarding the amount of oxygen needed.
4. Oxygen tanks must be secured in a rack or mounting device that will sustain at least five times the weight of the tank.
5. All oxygen tanks must be kept away from intense heat (130 degrees or higher) or friction.
6. Unless absolutely necessary, only one medical support device per student can be transported at a time.
7. Any changes in medical equipment or required services may require a change in the IEP. Notify your supervisor immediately.
8. School buses are not required to have placards or labeling on the vehicle when transport.

Transporting Service Animals

Service animals are dogs that are individually trained to work or perform tasks for people with disabilities. ADA regulations require that state and local governments, businesses, and nonprofit organizations that serve the public must allow service animals to accompany people with disabilities in areas of the facility where the public is normally allowed.

Bus drivers are not responsible for determining if a service animal is required for a student while being transported on the school bus. If a service animal is required for a student, the IEP should review and approve the service animal on the school bus.

1. Services provided by service animals for students with special needs.
 - a. For students who are physically weak or experience fatigue, service dogs can actually pull them in their wheelchairs, providing longer periods of independent mobility.
 - b. For students who have visual or memory problems, the dogs can help lead them throughout the school and bus area.
 - c. For students with seizure activity, the dogs can actually give the student a warning that they are going to have a seizure.
 - d. For students with balance and walking difficulties, the dogs can provide physical support to aid with walking, balance and coordination.
 - e. For students with limited upper extremity movement and strength, the service dogs can pick up objects that might be out of the students' reach or ability.
 - f. For students who use motorized wheelchairs, service dogs have often been trained to pick up the students' arms if they drop and actually place them back on the wheelchair joystick box.
 - g. For those with phobias or emotional disturbance disorders, the dogs provide a calming effect.
 - h. In many cases, the service animal provides a social opportunity for the child where one would not have

occurred otherwise.

[National School Transportation Specifications and Procedures](#), (pg. 421)

2. Federal rules related to service animals.

- a. Allergies and fear of dogs are not valid reasons for denying access or refusing service to people using service animals. When a person is allergic to dog dander and a person who uses a service animal must spend time in the same room, like the school bus, they both should be accommodated.
- b. A person with a disability cannot be asked to remove their service animal unless the dog is out of control and the student does not take effective action to control the dog.
- c. Students with disabilities who use service animals cannot be isolated from other students or treated less favorably.
- d. Students can be charged for any damage caused by a service animal.
- e. You are not required to provide care or food for the service animal.
- f. In addition to the provisions about service dogs, revised ADA regulations have a new provision for miniature horses that have been individually trained to perform tasks or work with students with a disability.
[United States Department of Justice: ADA Requirements for Service Animals](#)

3. Loading students with service animals.

- a. Never allow a service animal to ride the bus lift.
- b. Lead the service animal up the steps while the student is on the lift and the lift is still on the ground to provide maximum safety for the dog and child.
- c. Ambulatory students should ascend the steps separately, with the service animal boarding first so it doesn't block or

trip the child during boarding.

4. Riding position and safety.
 - a. Once the student and dog are on the bus, the best position for the service animal is between the wheelchair and the bus wall.
 - b. Decisions should be made as to whether the service animal should be restrained or remain free to assist the student according to the student's individual needs. The important thing is to minimize potential injury to the service animal and others on the bus in case of a crash.
 - c. The service animal should never be allowed to block the aisle. Depending on space available, an ambulatory student's service animal may be placed on the floor near the student's immediate seating area.
 - d. The service animal's safety during the actual bus ride with all the stops and acceleration should come into consideration.
 - e. A service animal cannot block any emergency exit.
5. Emergency procedures should be established along with evacuation plans.
 - a. A service animal may be taken off the bus via the steps or allowed to jump of the back of the bus without assistance.
 - b. Students or their parents should train bus staff in basic commands, should the student be unable to give the service animal commands.
 - c. Handling of an injured service animal during an emergency should be left to the direction of the handler. In the event that the handler becomes incapacitated, first responders should determine the best method of evacuation.
 - d. Dog behavior management. If a service animal begins to

bark, groan or whine, question what is causing the service animal to act this way and consult with the student/handler to interpret the behavior when possible. Make sure that something is not wrong with the student or animal.

[National School Transportation Specifications and Procedures](#), (pg. 421)



Wheelchair Tie-down Occupant Restraint System (WTORS)

1. WTORS shall be designed, installed, and operated for use with forward-facing wheelchair-seated passengers. It is important to use a complete WTORS to secure the wheelchair and provide the occupant with a properly designed and tested securement system. When securing a wheelchair in the school bus, you will need the following securement systems.
2. At least 4-point tie-down device for each wheelchair and a 3-point securement system for the student.
3. There are 7 securement points:
 - a. A 4-point securement system that anchors the wheelchair to the vehicle; and
 - b. A 3-point securement system that secures the student in the wheelchair that includes:
 - ✓ A shoulder belt that attaches to the vehicle; and

✓ A lap belt.

4. To protect the occupant, a seatbelt system with both pelvic and upper torso belts must be used.
5. The WTORS, including anchorage track, floor plates, pockets or other anchorages, and shall be provided by the same manufacturer.
6. Wheelchair securement positions shall be located such that wheelchair and their occupants do not block access to the lift door.
7. Immediately after their use, all securement hardware not permanently affixed to vehicle floors and sidewalls (tracks, plate) should be detached and stored in a bag, box or other compartment.
8. A device for storage of the WTORS shall be provided. When the system is not in use, the storage device shall allow for clean storage of the system, shall keep the system securely contained within the passenger compartment, shall provide reasonable protection from vandalism and shall enable the system be readily accessed for use.
9. If the upper torso belt anchorage is higher than 44 inches, measured from the vehicle floor, an adjustment device as part of the occupant restraint system must be supplied.
[National School Transportation Specifications and Procedures](#), (pg. 75)

Storage of Specialized Equipment

1. Specialized equipment must never be secured in:
 - a. Aisles;
 - b. Where it can become a projectile;
 - c. The evacuation path;

- d. A student's lap; and
 - e. Between the seat and the window.
2. Other lightweight items may be secured in:
- a. In seat belts in unoccupied seats;
 - b. Cargo nets fixed to the side or back walls of the school bus;
 - c. Under seats;
 - d. Latched compartments; or
 - e. At the rear of the bus.
3. Remember that all objects can become projectiles in a crash. So all items must be stored properly. This includes brooms and any other supplies or equipment you carry on the school bus.
4. Child safety seats must be either secured to the seat with or without the children, or stored in a storage area, or taken off the school bus with the child.

All securement straps and hardware not secured to the floor and sidewalls must be detached and stored in a bag, box or other compartment. (OOS)

WHEELCHAIRS

There are many kinds of wheelchairs. They range widely in cost from hundreds of dollars to tens of thousands of dollars and have a variety of features. Some examples include:

- 1. Lap trays;
- 2. Forearm positioning device;

3. Tilt and recline options;
4. Various harnesses;
5. Joysticks; and
6. Different head and foot rests.

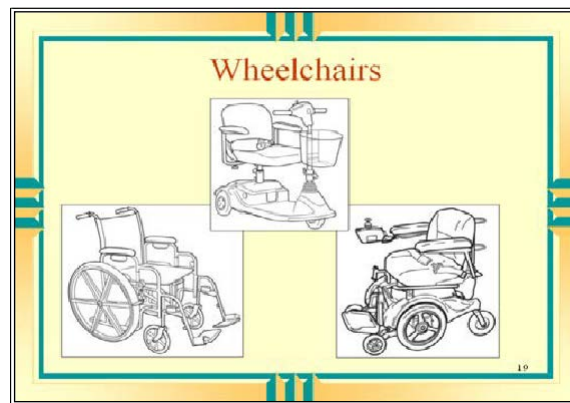

Wheelchair Characteristics

1. Some wheelchairs are manufactured for transportation purposes. When they are, they will have a label stating they are manufactured for transportation.
2. This doesn't mean that students can't use mobile seating devices/wheelchairs that are not manufactured for transportation purposes.
3. Students should be transported in wheelchairs manufactured for transportation or whenever possible be transferred to a regular seat in the school bus.
4. Some students cannot get on the bus without a wheelchair, but can sit in a regular seat. It is recommended that whenever possible, students be transferred to a regular seat on the school bus.
5. The wheelchair must be secured even if not used by the student.

6. Some wheelchairs are not always safe to transport students in. When a wheelchair is structurally unsafe to transport, you will need to contact your supervisor to come up with an alternate transportation plan.

[National Highway Traffic Safety Administration, Transporting Students with Special Needs-Specialized Equipment](#)

7. Some mobile seating devices the student cannot remain seated in during transportation:
 - a. A wheelchair with a sports back; and
 - b. A 3-wheeled scooter.



8. Be aware of:
 - a. An extra heavy wheelchair that requires additional tie-downs; and
 - b. The "tilt-in-space" wheelchair if tilted more than 20 degrees.

Power Wheelchairs

Power wheelchairs are loaded like manual wheelchairs except for the following:

1. The power is switched off and battery is charged before operating the lift;
2. The wheel locks are engaged;
3. For some chairs, the gears on the motors must be disengaged;
4. The gears on the motors should be re-engaged to set the

internal locking mechanism while the wheelchair is on the lift;
and

5. The gears need to be engaged to allow the student or aide to maneuver the power wheelchair into the securement position if they are capable.



Tilt 'n Space Wheelchair

These wheelchairs require additional securement straps. If this wheelchair is tilted more than 20 degrees, the shoulder belt won't work correctly. Students in these types of wheelchairs should be loaded in them and if possible, transfer the student to a regular seat in the school bus.



WC 19 Wheelchairs

1. WC19 wheelchairs meet voluntary standards for design, testing, and labeling. The WC19 standard is designed to work in combination with the standard for wheelchair tie-downs and occupant restraints. It provides for the use of crash-tested, four-point, strap-type tie-downs and three-point occupant restraint over the torso and pelvis.
2. A WC19-compliant wheelchair is strong enough to provide

effective support for the wheelchair rider in a wide range of crash and emergency vehicle maneuvers.

3. It also makes it faster and easier to secure the chair because it has four clearly marked and easy to reach securement points where tie-down hooks and straps can be attached.
4. If a WC19 wheelchair is not available, the next best choice is a wheelchair with an accessible metal frame to which tie-down straps and hooks can be attached at frame junctions.

[PN Online: Crash-Tested Wheelchairs](#)

WC19 Wheelchair Symbols

If you do not have a WC19 wheelchair, it is best to attach the tie-down hooks or straps to welded junctions of the frame or to other structural areas where the frame is fastened together with hardened steel bolts – often indicated by six raised lines or bumps on the bolt head. [National School Transportation Specifications and Procedures](#), (pg. 445)

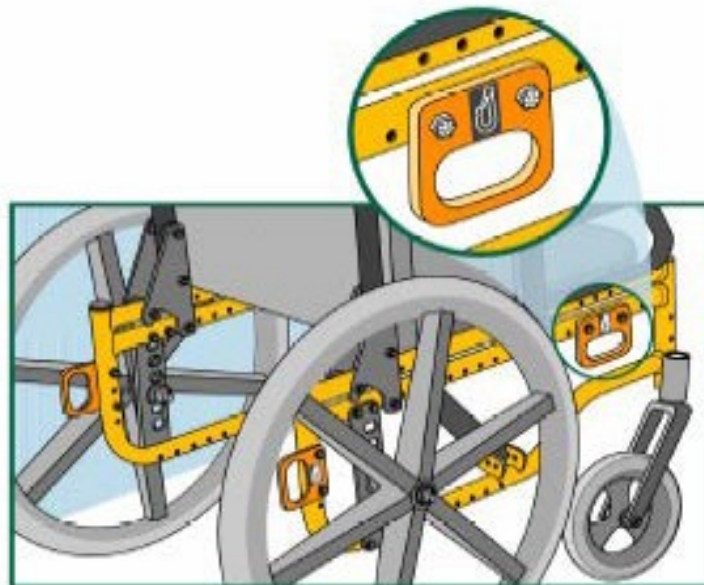

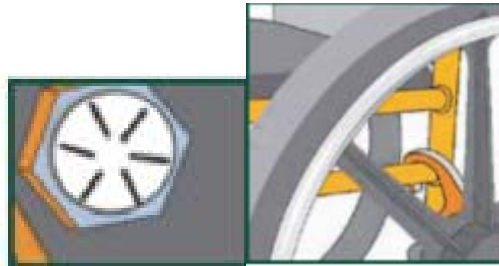

WHEELCHAIR LIFTS

Components of a Wheelchair Lift

1. Platforms;
2. Outboard roll stop;
3. Inboard roll stop;
4. Hand rails;
5. Vertical arms;
6. Top and bottom parallel arms;
7. Base plate; and
8. Hydraulic pump with manual backup.

Wheelchair Lift Safety Features

There are several safety features on the wheelchair lift.

1. The outboard roll stop which is activated by the up and down buttons:
 - a. When the up button is pushed, the outboard roll stop rotates to the vertical position before the platform rises; or
 - b. When the down button is pushed, the outboard roll stop does not rotate to the horizontal position until the platform is lowered fully to the ground.
2. The inboard roll stop position is also activated by the up and down buttons:
 - a. When the down button is pushed, the inboard roll stop rotates to a vertical position;
 - b. It remains in the vertical position while the wheelchair is loaded or unloaded on the ground; and
 - c. When the up button is pushed, the inboard roll stop rotates to the horizontal position when the platform reaches the vehicle floor level.
3. The bridge plate rotates to the horizontal position when the unfold button is pushed. It rotates to the vertical position when the fold button is pushed.
4. Interlock devices prevent operation of the lift or the school bus when it is not safe. Interlock devices can work in a variety of ways:
 - a. Locks the school bus transmission in place when the lift is deployed;
 - b. Doesn't allow the lift to be deployed until the school bus is in PARK and the emergency brake is set; and
 - c. Stalls the school bus engine if the lift is deployed and the emergency brake is released or the transmission is shifted from PARK.
5. Discontinue operation immediately if any of these safety features

do not work properly.

[National Highway Traffic Safety Administration, In-Service Safety Series](#) (Section V Loading and Unloading)

Wheelchair Lift Out-of-Service

1. The wheelchair lift does not function or is inoperable;
2. Any hydraulic line leaks during operation;
3. The wheelchair lift whose brake interlock system is non-operational;
4. The wheelchair lift platform barrier/roll stop is non-operational;
or
5. The wheelchair restraint system is not secured to the bus.

[Nevada School Bus Out-of-Service Criteria](#)



Who Can Use a Wheelchair Lift

Wheelchair lifts are designed to be used by:

1. Anyone using a wheelchair or other mobility aid;
2. Someone sitting in a folding chair;
3. A person who has difficulty using steps (for example someone using a walker, crutches, braces or a cane);

4. Due to liability, schools should never allow someone to stand on a lift;
5. A loaner wheelchair or a stroller must be used for lift use;
6. Lift attendants/bus aides cannot ride on the platform lift with the student.
7. If you experience a power or equipment failure and you have a child on the lift, you can operate the lift manually.
[National Highway Traffic Safety Administration, In-Service Safety Series](#), (Section V Loading and Unloading)

LOADING AND SECURING THE WHEELCHAIR

Loading, securing and unloading students with special needs requires more than one person. In all cases, the school bus driver is responsible for safely loading, securing and unloading students safely.

School Bus Position

You must position your school bus in the correct position before using the wheelchair lift.

1. Before using the wheelchair lift, park the vehicle on level ground. Do not park on a slope.
2. Remember that the platform must rest completely on the ground. Choose a place without obstacles to interfere with the operation of the lift; and
3. Review the operation of the interlock device on your school bus.
[National Highway Traffic Safety Administration, In-Service Safety Series](#) (Section V Loading and Unloading)

Loading the Wheelchair

1. Remember to tell the student what you are going to do before you do it.

2. Open and secure the lift door.
3. Use the hand-held control to activate the unfolding of the platform.
4. Lower the platform until it rests entirely on the ground.
5. Unfold the outboard roll stop.
6. Fasten the wheelchair seat belt around the student.
7. Back the student onto the lift. Always face the student away from the school bus.
8. Student's using a motorized wheelchair cannot drive onto the lift. Disengage the motor and push the chair onto the platform manually.
9. Lock the wheelchair brakes.
10. Turn off the wheelchair power. In some cases, the motor must be disengaged to secure the wheelchair.
11. Make sure the roll stops are in the completely up position.
12. Have the student hold onto the handrails if able.
13. Tell the student to keep arms and legs within the lift area and clear of moving parts.
14. Never ride the power lift with students on it.
15. Operate the lift controls by:
 - a. Standing next to the platform at the front corner; and
 - b. Keep one hand on the wheelchair as it is raised and operate the controls with the other hand.
16. When the platform reaches the floor level, set down or hang up the controls.

17. Release the wheelchair brakes and push the wheelchair into the bus.
18. Set the wheelchair brakes.
19. Fold the lift into the travel position.
20. Position the student according to the IEP. The IEP should specify whether to transfer the student to a forward facing school bus seat or whether to secure the wheelchair and the student.
21. Never allow students to operate the lift.
[National Highway Traffic Safety Administration, In-Service Safety Series](#) (Section V Loading and Unloading)

Placement of Students

Where you seat the students on your school bus should not be haphazard.

1. You should think about and lay out a seating plan for your school bus. Some things you should consider when developing a seating plan include:
 - a. Your route and the order in which students are loaded and unloaded at home and at school;
 - b. The medical conditions of the student;
 - c. Evacuation;
 - d. Behavior;
 - e. Supervision;
 - f. The age of the student; and
 - g. Your ability to observe the student.
2. When considering medical conditions, think about:

- a. Students who are medically fragile or vulnerable and who need to sit further front where there is less bounce;
 - b. Students who are prone to seizures in certain light conditions;
 - c. Younger students and those in child safety seats who need to sit in the first few seats;
 - d. Student with respiratory conditions who need to sit away from the lift area and away from rear windows near exhaust. Changes in temperature also tend to bother these students; and
 - e. Students who may need to sit over wheel wells for additional lower extremity support.
3. When considering evacuation, think about:
- a. Which students can evacuate themselves;
 - b. Which students can help;
 - c. Which students can help others;
 - d. Which students are in child safety seats:
 - ✓ Who should not be in emergency exit rows; and
 - ✓ Should not be in aisle seat with students who are unrestrained seated in the window seat.
4. Which students are compatible and which are not;
5. Which students need supervision either for behavior or for a medical condition;
6. Put your plan in writing, which will be especially helpful for a substitute driver.
- [National Highway Traffic Safety Administration, In-Service Safety Series](#) (Section V Loading and Unloading)

Federal Standards for Wheelchair Securement Systems

1. [Federal Motor Vehicle Safety Standard 571.222, School Bus Passenger Seating and Crash Protection](#) has specific requirements for wheelchair securement and wheelchair occupant restraint systems.
2. Remember that there is a difference between the seat belt (used for occupant restraint) and a postural aid or pelvic belt (used to hold in or to hold erect a student with a particular disability).
3. Do not jerry-rig a securement for a wheelchair.
4. Use only approved 4-point tie-down systems.
5. Do not interchange systems. Use only one manufacturer's tie-down system for each wheelchair.
6. Never place a wheelchair in front of an emergency exit door even if the wheelchair securement position is provided in that location.
[National Highway Traffic Safety Administration, In-Service Safety Series](#) (Section V Loading and Unloading)

Securing the Wheelchair

1. Center the wheelchair with the anchorages on the floor. Leave room for the rear belt to be secured at a 45-degree angle from the floor.
2. Set the wheelchair brakes on both sides and/or turn off the wheelchair power.
3. Attach the wheelchair straps to the wheelchair at 4 points:
 - a. Attach the straps along the wall first;
 - b. Then attach the straps along the aisle;
 - c. Attach the straps properly;

- d. Do not attach the straps to the wheels or any detachable portion of the wheelchair;
- e. Don't let the straps bend around any object. They should have a clear path from the floor to the wheelchair frame;
- f. Keep the straps away from sharp edges or corners;
- g. Do not crisscross or twist the straps;
- h. Make sure belts are at a 30 to 60-degree angle; a 45-degree angle is best;
- i. Never use the 4-point system without also using the 3-point lap and shoulder belt.
- j. Make sure that the wheelchair doesn't have forward or reverse movement; and
- k. If you can't get the wheelchair secured properly, contact dispatch.



- 4. Attach the 3-point system to secure the student's pelvis and torso:
 - a. Position the lap belt over the pelvic bone, not the abdomen;
 - b. Position the lap belt inside the arm rests between the side panels and the cushion;
 - c. Adjust the belt so it is snug;

- d. Position the shoulder belts so it does not cross the student's face or neck;
- e. Never position the shoulder belt under the student's arm where it would cross the rib cage;
- f. Adjust the shoulder belt to achieve firm but comfortable tension; and
- g. Never twist belts, the belts should always lie flat against the body.

[National Highway Traffic Safety Administration, In-Service Safety Series](#) (Section V Loading and Unloading)



To protect the rider during a crash or sudden braking, both a lap and shoulder belts must be used.

Never crisscross securement straps.



The front tie-down straps should anchor to the floor at points that are spaced wider than the wheelchair.



The rear anchor points for the rear tie-down straps are located directly behind the rear securement points on the wheelchair.

The diagonal shoulder belt should cross the middle of the shoulder and center of the chest and connect to the lap belt near the hip.

The Do and Do Nots of Securing a Wheelchair

1. **Do** attach the tie-down straps to welded junctions of the wheelchair frame or to other structural areas where the frame is fastened together with hardened steel bolts indicated by six raised lines or bumps on the bolt head.



2. **Do not** attach tie-downs to adjustable moving or removable parts of the wheelchair such as armrests, footrests and heels!

3. **Do** choose structural securement points closest to the seat surface as possible to provide greater wheelchair stability during travel.
4. **Do** pick rear securement points that are high enough to result in angles of the rear tie-down straps between 30 and 45 degrees to the horizontal.
5. **Do not** mix wheelchair securement points between the seat and base.
6. **Do not** mix or interchange securement systems.

When properly secured, there is no allowable movement of a wheelchair!

Other Important Points

1. Read and follow all manufacturers' instructions.
2. It is best to ride with the wheelchair backrest positioned at an angle of 30 degrees or less to the vertical. If a greater recline is needed, the shoulder belt anchor point should be moved rearward along the vehicle sidewall so the belt maintains contact with the rider's shoulder and chest.
3. Maximize the clear space around the rider to reduce the possibility of contact with vehicle components and other passengers in a crash. Cover rigid vehicle components that are close to the rider with dense padding.
4. Check wheelchair and WTORS equipment regularly and replace worn components.
5. Keep WTORS anchorage track free of debris.
6. If possible, remove hard trays and secure them in the vehicle to reduce the chance of rider injury from contact with the tray.
7. A properly positioned headrest may help protect the neck in

a rear impact.

8. If it is necessary use a head and neck support during travel, the soft collar should not be attached to the seating system.
9. Secure medical and other equipment to the wheelchair or vehicle to prevent it from breaking loose and cause injuries in a crash. [National School Transportation Specifications and Procedures](#), (pg. 446)

GENERAL GUIDELINES FOR DRIVER'S OF STUDENTS WITH SPECIAL NEEDS

Transporting students with disabilities is far more difficult than transporting their non-disabled peers. There are some general guidelines that will help you when transporting students with special needs.

1. Know about your students and what they need.
2. Know where important information is located:
 - a. The route;
 - b. Manufacturer's instructions for lifts and securement systems;
 - c. The seating plan;
 - d. Emergency information;
 - e. DNR (Do Not Resuscitate) orders;
 - f. Special medical information; and
 - g. Emergency equipment (fire extinguishers, first aid kit, seat belt cutter, etc.).
3. Exercise universal precautions at all times.
4. Do not use a wheelchair lift without another experienced driver or aide.

5. Only do what is within your technical expertise. There are lots of other resources to assist you.
6. Don't rush, take your time.
7. When I doubt, ask.

Emergency Evacuation Drills

1. Nevada law requires that school bus evacuation drills be conducted at least two times per year, at the beginning of any field trip or activity, including helping passengers evacuate the school bus. [Nevada Revised Statue 386.815](#) and [National Transportation Safety Board Safety Recommendation, Oakland Iowa](#)
2. All students, including students with special needs are required to participate in the drills.
3. The National Transportation Safety Board recommends
4. Make sure your instructions are simple, and repeat them when necessary.

Emergency Evacuation Plan

Every school bus driver who has students with special needs need to think about how to evacuate those students. When preparing the evacuation plan consider the following:

1. Which students can come off the school bus by themselves;
2. Which students can help other students off the school bus;
3. Which students can be removed from the bus without their wheelchair or specialized seat or child safety seat;
4. Which students must not be removed from their wheelchair or specialized seat or child safety seat;

5. Which students have essential equipment that also must be removed;
6. What equipment do you need for an evacuation (belt cutter, fire blanket, first-aid kit, body fluid clean-up kit,); and
7. Where are emergency services along your route (fire stations, hospitals, police).
[National Highway Traffic Safety Administration, Emergency Situations](#)

General Rules on How to Handle an Emergency

Here are some general rules for how to handle an emergency:

1. Stay calm. Students may panic and become uncontrollable if the sense fear or anxiety;
2. Stop as soon as possible in a safe place, usually off the traveled roadway, preferable in a parking lot or driveway;
3. Secure the vehicle by putting the transmission in PARK, set the emergency brake and turn off the ignition;
4. Take the keys;
5. Contact dispatch;
6. Contact 911 for a serious medical emergency;
7. If necessary, use warning devices to alter other motorists you are stopped; and
8. If you must evacuate:
 - a. Explain what you are doing using simple, concise directions;
 - b. Use all exits if possible; and
 - c. Once students are off the school bus, move them to a safe place away from the school bus.

Lift Techniques for Evacuating Students

1. There are several techniques you need to know to get students with special needs out of the school bus in an emergency:
 - a. The one-person lift;
 - b. The two-person lift; and
 - c. The blanket drag.
2. General lifting guidelines include:
 - a. Never lift anymore more than half your weight;
 - b. Test your lifting ability with a small movement that can be stopped; and
 - c. If the student weighs too much, use another method.
3. General lift guidelines:
 - a. Clear the path to the exit;
 - b. Tell the student exactly what you are going to do before you do it;
 - c. If necessary, cut the seat belt and other positioning straps;
 - d. Stand balanced with your feet shoulder width apart and face the student or face in the direction you want to go, if possible;
 - e. Get a good grip on the student of the student's clothing, use your palms, not just your fingers;
 - f. Squat down but keep your heels off the floor;
 - g. Get as close to the student as you can;

- h. Lift gradually (without jerking) using your leg, abdominal, and buttock muscles;
- i. Keep the student as close to you as possible;
- j. Keep your chin tucked in so as to keep a relatively straight back and neck line;
- k. Once you are standing, check directions by pointing your feet in the direction you want to go and turning your whole body;
- l. Avoid twisting at your waist while carrying a student;
- m. Take small steps, keeping the student close to your body.
- n. For students with poor muscle control, curl the student as much as possible to keep the student's arms and legs from flopping and support the student's head and neck.

4. General procedures for a one-person lift:

- a. Follow general lift guidelines;
- b. Pass the student's near arm over your shoulder;
- c. Place one of your arms behind the student's shoulders with your hand under the student's other arm;
- d. Place your other arm under the student's knees;
- e. Squat down with feet should width apart; and
- f. Lift the student with the load equally divided between both arms, holding the student close to you.

5. General procedures for a two-person lift:

- a. Move the student in a wheelchair as close to the exit as possible;

- b. Slide the student on a seat next to the aisle;
 - c. The taller person stands behind the student and the other person stands in front of the student and off to the side;
 - d. If the student is in a wheelchair; the person in front should remove the armrests and fold up the footrests;
 - e. The person in the back reaches under the student's arms and either:
 - ✓ Grasps right hand to student's right wrist and left hand to student's left wrist; or
 - ✓ Clasps hands across the student's chest.
 - f. The person in front lifts the lower extremities under the thighs and hips; and
 - g. Squats down and lift together on a count of three.
6. General procedures for a blanket drag:
- a. Using a blanket reduces stress on the student's body and the chance of injury;
 - b. The blanket drag is also a way to move heavier students or fragile students who might be hurt by lifting;
 - c. The blanket drag is not a good choice for students who are medically fragile;
 - d. Follow general lifting guidelines;
 - e. Fold a blanket in half and place it on the floor next to the student;
 - f. Lower the student's legs onto the blanket first, then the head. Make sure to place the student's head toward the exit;
 - g. Wrap the blanket around the student to prevent arms and

legs from being caught on obstacles; and

- h. Grasp the blanket near the student's head and drag the student to the exit.

[National Highway Traffic Safety Administration, Emergency Situations](#)

BUS AIDES AND ATTENDANTS

Bus aides and attendants provide assistance to students and the bus driver and must be trained on the special circumstances required to transport students with special needs. Bus aides and attendants will need to know:

1. How the IEP process works;
2. Your school district's policy for confidentiality of student information;
3. Legal issues, including federal and state laws, administrative rules and school district policies and procedures for special education students; and
4. Policies and procedures for:
 - a. Loading and unloading students with special needs;
 - b. Evacuation procedures, including the use of emergency equipment;
 - c. Lifting and positioning procedures for evacuating special needs students;
 - d. Behavior management, including procedures for dealing with inappropriate or unacceptable student behavior;
 - e. Knowledge in first-aid and CPR, including universal standards for the spread of contagious and communicable diseases, blood borne pathogens and universal precaution procedures;
 - f. Policies and procedures for detecting and reporting neglect or abuse; and

- g. Policies and procedures for student's medicine and other articles that may have been left on the bus after an evacuation.

The school bus driver is ultimately responsible for assuring that all students are properly secured.

EXTENDED SCHOOL YEAR (ESY)

Extended school year services are services for special education students that extend beyond the normal school year in accordance with a student's IEP.

SECTION 13: TRANSPORTING TODDLERS AND PRE-SCHOOL CHILDREN

INTRODUCTION

In the State of Nevada, school districts are not required to provide transportation to students under the age of 3. With the new early childhood education programs in Nevada, schools are now transporting 3-5 year olds in school buses.

Preschool children are the youngest, most vulnerable passengers on school buses. They depend on transportation personnel to provide a safe ride to and from early childhood education programs.

Transportation providers need to be knowledgeable and develop skills to adequately provide for the safety of young children while being transported on school buses. Infants, toddlers and pre-school children with special physical, cognitive or behavioral needs present new challenges and responsibilities for transportation providers. These children require a great deal of supervision during the time they are in the school bus.

1. Some issues that must be addressed to assure safe transportation in the school bus include:
 - a. Physical handling;
 - b. Communication with young children;
 - c. Behavior management;
 - d. Child safety seats;
 - e. Restraint systems;
 - f. Safety vests;
 - g. Wheelchairs and occupant securement systems;
 - h. Special equipment management;

- i. Medically fragile conditions;
- j. Personnel training; and
- k. Parental responsibilities.

DEFINITIONS

1. A **newborn** is a child from birth to one month.
2. An **infant** is a child from one month to one year.
3. A **toddler** is a child from one year to three years.
4. A **preschooler** is a child from three years to five years of age.

Note: Individual programs may have variations in how these four terms are used.

TRANSPORTATION SERVICES FOR PRESCHOOL CHILDREN WITH DISABILITIES

1. The Individualized Family Service Plan (IFSP) under Part C of IDEA addresses the unique needs of infants and toddlers with disabilities and their families.
2. The IFSP process has two main parts:
 - a. The IFSP meeting, where parents and interagency personnel jointly make decisions about an eligible child's early intervention services; and
 - b. The IFSP document itself, which is a written plan for the provision of early intervention services for the child and family.

DRIVER AND AID KNOWLEDGE AND RESPONSIBILITY

As a school bus driver and a school bus aid, there is additional knowledge and responsibility when transporting pre-school age children. In addition to their regular duties, you will be responsible for:

1. General knowledge about the development of young children, including specific disability conditions.
2. Age-appropriate physical handling, communication and behavior management of young children.
3. Appropriate use of all the equipment (e.g., power lifts, child restraint systems, safety vests, wheelchairs, securement devices/occupant restraints and safety belts).
4. Loading and unloading of children who are ambulatory or non-ambulatory.
5. Evacuation and evacuation drills.
6. Knowledge about transportation requirements on a child's IFSP or IEP, including confidentiality.
7. Knowledge about special needs on the vehicle.
8. Knowledge about child protection laws (e.g., abuse and neglect).
9. Effective communication skills with school staff, students, parents, law enforcement officials and the motoring public.

CHILD SAFETY RESTRAINT SYSTEMS (CSRS)

Car seats used on school buses must be appropriate for the individual child and must be used correctly. All of the restraint systems used for transportation must be secured to the bus seat in the manner prescribed and approved by both the school bus manufacturer and CSRS directions.

Elements to Correctly Install CSRS

It is recognized that compartmentalization, the passive safety system required on school buses under FMVSS 222, provides a higher level of safety to children over 40 pounds without diagnosed medical complexities or fragility than to children who might require special securement or positioning.

1. **Direction.** Position (rear or forward-facing) and adjust recline angle accordingly.
2. Use the correct belt path on the CSRS as directed by the manufacturer's instructions.
3. **Installation.** To achieve tight installation, place adult's full weight into the seat of the CSRS to compress the vehicle seat cushion. Pull the safety tight, buckle and lock the safety belt. The CSRS should not move more than 1-inch forward or side to side.
4. Rear-Facing CSRS (infant only).
 - a. These seats are designed for infants from birth to twenty pounds (manufacturer's instructions) and one year of age, usually less than 26 inches in length.
 - b. The rear-facing position at a 45 degree recline supports the infant's head, neck and back. Harness straps must be at or below the infant's shoulders.
 - c. Harness straps must be snug (allow only one finger of space under the harness at the collar bone) and must lie flat (not twisted).
 - d. The harness retainer clip, which is designed to hold the harness straps in place, should always be placed at armpit level. Avoid any extra padding or blankets behind or beneath the infant.

Convertible CSRS (Rear-Facing)

1. Rear-facing infant position is designed for babies from birth to twenty pounds, and one year of age (manufacturer's instructions) and usually less than 26 inches in length.
2. The rear-facing position at a 45 degree recline supports the infant's head, neck and back.
3. The harness straps must be at or below the infant's shoulders.

4. Harness straps must be snug (allow one finger of space under the harness at the collar bone) and lie flat (not twisted).
5. The harness retainer clip, which is designed to hold the harness straps in place, is always at armpit level.
6. Avoid any extra padding or blankets behind the infant.
7. Avoid the use of a T-shield or tray shield with infants.

Note: There are several CSRSs that ride rear-facing to thirty pounds to accommodate the larger infant and to comply with NSTSA's Guideline for the Safe Transportation of Pre-School Age Children in School Buses."

Convertible CSRS (Forward-Facing).

1. Forward-facing CSRS with five-point harness, T-shield or tray shield are designed for children above twenty pounds to sixty pounds.
2. The seat should be adjusted to the upright position.
3. Harness straps must be in the upper slot (at or above the child's shoulders).
4. The seat may be used until the child's ears are above the back of the shell.
5. Harness straps must be snug (allow one finger of space under the harness at the collar bone) and lie flat (not twisted).

Note: There are some CSRS's that cannot be installed properly in a twenty-inch bus seat (i.e., tray-shield).

Car Beds

1. A car bed is for preschoolers and an infant up to 20 pounds allows the infant to lie flat. The use of a car bed must be approved by qualified personnel at an IFSP team meeting.

2. Lateral support can be added at both sides of the infant. Avoid placing padding around the infant's head to prevent airway blockage.
3. Beds must be secured to the bus seat, with the seat belt passing through both slide loops.
4. Adjust the harness system to a snug fit as specified by the manufacturer. Harness straps should lie flat (not twisted).
5. Caution should be given to gastrostomy tubes, tracheotomies and shunts.

Specialized Positioning Seats

1. These seats are used only when a child does not fit in a standard CSRS nor has a particular condition warranting more support.
2. The seat may require an additional tether strap to secure the seat to a bus seat.
3. The safety belt must be routed through the appropriate belt path specified by the manufacturer's instructions to secure the CSRS.
4. If a retainer clip is used, it must be positioned at armpit level.
5. Caution should be given to gastrostomy tubes, tracheotomies, and shunts.

Booster Safety Seats (Belt Positioning Boosters Only).

A booster seat should be used only if children are between 40 and 80 pounds and must be used in conjunction with a lap-shoulder belt.

Safety Vests

1. Vest selection should be appropriate for the height, weight, and waist of the child. Proper fit must account for seasonal changes in clothing.

2. The decision to use a vest should be made by an IFSP or IEP team that includes qualified personnel and the parents.
3. The use of safety vests should be noted on the IFSP or IEP.
4. The decision to use vests for wheelchair usage must be made by an IFSP and IEP team that includes qualified personnel and the parent and should be noted on the IFSP or IEP.
5. Caution should be given to gastrostomy-tubes, tracheotomies and shunts.
6. Child may have a tendency to slide under the vest/safety belt or submarine and should be securely fitted with a crotch strap supplied by the manufacturer.
7. If unrestrained students share the seat with a student in a child safety restraint, the student using the restraint should be placed in a window-seating position.
8. The seat behind the child in a vest should be kept empty or occupied by a child who is also in a child safety restraint system.
9. Portable seat mounting straps should be checked for proper fit by transportation personnel during pre-trip inspection.
10. Get parent/guardian signature prior to the use of safety vests.

EMERGENCY EVACUATION PROCEDURES FOR INFANTS, TODDLERS AND PRESCHOOL AGE CHILDREN

Because infants, toddlers and pre-school age children must be transported in Child Safety Restraint Systems (CSRS's), a plan will need to be established with regard to emergency evacuations.

Emergency evacuation procedures require that the children be individually loaded and unloaded.

In the event of an emergency, there will need to be:

1. A written plan on emergency evacuation procedures for infants, toddlers and pre-school age children who are secured in Child Safety Restraint Systems (CSRSs).
2. Emergency evacuation drills are practiced on a scheduled basis, at least as often as required for other school age children.
3. Personnel involved in transporting children in CSRSs should be trained in evacuation and emergency procedures.
4. All school buses carrying children in CSRSs carry safety belt cutters that are accessible only to the driver and any assistants.
5. CSRSs should not be placed in school bus seat adjacent to emergency exit.

ACRONYMS

1-2-3	1=Applied Test, 2=Emergency Warning Device, 3=Pump down to check for pop out.
ADD	Attention Deficit Disorder
ADHD	Attention Deficit Hyperactivity Disorder
BAC	Blood Alcohol Concentration
BP	Blood Pressure
CDL	Commercial Driver's License
CLP	Commercial Learners Permit
CDLIS	Commercial Driver's License Information System
CFR	Code of Federal Regulations
CMV	Commercial Motor Vehicle
CNG	Compressed Natural Gas
CSRS's	Child Safety Restraint Systems
DEF	Diesel Exhaust Fluid
DHS	Department of Homeland Security
DMV	Department of Motor Vehicles
DOC	Diesel Oxygenation Catalyst
DOT	Department of Transportation
DNR	Do Not Resuscitate
DRL	Daytime Running Lamps
ECP	Exposure Control Plan
EHA	Education of the Handicapped Act
ELDT	Entry Level Driver Training
ESY	Extended School Year
FAPE	Free and Appropriate Education
FERPA	Family Educational Rights & Privacy Act
FET	F=Fuses, E=Emergency, T=Triangles
FMCSA	Federal Motor Carrier Safety Administration
FMCSR	Federal Motor Carrier Safety Regulations
FMVSS	Federal Motor Vehicle Safety Standards
GVW	Gross Vehicle Weight
HBV	Hepatitis B Virus
HIV	Human Immunodeficiency virus
HOV	High-Occupant Vehicles
I-C-D	I=Inflation, C=Condition, D=Tread Depth
IED	Improvised Explosive Device
IDEA	Individuals with Disabilities Education Act
IEP	Individual Education Plan

IFSP	Individual Family Support Plan
LEA	Local Education Agencies
LRE	Least Restrictive Environment
NHTSA	National Highway Traffic Safety Administration
NAC	Nevada Administrative Code
NRS	Nevada Revised Statutes
NSST	National Standards for School Transportation
NTSB	National Traffic Safety Board
OSA	Obstructive Sleep Apnea
OSHA	Occupational Safety & Health Act
PSI	Pounds per Square Inch
SAE	Society of Automotive Engineers
WTORS	Wheelchair Tie-down Occupant Restraint System